



The ibidi product family is comprised of a variety of μ-Slides and μ-Dishes, which have all been designed for high-end microscopic analysis of fixed or living cells.

The glass bottom versions of the μ-Slides and μ-Dishes are especially designed for TIRF, super resolution and single molecule applications. The μ-Slide 4 well<sup>Ph+</sup> (Phase contrast plus) is an array of 4 square fields where cells can be cultivated and investigated with microscopical methods. The μ-Slide 4 well<sup>Ph+</sup> improves the optical quality of phase contrast microscopy. In contrast to the classic μ-Slide 4 well, the Ph<sup>+</sup> version provides a special plate in the center of the wells. This plate suppresses

the meniscus which is disturbing the phase contrast effect in normal open wells. Openings near the corners provide access to the wells for filling and aspirating liquids easily.

## Material

The μ-Slide 4 Well<sup>Ph+</sup> Glass Bottom is made with a glass coverslip bottom. It is not possible to detach the bottom. The μ-Slide 4 Well<sup>Ph+</sup> Glass Bottom is not autoclavable since it is temperature stable only up to 80°C/175°F.

## Geometry

The μ-Slide 4 Well<sup>Ph+</sup> Glass Bottom provides a standard slide format according to ISO 8037/1.

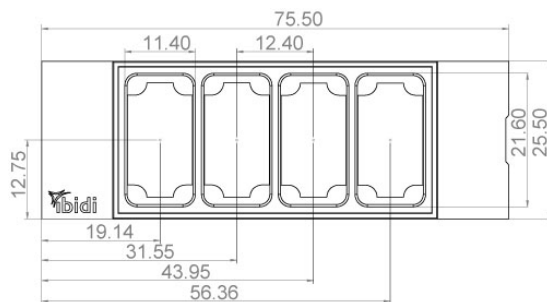

### Geometry of the μ-Slide 4 Well<sup>Ph+</sup> Glass Bottom

Outer dimensions in mm (w × l)	25.5×75.5
Number of wells	4
Dimensions of wells in mm (w × l × h)	21.6 × 11.4 × 3.0
Volume per well	700 μl
Liquid height	3.0 mm
Total height with lid	10.8 mm
Growth area per well	2.5 cm <sup>2</sup>
Coating area per well	5.9 cm <sup>2</sup>
Bottom	Glass Bottom

## Shipping and Storage

The μ-Slides, μ-Dishes and μ-Plates are sterilized and welded in a gas-permeable packaging. The shelf life under proper storage conditions (in a dry place, no direct sunlight) is listed in the following table.

Conditions	
Shipping conditions	Ambient
Storage conditions	RT (15–25°C)
Shelf Life	
Glass Bottom	36 months

### Optical Properties ibidi Glass Bottom

Refractive index $n_D$	1.523
Abbe number	55
Thickness	No. 1.5H (selected quality) 170 μm, ± 5 μm
Material	Schott borosilicate glass, D 263M

### Attention!

Be cautious when handling ibidi labware products with glass bottom! The glass coverslip or glass slide is very fragile and might break easily. Handle with care to avoid physical injury and damage to devices through leakage of the medium.

## Surface

The μ-Slide 4 Well<sup>Ph+</sup> Glass Bottom is manufactured with an uncoated glass coverslip. Washing steps (e.g. with PBS) before cell seeding can remove glass dust which is advantageous for direct cell growth on the surface.

## Coating

Detailed information about coatings is provided in [Application Note 08: Coating protocols for ibidi labware products](#).

In short, specific coatings are possible following this protocol:

1. Prepare your coating solution according to the manufacturer's specifications or reference.
2. Apply 700 μl and leave at room temperature for at least 30 minutes.
3. Aspirate the solution and wash with the recommended protein dilution buffer.
4. The μ-Slide 4 Well<sup>Ph+</sup> Glass Bottom is ready to be used. Optionally let dry at room temperature. Attention, some coating proteins might degenerate when drying!

## Seeding Cells

- Trypsinize and count cells as usual. Dilute the cell suspension to the desired concentration. Depending on your cell type, application of a  $5-11 \times 10^4$  cells/ml suspension should result in a confluent layer within 2–3 days.
- Apply 700 μl cell suspension into each well of the slide. Avoid shaking as this will result in inhomogeneous distribution of the cells.
- Cover the slide with the supplied lid. Incubate at 37°C and 5% CO<sub>2</sub> as usual.

Undemanding cells can be left in their seeding medium for up to three days and grow to confluence there. However, best results might be achieved when the medium is changed every 1–2 days. Carefully aspirate the old medium and replace it by 700 μl fresh medium per well.

### Tip:

The day before seeding the cells we recommend placing the cell medium and the μ-Slide into the incubator for equilibration. This will prevent the liquid inside from emerging air bubbles over the incubation time.

## μ-Slide 4 Well Selection Guide

### μ-Slide 4 Well

Standard open wells for maximum sample access. Meniscus disturbs the beam path. Good phase contrast quality only in the center of each well.

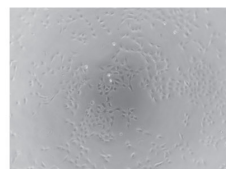
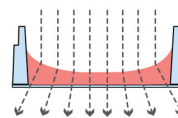
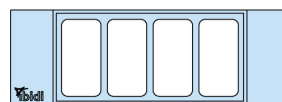
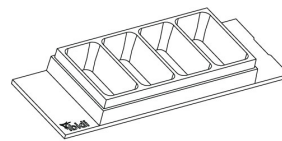

### μ-Slide 4 Well<sup>Ph+</sup>

Special plate in the center of the wells suppresses meniscus formation. No meniscus – parallel beam path. For excellent phase contrast microscopy all over the wells.

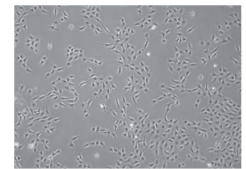
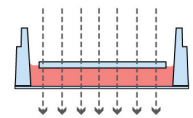
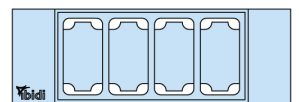
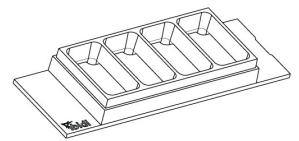

## Immersion Oil

When using ibidi Glass Bottom products with oil immersion objectives, there is no known incompatibility with any immersion oil on the market. All types of immersion oils can be used.

### Filling and Handling

Fill the wells by using a standard pipet. Inject the cell suspension directly into one of the openings. Medium exchange is easily done by aspirating the entire volume and refilling using 700 μl per well.

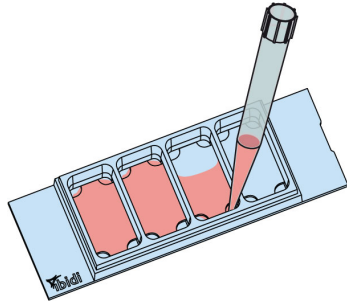

### Microscopy

To analyze your cells, no special preparations are necessary. Cells can be directly observed live or fixed, preferably on an inverted microscope. The bottom cannot be removed. For optimal results in fluorescence microscopy

and storage of fixed and stained samples, ibidi provides a mounting medium (50001) optimized for μ-Dishes, μ-Slides, and μ-Plates.

### Chemical Compatibility

The following table provides some basic information on the chemical and solvent compatibility of the μ-Slide 4 Well<sup>Ph+</sup> Glass Bottom. For a full list of compatible solvents and more information on chemical compatibility, please visit the FAQ section on [ibidi.com](http://ibidi.com).

Chemical / Solvent	Compatibility
Methanol	yes
Ethanol	yes
Formaldehyde	yes
Acetone	no
Mineral oil	yes
Silicone oil	yes
Immersion oil	See <b>Immersion Oil</b> on page 2.

## Ordering Information

The μ-Slide 4 Well<sup>Ph+</sup> Glass Bottom is available as open well and as a Ph+ version. See the table below for choosing your μ-Slide 4 Well<sup>Ph+</sup> Glass Bottom.

### μ-Slide 4 Well

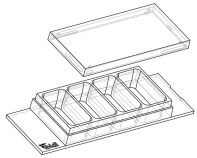

Cat. No.	Description
80426	μ-Slide 4 Well ibiTreat: #1.5 polymer coverslip, tissue culture treated, sterilized
80422	μ-Slide 4 Well Collagen IV: #1.5 polymer coverslip, sterilized
80424	μ-Slide 4 Well Poly-L-Lysine: #1.5 polymer coverslip, sterilized
80421	μ-Slide 4 Well Uncoated: #1.5 polymer coverslip, hydrophobic, sterilized
80427	μ-Slide 4 Well Glass Bottom: 1.5H (170 μm ±5 μm) D 263 M Schott glass, sterilized

### μ-Slide 4 Well<sup>Ph+</sup>



Cat. No.	Description
80446	μ-Slide 4 Well <sup>Ph+</sup> ibiTreat: #1.5 polymer coverslip, tissue culture treated, sterilized
80442	μ-Slide 4 Well <sup>Ph+</sup> Collagen IV: #1.5 polymer coverslip, sterilized
80444	μ-Slide 4 Well <sup>Ph+</sup> Poly-L-Lysine: #1.5 polymer coverslip, sterilized
80447	μ-Slide 4 Well <sup>Ph+</sup> Glass Bottom: 1.5H (170 μm ±5 μm) D 263 M Schott glass, sterilized

## For research use only!

Further information can be found at [www.ibidi.com](http://www.ibidi.com). For questions and suggestions please contact us by e-mail [info@ibidi.de](mailto:info@ibidi.de) or by telephone +49 (0)89/520 4617 0.

© ibidi GmbH, Lochhamer Schlag 11, 82166 Gräfelfing, Germany.