



# Instruction Manual

## ibidi Heating System, Universal Fit, for 4 $\mu$ -Slides

---

*Version 2.0*



10927 ibidi Heating System, Universal Fit, for 4  $\mu$ -Slides  
10928 Heated Plate, Universal Fit, for 4  $\mu$ -Slides



## **Contact**

### **ibidi GmbH**

Lochhamer Schlag 11  
82166 Gräfelfing  
Germany

Phone: +49 89 / 520 46 17 - 0

Fax: +49 89 / 520 46 17 - 59

E-mail: [info@ibidi.de](mailto:info@ibidi.de)

Internet: [ibidi.com](http://ibidi.com)

## Contents

<b>1 Preamble</b>	<b>7</b>
1.1 Introduction . . . . .	7
1.2 Safety Symbols . . . . .	7
1.3 Nomenclature . . . . .	8
1.4 Specifications . . . . .	8
1.5 Disclaimer . . . . .	10
1.6 Safety Considerations . . . . .	10
1.7 Limited Warranty . . . . .	12
1.8 Transporting the ibidi Heating System, Universal Fit . . . . .	12
1.9 Repairing the ibidi Heating System, Universal Fit . . . . .	13
1.10 Waste Disposal – WEEE/RoHS Compliance Statement . . . . .	13
1.10.1 EU Directive WEEE . . . . .	13
1.10.2 EU Directive RoHS . . . . .	13
1.11 Regulatory Statement . . . . .	14
<b>2 Intended Use</b>	<b>15</b>
<b>3 Principle</b>	<b>15</b>
<b>4 Equipment</b>	<b>16</b>
4.1 Components of the ibidi Heating System, Universal Fit, Universal Fit, for 4 $\mu$ -Slides . . . . .	16
4.2 Combination Options . . . . .	17
4.3 Temperature Controller . . . . .	18
4.4 Heated Lid . . . . .	19
4.5 Heated Plate and Magnetic Holder . . . . .	20

<b>5</b>	<b>Operation</b>	<b>22</b>
5.1	Installation and Connection of the Parts . . . . .	22
5.2	Start the ibidi Heating System, Universal Fit . . . . .	23
5.3	Setting Parameters in the Front Display . . . . .	23
5.3.1	Run/Stop Mode . . . . .	24
5.3.2	Incubation Parameters . . . . .	24
5.3.3	Setup Menu . . . . .	24
5.4	Temperature Adjustment in the Sample . . . . .	26
5.5	Sample Preparation . . . . .	27
<b>6</b>	<b>IncuControl Software</b>	<b>27</b>
<b>7</b>	<b>Maintenance</b>	<b>28</b>
7.1	Disinfection and Cleaning . . . . .	28
7.2	Influence of Ambient Temperature and Ventilation . . . . .	29
<b>8</b>	<b>Troubleshooting</b>	<b>29</b>
8.1	Focus not Stable . . . . .	29
8.2	Evaporation Is Too High . . . . .	30
8.3	Condensation Inside the Stage Top Incubator . . . . .	30



# 1 Preamble

## 1.1 Introduction

This manual is your guide to using the ibidi Heating System, Universal Fit for cell culture experiments on an optical microscope. It instructs first-time users how to use the instrument, and serves as a reference for experienced users.

Before using the ibidi Heating System, Universal Fit, please read this instruction manual carefully and make sure that the contents are fully understood. This manual should be easily accessible to the operator at all times during instrument operation. If this manual gets lost, order a replacement from [www.ibidi.com](http://www.ibidi.com).

To ensure safe operation, the ibidi Heating System, Universal Fit must only be operated with the supplied components and according to the instruction manual.

## 1.2 Safety Symbols

Note that the signal words **WARNING**, **CAUTION** and **NOTE** have specific meanings in this manual. Do not proceed beyond a signal word until you have performed the indicated actions.

**WARNING!** A potentially hazardous situation which, if not avoided, could result in serious injury or even death. Warning messages in the text are displayed in a gray shaded box.

**CAUTION** A potentially hazardous situation which, if not avoided, could result in minor or moderate injury. It is also used to alert against damaging the equipment or the instrument.

**NOTE** Additional information to help achieve optimal instrument and assay performance.

Symbols on the product identification label and back panel of the device:



CE Marking: This symbol indicates the product's compliance with EU legislation.



This label is positioned on the back of the device and prompts you to read the manual before using the device.



Product disposal: The symbol indicates that this product must be recycled/disposed of separately from other household waste. See page 13 for details.

### 1.3 Nomenclature



Temperature Controller

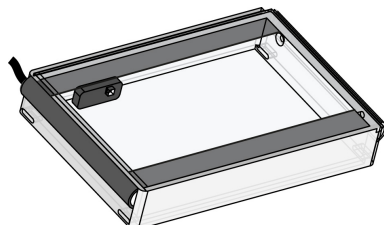

Heated Lid, Universal Fit

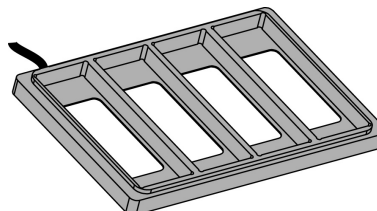

Heated Plate, Universal Fit,  
for 4  $\mu$ -Slides

### 1.4 Specifications

Only operate the Heating System in the range of the specifications given below:

Table 1 – Specifications of the ibidi Heating System, Universal Fit

<b>Electrical Specifications Power Supply</b>	
Protection class	I
International protection marking (IEC 60529)	IP 20
Oversvoltage category	II
External power supply	AC 100–240 V, 50/60 Hz, 2 A
Input line voltage	DC 24 V, 6.67 A, 160 W
Temperature Controller	
Output voltage to channel 1 (Heated Lid), Universal Fit	DC 10 V, max. 5 A
Output voltage to channel 4 (Heated Plate), Universal Fit, for 4 $\mu$ -Slides	DC 24 V, max. 5 A
<b>Operating and Storage Conditions</b>	
Operating site	Indoor use only
Operating temperature	18–30°C/64–86°F (min 5°C/9°F less than set temperature)
Operating humidity	max. 80% relative humidity (RH)
Operating altitude	max. 2000 m (atmospheric pressure 800–1060 hPa/11.6–15.4 psi)
Storage conditions	-5–50°C/23–122°F, humidity <60% relative humidity (RH)
<b>Outer Dimensions and Characteristics of the Components</b>	
Temperature Controller	90 mm × 170 mm × 230 mm Weight: 1720 g/3.8 lbs
Heated Lid, Universal Fit	19 mm × 85.5 mm × 127.5 mm (134.5 mm with cover ridge) Length of cable: 1.5 m



Table 1 – (continued)

Heated Plate, Universal Fit, for 4 $\mu$ -Slides	Connector to Gas Incubation: Female Luer Lock 12 mm $\times$ 85.5 mm $\times$ 127.5 mm Observation area: 22 mm $\times$ 49 mm per $\mu$ -Slide Length of cable: 1.5 m
Heated Plate assembled with Heated Lid	Height: 25.5 mm
USB cable	Weight: 330 g/0.46 lbs
Power supply cable	Length: 1.8 m Length: 2.0 m (power supply to wall) Length: 1.2 m (power supply to device)

**Temperature Control Range**

Heated Lid, Universal Fit	Ambient temperature (min. +18°C) to +45°C Accuracy: $\pm 0.2^\circ\text{C}$ (at sensor location) $\pm 5^\circ\text{C}$ (entire heated glass)
Heated Plate, Universal Fit, for 4 $\mu$ -Slides	Ambient temperature (min. +18°C) to +45°C Accuracy: $\pm 0.2^\circ\text{C}$ (at sensor location) $\pm 0.5^\circ\text{C}$ (entire heated plate)

**Recommended Temperatures before Adjustment**

See Section [5.4](#)

**USB Interface**

Connector type	USB 2.0 Connector Type B
Recommended USB cable	Tripp Lite UR022-006 (shielded)
Driver	FTDI VCP driver

**Microscope Requirements**

Working distance condenser	$\geq 26$ mm
Stage holder	Holder for standard multi-well plates

**Optical Properties Glass Lid**

Glass	Selected HQ Floatglass
Thickness of the glass plate	1.1 mm
Refractive index glass	$n_D = 1.520$ (588 nm)
ITO coating	Thickness: 100 nm
Passivation layer	Thickness: 20-25 nm
Refractive index ITO with passivation layer	1.95

## 1.5 Disclaimer

- ibidi shall not be held liable, either directly or indirectly, for any damage incurred as a result of product use.
- The contents of this manual are subject to change without notice for product improvement.
- This manual is considered complete and accurate at publication.
- This manual does not guarantee the validity of any patent rights or other rights.
- If an ibidi software program doesn't function properly, this may be caused by a conflict from another program operating on the computer. In this case, take corrective action by uninstalling the conflicting product(s).
- ibidi is a registered trademark of ibidi GmbH in Germany and other countries.

## 1.6 Safety Considerations

### WARNING!

- Only operate the ibidi Heating System, Universal Fit with the supplied components.
- Only use the cables and plugs delivered with the system. The power plug of the control unit must be inserted in an outlet with a ground (earth) contact.
- Do not replace detachable power cables by power cables with inadequate specifications. By violating these instructions you risk electric shock and fire.
- Only use extension cables that have a protective ground wire.
- Do not operate the ibidi Heating System, Universal Fit under conditions that pose a risk of explosion, implosion, or the release of gases. Only operate the ibidi Heating System, Universal Fit with aqueous solutions.
- Do not place flammable solids, liquids, gases, or gas outlets near the system (e.g. matches, ethanol, propane gas, solvents). Do not bring these products in contact with any other component of the system either.
- Do not operate a damaged ibidi Heating System, Universal Fit. If the housing seems damaged or something is rattling inside the controller, contact the [ibidi service hotline](#) for repair.
- Only operate the Heated Lid and Heated Plate properly installed on a microscope stage.
- Some accessible parts of the Heated Plate and Heated Lid can reach temperatures up to 55°C. Avoid touching the temperature-controlled parts of the system when you have set the Temperature Controller to high temperatures.

### CAUTION

- Ensure that the external power supply is easily accessible. The ibidi Heating System, Universal Fit must be installed in a manner such that none of its components hinders access to the external power supply.

- Immediately replace damaged cords, plugs, or cables to avoid risk of personal injury or damage to the instrument.
- Only ibidi technical staff and technical staff instructed by ibidi are permitted to open and service the ibidi Heating System, Universal Fit.
- The external power supply should not be brought into contact with moisture. If the housing is damaged, the external power supply should not be used.
- Avoid strong magnetic fields and sources of high frequency. The ibidi Heating System, Universal Fit might not function properly when located near a strong magnetic field or high frequency source.
- Avoid vibrations from vacuum pumps, centrifuges, electric motors, processing equipment, and machine tools.
- Avoid dust and corrosive gas. Do not install the ibidi Heating System, Universal Fit where it could be exposed to high levels of dust or to outside air or ventilation outlets.
- Install the ibidi Heating System, Universal Fit in a location that enables easy access for maintenance.
- Do not place heavy objects on the instrument.
- Install the Temperature Controller in a horizontal and stable position, which includes a table, bench or desk upon which the instrument is installed.
- The heated glass plates of the incubation chamber can break on mechanical impact. If so, the glass shards can lead to injuries if handled.
- Be aware that when switched on, a 10 V DC voltage is applied to the underside of the glass on the Heated Lid. Do not touch the underside or put it in contact with anything conductive. This could cause a short circuit that may damage the Temperature Controller and/or the Heating Devices.

## 1.7 Limited Warranty

Products manufactured by ibidi, unless otherwise specified, are warrantied for a period of one year from the date of shipment to be free of defects in materials and workmanship. If any defects in the product are found during this warranty period, ibidi will repair or replace the defective part(s) or product free of charge.

This warranty does not apply to defects resulting from the following:

1. Improper or inadequate installation.
2. Improper or inadequate operation, maintenance, adjustment, or calibration.
3. Unauthorized modification or misuse.
4. Use of unauthorized tubing or fluidic connectors.
5. Use of consumables, disposables, and parts not supplied by an authorized ibidi distributor.
6. Corrosion due to the use of improper solvents, samples, or due to surrounding gases.
7. Accidents beyond ibidi's control, including natural disasters.

This warranty does not cover consumables, such as cell culture chambers and dishes, tubes, fluidic connectors, reagents etc.

The warranty for all parts supplied and repairs provided under this warranty expires on the warranty expiration date of the original product.

## 1.8 Transporting the ibidi Heating System, Universal Fit

The weight of the Temperature Controller is approx. 1.7 kg/3.8 lbs. Moving the Temperature Controller during operation can pose a risk of personal injury or damage to the instrument.

For transport, switch off the Temperature Controller and then disconnect the heated components from the controller. Carry the devices carefully and avoid mechanical shocks.

### **WARNING!**

Hot surface (max. 55°C)! Do not touch Heated Lid and Heated Plate when hot. Always disconnect the instrument from the power supply before transport and leave the instrument to cool down for approx. 5 minutes.

## 1.9 Repairing the ibidi Heating System, Universal Fit

For inquiries concerning repair service, contact the ibidi service personnel and provide the model name and serial number of your system.

ibidi GmbH  
Service Hotline: [service@ibidi.com](mailto:service@ibidi.com)

### CAUTION

Do not try to repair the ibidi Heating System, Universal Fit by yourself. Disassembly of the ibidi Heating System, Universal Fit is not allowed. Disassembly poses a risk of personal injury or damage to the devices. Contact ibidi service personnel if there is a need to disassemble a device.

## 1.10 Waste Disposal – WEEE/RoHS Compliance Statement

The European Union (EU) has enacted two directives, the first on product recycling (Waste Electrical and Electronic Equipment, WEEE) and the second on limiting the use of certain substances (Restriction on the use of Hazardous Substances, RoHS).

### 1.10.1 EU Directive WEEE

The ibidi Heating System, Universal Fit must be disposed of in compliance with the WEEE Directive 2012/19/EC.



This symbol on the product is in accordance with the European Union's Waste Electrical and Electronic Equipment (WEEE) Directive. The symbol indicates that this product must be recycled/disposed of separately from other household waste. It is the end user's responsibility to dispose of this product by taking it to a designated WEEE collection facility for the proper collection and recycling of the waste equipment. The separate collection and recycling of waste equipment will help to conserve natural resources and protect human health and the environment. For more information about recycling, please contact your local environmental office, an electrical/electronic waste disposal company or distributor where you purchased the product.

### 1.10.2 EU Directive RoHS

RoHS conformity is declared in the EU-conformity in Section 1.11.

## 1.11 Regulatory Statement

### EG-Konformitätserklärung EC Declaration of Conformity

Wir / We

**ibidi GmbH**  
**Lochhamer Schlag 11**  
**D-82166 Gräfelfing**

erklären hiermit die Übereinstimmung des genannten Produktes mit der Richtlinie 2014/35/EU - Niederspannungsrichtlinie und mit der Richtlinie 2014/30/EU über die Elektromagnetische Verträglichkeit.  
Bei Änderungen am Produkt, die nicht von uns autorisiert wurden, verliert diese Erklärung ihre Gültigkeit.

We declare the compliance of the product with the requirements of the Directive 2014/35/EU - Low Voltage Directive and with the Directive 2014/30/EU about the Electromagnetic Compatibility.  
Any modification to the product, not authorized by us, will invalidate this declaration.

Laborgerät / laboratory equipment:

#### **ibidi Temperature Controller ibiTC2-XXX with ibidi accessories**

Der oben beschriebene Gegenstand erfüllt die Vorschriften der Richtlinie 2011/65/EU vom 08. Juni 2011 zur Beschränkung der Verwendung bestimmter gefährlicher Stoffe in Elektro- und Elektronikgeräten.

The object of the declaration described above is in conformity with Directive 2011/65/EU of 8 June 2011 on the restriction of the use of certain hazardous substances in electrical and electronic equipment.

Das Produkt entspricht den unten aufgeführten Normen:  
The product meets the requirements of the following standards:

#### **DIN EN 61010-1:2011**

Sicherheitsbestimmungen für elektrische Mess-, Steuer-, Regel- und Laborgeräte - Teil 1: Allgemeine Anforderungen Safety requirements for electrical equipment for measurement, control and laboratory use - Part 1: General requirements

#### **DIN EN 61326-1:2013**

Elektrische Mess-, Steuer-, Regel und Laborgeräte. EMV-Anforderungen. Allgemeine Anforderungen  
Electrical equipment for measurement, control and laboratory use. EMC requirements. General requirements

Das Produkt ist gekennzeichnet mit/ The product is marked with



Gräfelfing, den 27.06.2019  
Gräfelfing, 2019-06-27

Ort/Datum  
Place/date

Dr. Valentin Kahl  
Geschäftsführer

Name, Funktion  
Name, Function



Unterschrift  
Signature

Diese Erklärung bescheinigt die Übereinstimmung mit den genannten Richtlinien, ist jedoch keine Zusicherung von Eigenschaften. Die Sicherheitshinweise der Produktdokumentation sind zu beachten.

This declaration certifies the conformity to the specified directives but not includes any warranted quality of the instrument. The safety documentation of the product shall be considered in detail



## 2 Intended Use

The ibidi Heating System, Universal Fit is a stage top incubator for live cell imaging that fits onto inverted microscope stages with a universal mounting frame for multiwell plates. The geometry of the chamber, with a heated glass plate above the sample, provides a platform for keeping microscopy slides and dishes at a constant temperature during an experiment on a microscope.

For full control of the incubation environment, the ibidi Heating System, Universal Fit can be combined with the ibidi Gas Incubation System to regulate the CO<sub>2</sub> and O<sub>2</sub> concentrations as well as the humidity.

The design of the ibidi Heating System, Universal Fit, for 4  $\mu$ -Slides offers four positions to insert microscopy slides (75 × 25 mm).

## 3 Principle

### Physiological Conditions in Live Cell Imaging

The Heated Lid and Heated Plate are designed to keep cells on-stage at 37°C in microscopy slides and dishes (Figure 1). To achieve this, the glass top of the Heated Lid and the Heated Plate are actively heated by the Temperature Controller. The Heated Lid prevents condensation effects inside the incubation system (Figure 2).

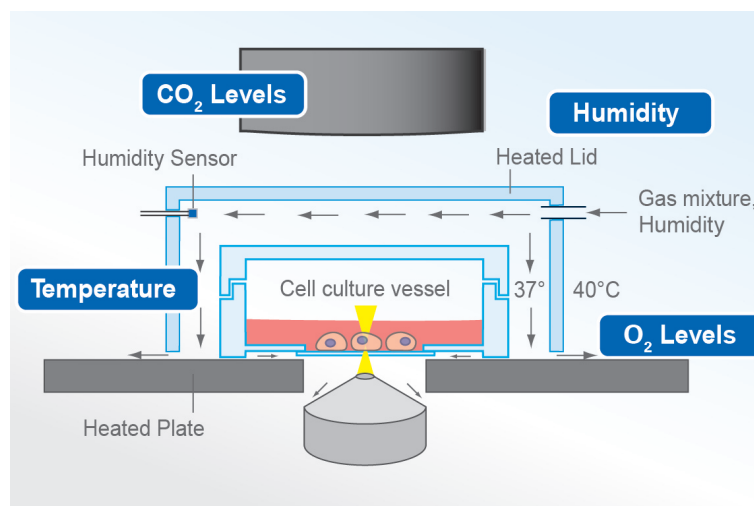

Figure 1 – Schematic cross-sectional view of the ibidi Heating System, Universal Fit.

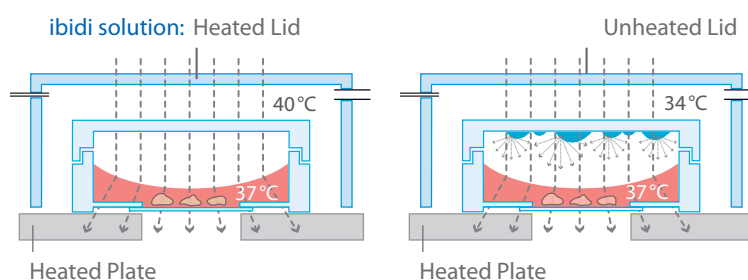

Figure 2 – The Heated Lid prevents condensation effects on the lid of the cell culture vessel.

## 4 Equipment

This section provides a brief overview over all parts of the ibidi Heating System, Universal Fit including a description of the characteristics.

### 4.1 Components of the ibidi Heating System, Universal Fit, Universal Fit, for 4 $\mu$ -Slides

The components of the ibidi Heating System, Universal Fit are listed below.

Table 2 – Overview of the ibidi Heating System, Universal Fit’s components





Description	Drawing
Temperature Controller	
Heated Lid, Universal Fit with electrical cable and D-sub connector to connect to the Temperature Controller	
Heated Plate, Universal Fit, for 4 $\mu$ -Slides with electrical cable and D-sub connector to connect to the Temperature Controller	
Magnetic Holder to press samples tight onto the Heated Plate	
Temperature Adjustment Set: 1 temperature sensor 1 perforated ibidi $\mu$ -Slide 4 Well	
USB cable to connect the Temperature Controller with a computer	

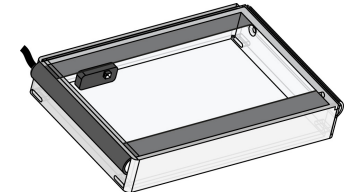
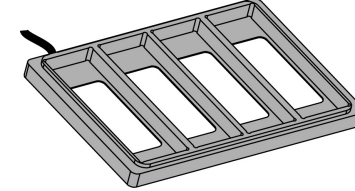
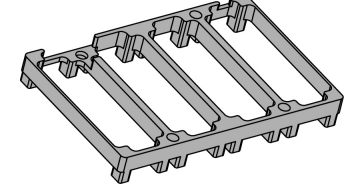
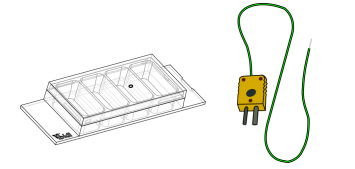

Table 2 – (continued)

Description	Drawing
Country specific power cord to connect the external power supply to the wall socket	
External power supply for the Temperature Controller	
USB flash drive with IncuControl software	

## 4.2 Combination Options

The parts of the ibidi Heating System, Universal Fit, are combined as shown in Figure 3. The Heated Lid and Heated Plate fit on an inverted microscope stage equipped with a universal mounting frame for multiwell plates. Heated Lid and Heated Plate are connected to the Temperature Controller.

There are two versions of the Heated Plate: one for insertion of one culture vessel and the other for insertion of four  $\mu$ -Slides.

To hold several geometries of Slides and Dishes, the Heated Plate for 1 Chamber can be equipped with different Inserts : Insert for  $\mu$ -Dish <sup>35 mm, high</sup>, Insert for  $\mu$ -Dish <sup>35 mm, low</sup>, Insert for  $\mu$ -Slides, and Insert for LabTek™ chambered coverglass.

For parallelization of experiments, the Heated Plate for 4  $\mu$ -Slides provides a platform to observe 4 Slides in parallel.

The ibidi Heating System, Universal Fit, can be combined with the Gas Mixer unit that provides CO<sub>2</sub> and O<sub>2</sub> (optional) control and a defined humidified atmosphere. Detailed information on the Gas Mixer unit is given in the Gas Mixer instructions.

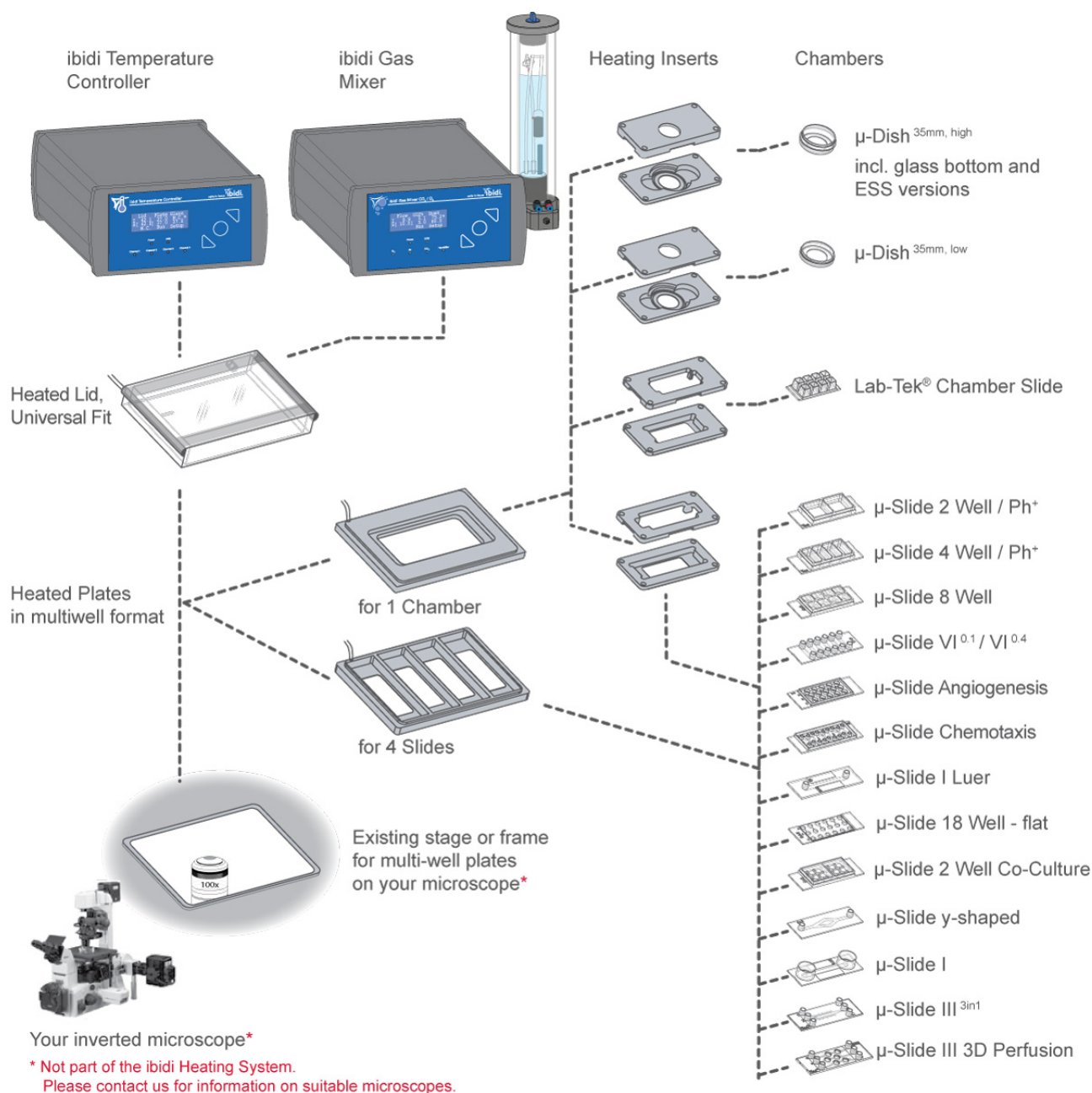

Figure 3 – Overview of the parts of the ibidi Heating System, Universal Fit, with options to combine

### 4.3 Temperature Controller

The Temperature Controller is designed to control the different heated components (four channels available).

The front display shows the set values (S) and the current values (I). The settings can be adjusted via the control buttons (Section 5.3).

If you wish to control the Temperature Controller via PC, use the IncuControl software (Section 6).

The LEDs on the front indicate the status of the channels, connection to the power supply, and USB connection (Figure 4).

Control LEDs Channel 1-4	
LED off	Channel inactive
LED on	Channel active
LED fast blinking	Channel error

All plugs for the electrical connections are integrated into the rear of the Temperature Controller (Figure 5). The setup of the connections is explained in Section 5.1.

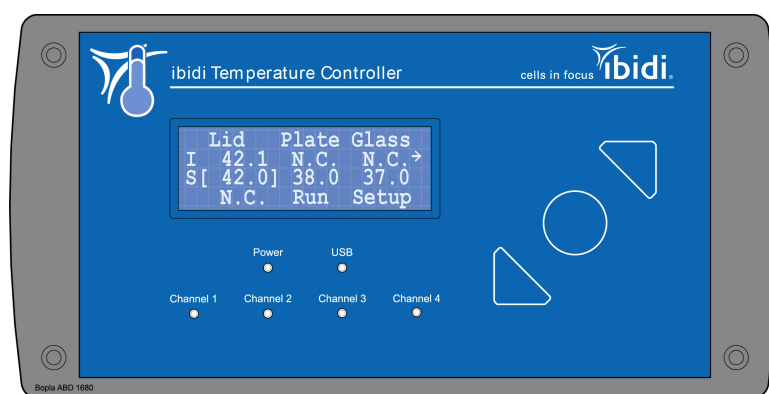

Figure 4 – Front view of the Temperature Controller.

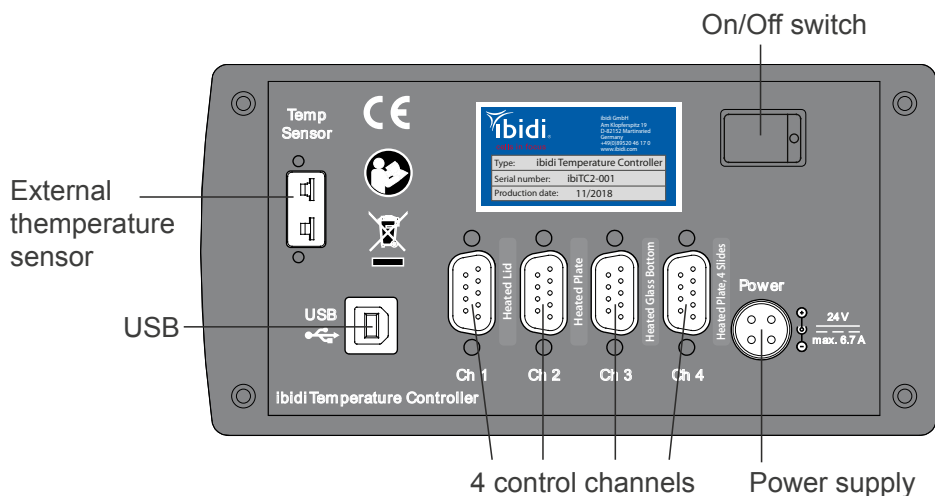

Figure 5 – Rear view of the Temperature Controller.

#### 4.4 Heated Lid

The Heated Lid provides excellent optical quality, and also allows for the use of all standard microscopy techniques, including differential interference contrast (DIC). Due to the height of the lid, we recommend using condensers with a working distance of  $\geq 26$  mm.

The upper glass part of the Heated Lid is heated. The electrical cable is connected to the Temperature Controller. The Heated Lid fits exactly and securely onto the Heated Plate.

For gas incubation, the Heated Lid is equipped with inlets for the gas flow and the humidity sensor. Detailed information on the Gas Incubation System is given in its [instruction manual](#).

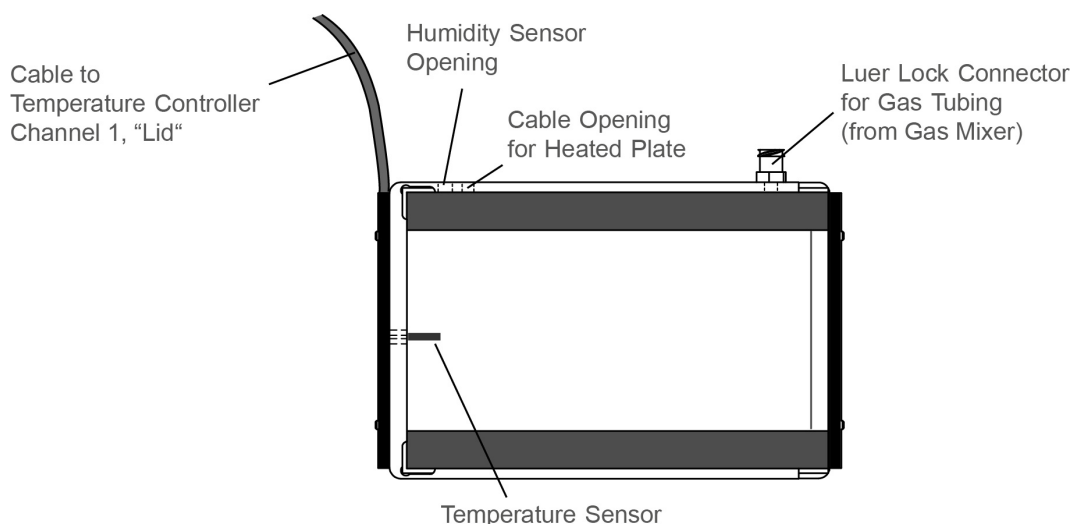

Figure 6 – Heated Lid

#### 4.5 Heated Plate and Magnetic Holder

The Heated Plate provides the base for the ibidi Heating System, Universal Fit. It fits into any microscope stage with a universal mounting frame for multiwell plates. The Heated Plate offers four cavities to mount  $\mu$ -Slides for parallel observation on the microscope. To prevent shifting of the samples, put the magnetic holder on top of the  $\mu$ -Slides. The electrical cable (1.5 m) is connected to the Temperature Controller.

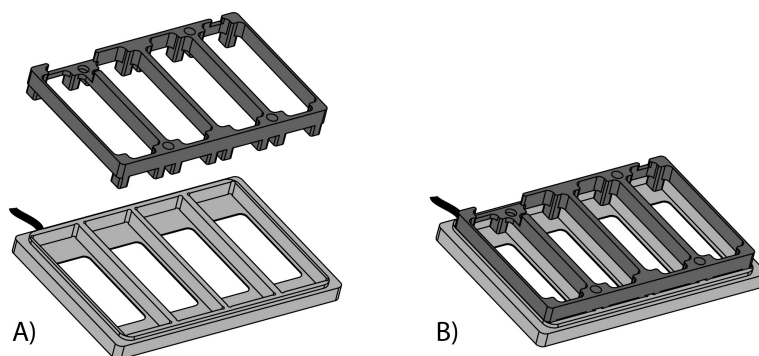

Figure 7 – Heated Plate for 4  $\mu$ -Slides (lower part) and magnetic holder (upper part) (A) and assembled (B).

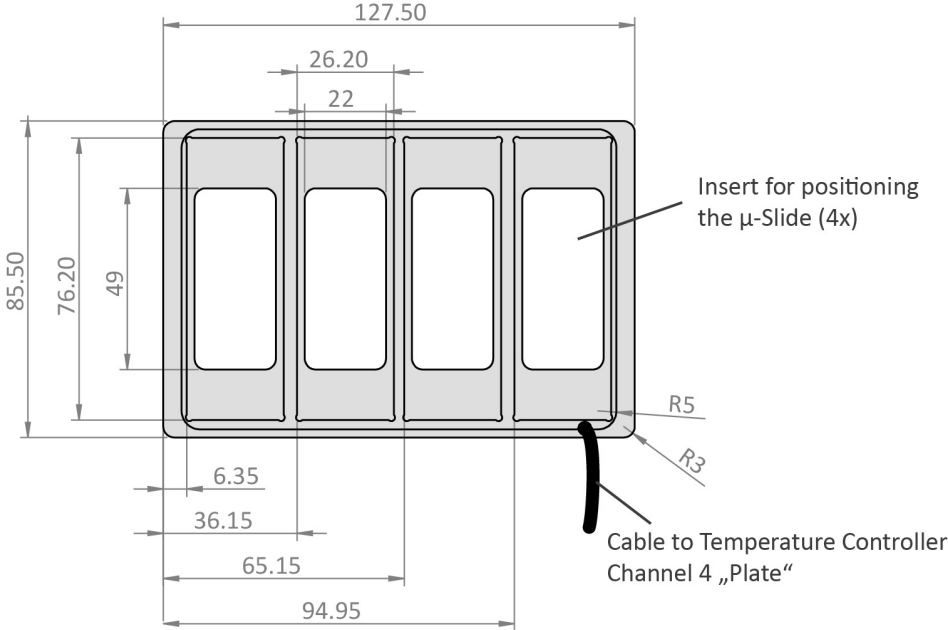

Figure 8 – Heated Plate for 4  $\mu$ -Slides, top view

## 5 Operation

Before starting an experiment, check that the ibidi Heating System, Universal Fit fits on your microscope stage, and that your cell culture vessels are compatible with the inserts of the Heated Plate. Connect all parts (Section 5.1) and perform a temperature adjustment as explained in Section 5.4.

### NOTE

The Temperature Controller only measures the temperature from the sensors in the Heated Lid and Heated Plate. The temperature in the sample must be adjusted for your specific setup. Follow the instructions in Section 5.4.

### 5.1 Installation and Connection of the Parts

The components of the ibidi Heating System, Universal Fit are connected as shown in Figure 9.

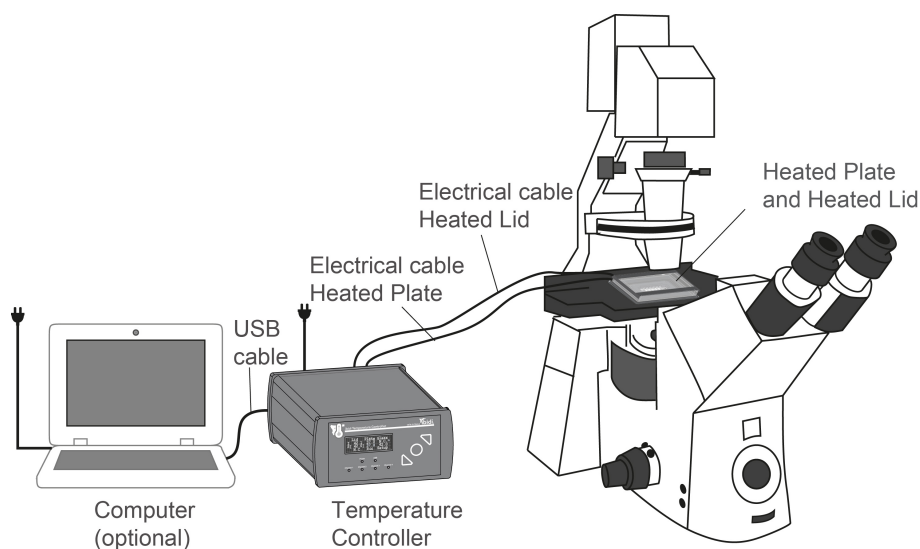

Figure 9 – Installation of the components of the ibidi Heating System, Universal Fit.

### NOTE

Before shipment, all controllers are run through an in-house calibration with the corresponding Heated Lid and Heated Plate. Only use the Temperature Controller with the corresponding Heated Lid and Heated Plate to ensure correct sensor calibration.

1. Place the Temperature Controller next to the microscope and connect the power supply.
2. Confirm that the power switch of the Temperature Controller is off.

3. Insert the Heated Plate into the opening of the microscope stage.
4. Insert four empty, unsterile  $\mu$ -Slides into the four inserts of the Heated Plate.
5. Place the magnetic holder onto the  $\mu$ -Slides and the Heated Lid onto the Heated Plate.
6. Plug the electrical cables of the Heated Lid (Channel 1) and Heated Plate for 4  $\mu$ -Slides (Channel 4) into the connectors on the back of the Temperature Controller. Let the system equilibrate for at least 30 minutes.

To setup communication with the IncuControl Software, the USB cable must be connected to the Temperature Controller and the computer.

To adjust the sample temperature, use the temperature sensor in the Temperature Adjustment Set and plug it into the corresponding connector on the back of the Temperature Controller. The other end is placed in the sample (Section 5.4).

## 5.2 Start the ibidi Heating System, Universal Fit

The Temperature Controller is switched on by the dip-switch on the back. Make sure the display shows "RUN" (see Section 5.3.1). The system immediately starts heating up the heated components.

### WARNING!

Be aware that when the system is switched on, 10V DC voltage is applied to the underside of the glass plate. Do not touch the underside or contact it with anything conductive! This could cause a short circuit that may destroy the controller and/or the lid.

If you are not sure which temperature is set (e.g. when operating the system the first time), it is recommended to disconnect all heated devices (Heated Plate, Heated Lid, and other optional heated devices) and then switch the system on. By doing this, you ensure that you do not start the heating process with the wrong temperature settings. It is now possible to set the temperatures for the individual channels (Section 5.3). After this, you can re-connect the heated devices.

## 5.3 Setting Parameters in the Front Display

All control parameters can be manually set on the controller using the buttons and the display on the front panel.

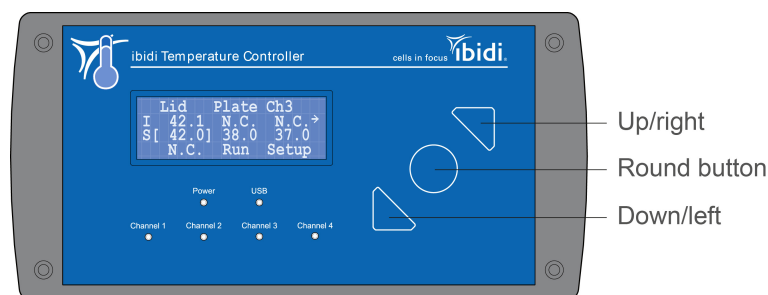

Figure 10 – Temperature Controller front display and set buttons.

The display shows the measured ('I' = instantaneous) and set ('S' = set) temperatures of all the channels. Only three channels are visible in the display at once. To see the further channel(s), move the cursor to the right/left and the display will jump to show the next channel.

The cursor position is indicated with square brackets (" [ ] "). You can move the cursor using the "left" and "right" buttons. If you want to select a parameter or a function, press the round button and the square brackets will change to angle brackets (" < > "). Now you are able to change the value with the "up" and "down" buttons. To confirm the changed value, you must press the round button once more.

Standardly, the channels are pre-defined with the following settings to match all possible combinations of heated components on the controller:

Table 4 – Channel assignment of the Temperature Controller

Channel No.	Short name	Components to connect	Product number
Channel 1	"Lid"	Heated Lid, Universal Fit or Heated Lid, Multi-Well Plates, K-Frame	#10918, #10927 #10929
Channel 2	"Plate"	Heated Plate, Universal Fit, for 1 Chamber or Heated Plate, Multi-Well Plates, K-Frame	#10918 #10929
Channel 3	"Glass"	Heated Glass Bottom, Multi-Well Plates, K-Frame	#10929
Channel 4	"Ch4"	Heated Plate, Universal Fit, for 4 $\mu$ -Slides	#10927, #10928

### 5.3.1 Run/Stop Mode

Set the whole system to run or stop mode by manipulating the setting in the display's bottom line to "Run" (= system is running) or "Stop" (= system is not running).

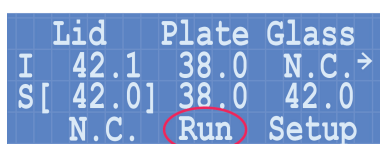

Figure 11 – Main display indicating "Run"

### 5.3.2 Incubation Parameters

Set the parameters in the front display and wait for the temperature to equilibrate. It is recommended to start the system at least 30 minutes before inserting cells. Recommended values are given in table 5.

Before starting an experiment, an initial temperature adjustment must be performed (see Section 5.4).

### 5.3.3 Setup Menu

The Setup menu offers the possibility to change the settings of the individual channels and the display. For standard operation no changes need to be made. Enter the setup menu by navigating to the "Setup" entry and pressing the round button. The mode dialog will open.



**Mode** Each channel of the Temperature Controller can be set to an "On" or "Off" state. For standard operation all channels must be turned on.

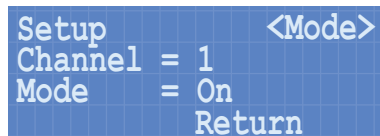

Figure 12 – Mode dialog

1. Press the round button once more to move the cursor to the channel number.
2. Select the respective channel and confirm with the round button.
3. Select "On" or "Off" and confirm with the round button.
4. To move on navigate to "Return" and press the round button.

**Alarms** In this dialog it is possible to set the alarm limits for divergent control parameters. Move from the mode menu to the alarm menu by pressing the "up/right" button.

The maximum and minimum limits of the alarm can be set for each individual channel. If the alarm is activated (which happens when the current value goes under/over the low/high limits), the current value (I) blinks, showing alternately the value and "low" or "high", respectively. To stop the display blinking, navigate to the blinking channel and press the round button once.

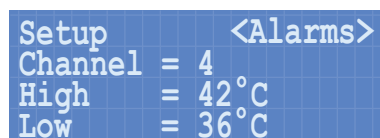

Figure 13 – Alarm settings dialog

**Preferences** Set the brightness and contrast of the display in the preferences menu.

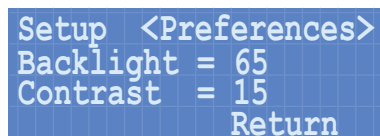

Figure 14 – Preferences dialog

**Info** Info about serial number and firmware version is shown in the info dialog.

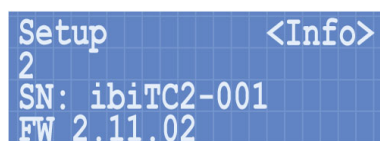

Figure 15 – Info display

## 5.4 Temperature Adjustment in the Sample

The ibidi Heating System, Universal Fit controls the temperature of the actively heated components (Heated Lid and Heated Plate). The temperature in the sample results from the interaction of all heated parts with the supporting microscopy stage and the sample. Therefore, the temperature at the position of the cells must be measured and adjusted for each specific setup to achieve the optimal temperature (e.g. 37°C).

When starting the temperature adjustment in the sample in your specific setup, use the recommended temperature settings (for samples that should be 37°C):

Table 5 – Recommended temperature settings before optimization

Device	Temperature
Heated Lid (channel 1)	42°C
Heated Plate (channel 4)	38°C

To measure and calibrate the sample temperature, use the provided Temperature Adjustment Set (temperature sensor and culture vessel with perforated lid). The temperature of the heated components has to be adjusted in small steps. Follow this procedure to adjust the sample temperature:

1. Set all your peripheral experimental parameters, such as room temperature, air conditioning, airflow, illumination, microscope settings, etc.
2. Connect the temperature sensor (thermocouple type K) to the plug on the Temperature Controller's back.
3. Fill the provided culture vessel (depending on what you want to use for your experiments) with water or medium. Volumes should be the same amount you need for your experiments.
4. Put the loose end of the thermocouple through the hole in the lid of the culture vessel and make sure it dips into the liquid. In case of a channel slide (e.g.  $\mu$ -Slide Luer) introduce the sensor wire from the Luer ports into the channel.
5. Place the culture vessel in the insert of the Heated Plate and put the magnetic holder on.
6. Close the Heated Lid.
7. After 30 minutes, check the temperature of the external sensor on the display or in the Incu-Control software. If the sample temperature is still too low, raise the set values for the Heated Plate and Heated Lid for 0.5–1°C and wait until the sample temperature is stable again (at least 10–15 min).
8. When the sample temperature has reached the desired value, write down the set values for the Heated Plate and Heated Lid and use those settings for all upcoming experiments with the same probe holder.

**NOTE**

The temperature of the Heated Lid must be set to at least some degrees warmer than the temperature of the Heated Plate!

The temperature adjustment must be repeated from time to time (at least once a year), especially if one of the following conditions has been changed:

- Room temperature
- Air conditioning
- Chamber type or objective lens
- Humidification and gas flow
- Use of an XL-Incubator
- Use of an Objective Heater

## 5.5 Sample Preparation

Check that the cell cultureware you intend to use fits into the insert of the ibidi Heating System, Universal Fit's Heated Plate.

Prepare the cells according to your protocol and place the  $\mu$ -Slide in the Heated Plate. Then put the magnetic holder onto the Heated Plate and close the Heated Lid.

**NOTE**

Let the temperature of the system equilibrate for a minimum of 30 min before you start your experiments. Always use unsterile dummy slides in all 4 slots during equilibration.

## 6 IncuControl Software

The Temperature Controller has a USB interface for computer control and data logging. For this purpose, ibidi provides the IncuControl software that comes with the controller or can be downloaded from the [ibidi website](#).

For more details, please refer to the [IncuControl instructions](#).

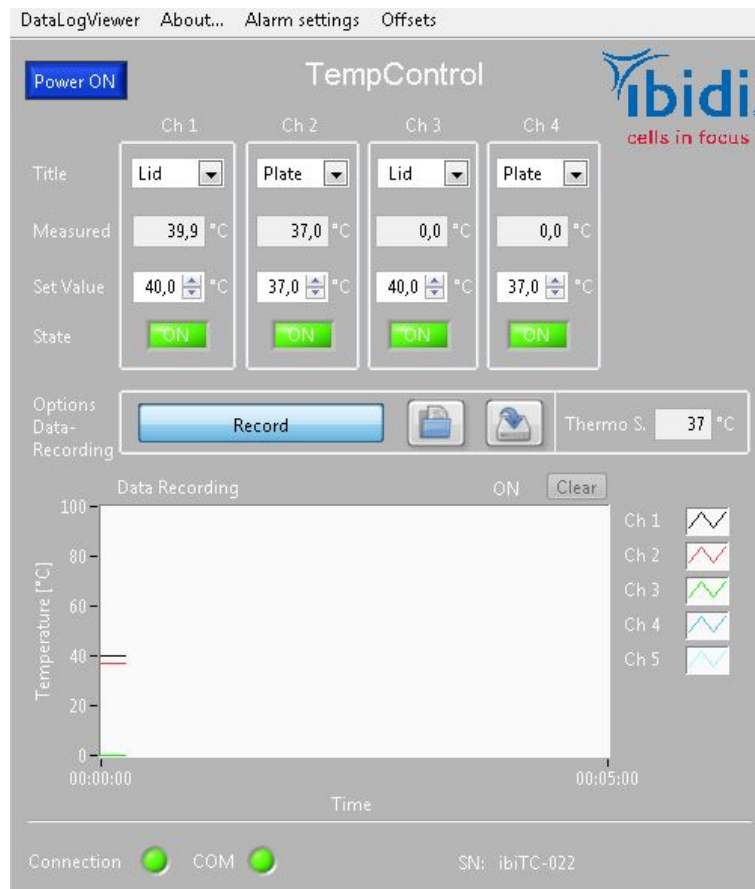

Figure 16 – Temperature control window in IncuControl.

## Prohibitions on the use of ibidi software:

The following actions are prohibited:

- Copying software for other than backup purposes
- Transferring or licensing of the right to use software to a third party
- Disclosure of confidential information regarding software
- Modification of software

## 7 Maintenance

### 7.1 Disinfection and Cleaning

The heated components and the Temperature Controller do not have to be sterile, because the incubation chamber has no direct contact with the cells and the cell culture medium. If disinfection is necessary for some reason, we recommend using isopropanol (70%) or common lab disinfection solutions based on quaternary ammonium compounds (e.g. Barrycidal 36 or Pharmacidal).

All parts of the ibidi Heating System, Universal Fit can be cleaned from the outside. We recommend using ultrapure water for cleaning. Fingerprints on the Heated Lid can be removed using isopropanol (70%) or lens/eyeglass cleaning wipes.

### CAUTION

When cleaning the heated glass plate(s), be careful when wiping the inner surface of the lid not to damage the electro-conductive coating. Also take care not to damage the glass plate. The use of ethanol or other types of organic solvents may remove the instrument's paint.

To clean the heated components and/or the Temperature Controller switch off the Temperature Controller and disconnect all electrical cables. Leave the instrument to cool down for approx. 5 minutes.

### WARNING!

Hot surface (max. 55°C)! Do not touch Heated Lid, Heated Plate, and Heated Glass Bottom when hot.

## 7.2 Influence of Ambient Temperature and Ventilation

The ambient temperature affects the conditions inside the incubation chamber. Devices, such as computers and camera controllers, can significantly heat up small rooms. In this case, we recommend equilibrating the room temperature to the typical experimental conditions at least 2-3 hours before starting the experiment.

Ventilation can enhance the effect of temperature and humidity changes in the vicinity of the incubation chamber. In a case where the airflow (e.g., air conditioning) cannot be stopped, we recommend protecting the microscope as much as possible.

The use of an XL-Incubator and/or an objective heater minimizes those effects and helps significantly to stabilize surrounding conditions.

## 8 Troubleshooting

### 8.1 Focus not Stable

Focus drift is detrimental for most microscopy experiments, especially long duration time-lapse experiments. Focus stability is mainly influenced by mechanical changes and temperature variations. Follow these recommendations to keep your cells in focus:

- Switch on all components (e.g., heating, gas incubation, computer, or other equipment) at least 60 minutes before starting the experiment.

- After you put the sample onto the microscope, wait 30 minutes before starting a time-lapse experiment to achieve temperature and immersion oil equilibration<sup>1</sup>.
- Keep the room temperature as stable as possible. Air conditioning should either be working continuously or switched off.
- Do not change the temperature during the experiments. Avoid door/window openings, as this could rapidly change the temperature.
- Eliminate all sources of mechanical vibrations. Use a damped table for your microscope.

## 8.2 Evaporation Is Too High

Depending on the incubating conditions, small volumes might evaporate quickly, especially during long-term experiments. If you have an actively controlled humidifying device (e.g. ibidi Gas Incubation System), increase the set value for relative humidity. Additionally, we suggest using silicone oil (e.g. Anti-Evaporation Oil, ibidi, 50051) to decrease evaporation.

Covering the medium with sterile silicone oil prevents all evaporation effects and is compatible with cell culture. Please do not use mineral oil, as this can be harmful to your cultureware.

Equilibrate oil and medium inside the incubator overnight. This step helps to avoid the formation of air bubbles, and pre-warms the solutions to 37°C. Afterwards, fill your slide with cells and medium. Cover the medium's surface with an appropriate amount of silicone oil. Don't drip the oil directly onto the surface, but let it run down the edges of the cell culture vessel. Details about avoiding evaporation are given on the ibidi web site in [Application Note 12 "Avoiding Evaporation"](#).

## 8.3 Condensation Inside the Stage Top Incubator

Check the temperature of the chamber (Heated Lid and Heated Plate). Make sure the humidity sensor is not in contact with the Heated Lid. In case of condensation, decrease the humidity and air-dry the incubator if necessary.

Please contact ibidi at [techsupport@ibidi.com](mailto:techsupport@ibidi.com) for further troubleshooting help.

---

<sup>1</sup>If the experiment needs to be started immediately, either after placing the sample on the microscope or after closing the lid, we recommend checking the focus for 20 minutes. In the first few minutes after starting the experiment, temperature equilibration might influence the focus/z-position of the cells.





ibidi GmbH

Lochhamer Schlag 11  
82166 Gräfelfing  
Germany

Toll free within Germany:  
Phone: 0800 / 00 11 11 28  
Fax: 0800 / 00 11 11 29

International calls:  
Phone: +49 89 / 520 46 17 - 0  
Fax: +49 89 / 520 46 17 - 59

E-Mail: [info@ibidi.com](mailto:info@ibidi.com)  
[www.ibidi.com](http://www.ibidi.com)

