



### ► Company Overview

Biologix Group Limited is committed to the design and manufacture of high quality, reasonably-priced scientific and biomedical supplies. Throughout its long company history, Biologix has excelled at providing top quality laboratory supplies to distributors at unbeatable prices.

Biologix has been continuously offering not only the traditional regular lab consumables in the field of molecular biology, histology, microbiology etc, but also the very popular Biobank products which is truly the current prevailing trends in the near future.

Biologix most products manufactured in our FDA and ISO certified facilities are certified sterile, DNase and RNase free and non-pyrogenic using the highest quality medical-grade plastic materials. Some of the world's top laboratory supplies, in vitro diagnostic kits, and medical devices are also produced by Biologix as OEM and/or Private Labeled products.

Biologix Group Limited strives to provide our customers with exactly what they are looking for by engaging in market research and participating in continuous new product development. Your products needs and demands are important to us. Our focus is on building long-term relationships, allowing us to have a better understanding of the knowledge and experience your need to be successful in your market.

We have developed a focus on meticulous control and constant improvement and innovation, as well as setting standards of excellence in our industry. We are proud to serve thousands of laboratories, as well as hundreds of distributors, all around the world.

### Contact Information

**Biologix Group Limited**  
Phone: +86-531-67802668

[Inquiry@BiologixGroup.com](mailto:Inquiry@BiologixGroup.com)  
[www.BiologixGroup.com](http://www.BiologixGroup.com)  
[www.CryoKING.com](http://www.CryoKING.com)

**Biologix Corporation**  
No.2766 Ying Xiu Road  
High-Tech Industrial Development Zone  
Jinan, Shandong 250101  
P.R. China

**Biologix USA, Inc.**  
10555 86th Ave.  
Pleasant Prairie, WI 53158 , USA  
Phone: +1-888-3233585. 816  
+1-816-6597165

**Biologix Europe GmbH**  
Mathias-Brüggen-Str 156,  
50829 Köln, Germany

# Ordering and Services

## Private Labeling

Biologix offers a Private Labeling Program, providing high quality, branded lab supplies at very competitive prices. Many Biologix products are currently private labeled and sold worldwide by some of the most prominent brands and distributors.

## OEM Services

Biologix also operates as an OEM provider for plastic laboratory consumables. With through our in-house molding and tooling capabilities, we can provide the exact products needed by our customers at significantly lower costs than other companies can achieve. Biologix currently supplies some of the world's top distributors with its OEM products.



## Ordering Information

### A. Free Product Samples

Let us send you a FREE sample package of our great products. Contact us today if you are interested in trying out Biologix products before you buy.

### B. Returned Products

Any return request must be authorized before credit is provided. Please provide the product, invoice number, and reason for return. A restocking fee may apply. Products returned 30 days after delivery and special order/custom products are subject to review prior to issuing credit.

### C. Distribution

If interested in distribution opportunities, please contact us for distributor terms and pricing. We are accepting distribution opportunities worldwide. Please contact us at [Inquiry@BiologixGroup.com](mailto:Inquiry@BiologixGroup.com).

Guaranteed Quality

Exceptional Service

Professional Design

Logical Pricing

## Certifications



CE



ISO

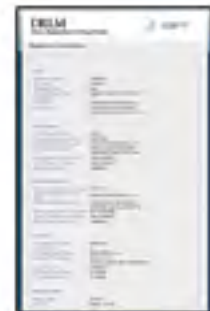

FDA

# Contents

## ► General Laboratory Supplies

---

Centrifuge Tubes.....	07
Microcentrifuge Tubes.....	08
Centrifuge Tube Racks.....	09
Pipet Tips.....	10
Filter Tips.....	11
Transfer Pipets.....	17
Solution Basins.....	18
Beakers.....	19
Reagent Bottles.....	20
Test Tubes.....	21
Slide Storage Boxes.....	22
Deep Well Plates.....	23
Gloves.....	24

## ► Cryogenic Series

---

Screw Cap Microtubes.....	26
Cryogenic Vials.....	27
Traditional Cryogenic Vials.....	28
CryoKING Cryogenic Vials.....	29
CryoKING Combo.....	30
Automated Product Series of SBS Standards.....	31
Premium Cardboard Cryogenic Boxes .....	32
ID-Color™ Cardboard Cryogenic Boxes .....	33
PC Cryogenic Boxes.....	34
PP Cryogenic Boxes.....	35
Freezer Racks.....	36,37,38,39
Scanners.....	40
Biobanking Management Software..	41
Ultra-low Temperature Freezers .....	42,43,44
Ultra-low Temperature Liquid Nitrogen Tanks.....	45,46,47

## ► Cell Culture Series

---

Cell Culture Flasks.....	49
Cell Culture Dishes.....	50
Cell Culture Plates.....	51
Serological Pipettes.....	52
Cell Culture Slides.....	53
Cell Strainers.....	54
Cell Scrapers & Lifters.....	55

## ► PCR

---

PCR Tubes.....	57
8-Strip PCR Tubes.....	58
PCR Plates.....	59,60

## ► Microbiology

---

Petri Dishes.....	62
Inoculating Loops & Needles.....	63
Cell Spreaders.....	64

## ► Drosophila

---

Drosophila Vials.....	66
Drosophila Bottles.....	67
Drosophila Plugs.....	68

## ► Instruments

---

Liquid Handling.....	70,71
Stirrers.....	72
Mixers & Rotators.....	73
Shakers.....	74,75
Thermocyclers.....	76
Centrifuges.....	77,78
Dry Bath Incubators.....	79,80
Electrophoresis.....	81
Transilluminators.....	82

# Catalog Number Index

Cat #	Page#	Cat #	Page#	Cat #	Page#	Cat #	Page#
01-1103	73	04-0250	20	10-0815	07	51-17721	67
01-1203	73	04-0500	20	10-0850	07	51-17725	68
01-1303	73	04-1005	20	10-9151	07	60-0002	57
01-2101	70	04-1010	20	10-9152	07	60-0008	58
01-2102	70	04-1015	20	10-9501	07	60-0056	59
01-2104	70	04-1030	20	10-9502	07	60-0082	57
01-2110	70	04-1060	20	10-9815	07	60-0088	58
01-2203	71	04-1125	20	10-9850	07	60-0102	57
01-2213	71	04-1200	20	12-1275	21	60-0108	58
01-2306	70	04-1250	20	12-1299	21	60-0156	59
01-2413	70	04-1500	20	12-1300	21	60-0182	57
01-2423	70	04-2008	20	12-1399	21	60-0188	58
01-2433	70	04-2015	20	12-2275	21	60-0202	57
01-2443	70	04-2030	20	15-1040	54	60-0208	58
01-2703	71	04-2060	20	15-1070	54	60-0256	59
01-2801	70	04-2100	20	15-1100	54	60-0282	57
01-2805	70	04-2125	20	20-0010	10	60-0288	58
01-2830	70	04-2250	20	20-0200	10	60-0302	57
01-3103	72	04-2500	20	20-1000	10	60-0308	58
01-3203	72	04-3008	20	20-1250	10	60-0356	59
01-3303	72	04-3015	20	21-0010	10	60-0382	57
01-6103	74	04-3030	20	21-0200	10	60-0388	58
01-6113	74	04-3060	20	21-1000	10	60-0402	57
01-6203	74	04-3100	20	21-1250	10	60-0408	58
01-6213	74	04-3125	20	22-0010	11	60-0456	59
01-6303	75	04-3250	20	22-0011	11	60-0482	57
01-6313	75	04-3500	20	22-0200	11	60-0488	58
01-6403	75	07-2101	53	22-0201	11	65-0001	63
01-6413	75	07-2102	53	22-1000	11	65-0002	63
01-7003	76	07-2104	53	22-1001	11	65-0010	63
01-7103	76	07-2108	53	23-0010	11	65-1001	64
01-8003	77	07-3035	50	23-0011	11	65-1010	64
01-8203	77	07-3060	50	23-0200	11	66-1501	62
01-8213	77	07-3100	50	23-0201	11	66-1515	62
01-8303	78	07-3150	50	23-1000	11	66-1560	62
01-8313	78	07-5001	52	25-0052	18	70-1180	55
01-9103	79	07-5002	52	25-0051	18	70-1250	55
01-9203	79	07-5005	52	25-1025	18	70-2180	55
01-9303	80	07-5010	52	25-1100	18	7101	22
02-1016	23	07-5025	52	25-1202	18	7105	22
02-1022	23	07-5050	52	30-0135	17	80-0015	08
02-2010	23	07-6006	51	30-0135A1	17	80-0500	08
03-1300	81	07-6012	51	30-0138	17	80-1500	08
03-2300	81	07-6024	51	30-0138A1	17	80-1501	08
03-3070	81	07-6048	51	30-0238A1	17	80-1502	08
03-3100	81	07-6096	51	41-5025	22	80-1503	08
03-4221	80	07-8025	49	41-5100	22	81-0000	26
03-4222	80	07-8075	49	41-6025	22	81-0001	26
03-6200	82	07-8175	49	41-6100	22	81-0002	26
04-0005	20	07-9025	49	51-0500	66	81-0003	26
04-0010	20	07-9075	49	51-0501	66	81-0004	26
04-0015	20	07-9175	49	51-0505	68	81-0005	26
04-0030	20	10-0151	07	51-0800	66	81-0006	26
04-0060	20	10-0152	07	51-0801	66	81-0053	26
04-0125	20	10-0501	07	51-0805	68	81-0054	26
04-0200	20	10-0502	07	51-17720	67	81-0055	26

# Catalog Number Index

Cat #	Page#	Cat #	Page#	Cat #	Page#	Cat #	Page#
81-0056	26	89-350X	30	96-2216	38	99-6206	37
81-0153	26	89-403X	31	96-2220	38	99-6207	37
81-0154	26	89-405X	31	96-2224	38	99-6208	37
81-0203	26	89-408X	31	96-2230	38	99-6209	37
81-0204	26	89-410X	31	96-5212	37	99-6210	37
81-7053	27	89-905X	30	96-5215	37	99-6211	37
81-7054	27	89-910X	30	96-5216	37	99-6212	37
81-7055	27	89-915X	30	96-5220	37	99-6213	37
81-7056	27	89-920X	30	96-6206	38	99-7124	36
81-7153	27	89-921X	30	96-6207	38	99-7128	36
81-7154	27	89-950X	30	96-6208	38	99-7132	36
81-7203	27	90-1200	32	96-6209	38	99-7216	36
81-7204	27	90-1281	32	96-6210	38	99-7220	36
81-7205	27	90-1536	09	96-6211	38	99-7224	36
81-8204	27	90-1550	09	96-6212	38	CKD-V035S013	45
88-005X	29	90-2200	32	96-6213	38	CKD-V045S013	45
88-010X	29	90-2281	32	96-7216	39	CKD-V055S013	45
88-015X	29	90-2300	32	96-7220	39	CKD-V075S013	45
88-105X	29	90-2381	32	96-7224	39	CKD-V085S013	45
88-020X	29	90-5016	09	96-7124	39	CKD-V100S013	45
88-021X	29	90-5025	09	96-7128	39	CKD-V130S013	45
88-050X	29	90-5200	32	96-7132	39	CKD-V160S013	45
88-105X	29	90-5281	32	97-1111	24	CKD-V180S013	45
88-110X	29	90-6281	33	97-1112	24	CKD-V180S014	45
88-115X	29	90-8009	09	97-1113	24	CKD-V190S014	45
88-120X	29	90-8100	33	97-1114	24	CKD-V200S014	45
88-121X	29	90-8200	33	97-1115	24	CKD-V210S014	45
88-150X	29	90-8281	33	97-6111	24	CKD-V220S014	45
88-320X	28	90-8381	33	97-6112	24	CKF-UL100	44
88-321X	28	90-9009	34	97-6113	24	CKF-UL290	44
88-350X	28	90-9025	35	97-6114	24	CKF-UL340	44
88-403X	31	90-9081	35	97-6115	24	CKF-UL508	43
88-405X	31	90-9100	35	98-0113	34	CKF-UL538	44
88-408X	31	90-9200	35	98-0213	34	CKF-UL540	43
88-410X	31	90-9210	34	98-0313	34	CKF-UL668	44
88-600X	28	90-9250	34	98-4117	31	CKF-UW138	44
88-605X	29	90-9381	34	98-4217	31	CKF-UW328	44
88-610X	29	93-0050	19	99-1124	36	CKF-UW438	44
88-615X	29	93-0100	19	99-1128	36	CKF-ZW128	42
88-620X	28	93-0250	19	99-1132	36	CKS-0101	40
88-621X	28	93-0400	19	99-1216	36	CKS-0201	40
88-650X	28	93-0800	19	99-1220	36	CKS-1101	40
88-720X	29	93-1000	19	99-1224	36	CKS-1201	40
88-721X	29	96-1124	39	99-2118	37	CKS-L010Q125	46
88-750X	29	96-1128	39	99-2120	37	CKS-L015Q125	46
88-905X	29	96-1132	39	99-2121	37	CKS-L020Q125	46
88-910X	29	96-1216	39	99-2124	37	CKS-L025Q125	46
88-915X	29	96-1220	39	99-2128	37	CKS-L030Q125	46
88-920X	29	96-1224	39	99-2132	37	CKS-L035Q125	46
88-921X	29	96-2118	38	99-2216	37	CKS-L047Q127	46
88-950X	29	96-2121	38	99-2220	37	CKS-L050Q125	46
89-305X	30	96-2120	38	99-2224	37	CKS-L065Q216	46
89-310X	30	96-2124	38	99-2230	37	CKS-L095Q216	46
89-315X	30	96-2128	38	99-5212	36	CKS-L115Q216	46
89-320X	30	96-2132	38	99-5215	36	CKS-L140Q216	46
89-321X	30	96-2212	38	99-5216	36	CKS-L175Q216	46
		96-2215	38	99-5220	36		

# General Laboratory Supplies

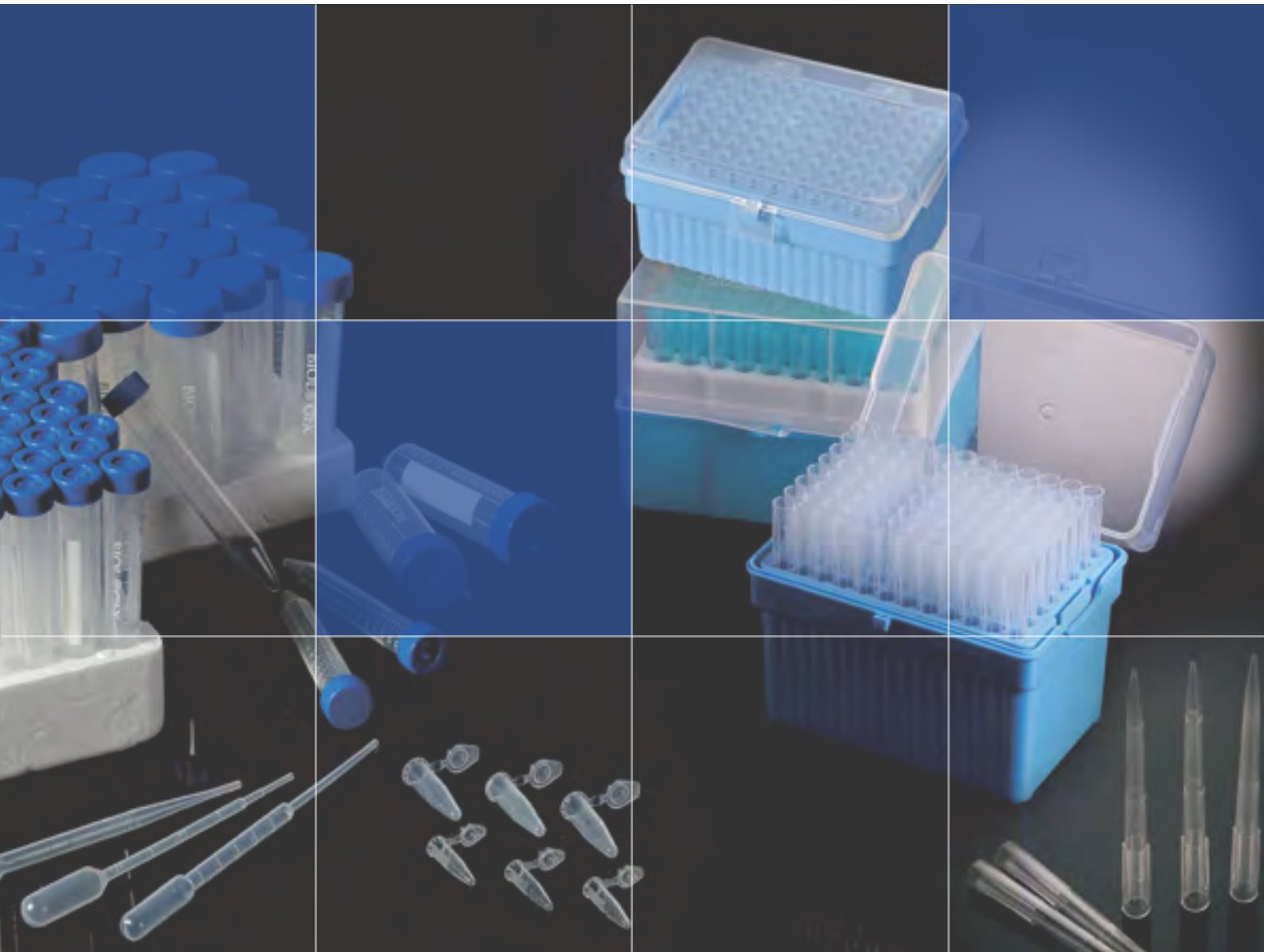

The General Laboratory Supplies section includes many consumables commonly used in basic laboratory and medical procedures. From centrifuge tubes and test tubes to disposable gloves and microscope slides, many of these general laboratory supplies may have applications in multiple life science fields.

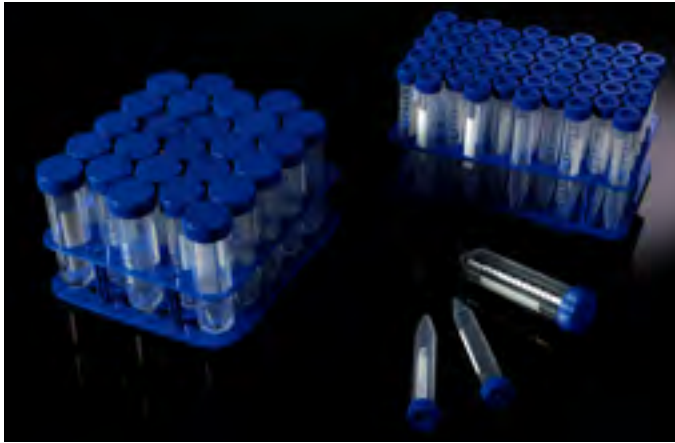

## Features

- Tubes: made of strong, highly transparent medical grade polypropylene
- Flat-top caps: made of medical grade polyethylene
- Plug-seal screw on caps: made of medical grade polypropylene
- 15ml and 50ml conical tubes available;
- Large white writing area for easy marking
- Double threaded design reduces cross-threading; caps are easily opened and closed
- Flat-top caps can be written on
- Gamma radiation sterilized, non-pyrogenic
- Available in racked package (sterile) or bulk package (sterile & non-sterile)

## Specifications

- Working temperature: stable from -20°C to 121°C (except flat-top cap)
- 15ml and 50ml tubes can withstand centrifugation of 8,400 and 9,400 RCF respectively
- Sealing test: complies with the International Air Transport Association (IATA) Safety Standards

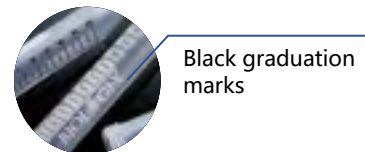
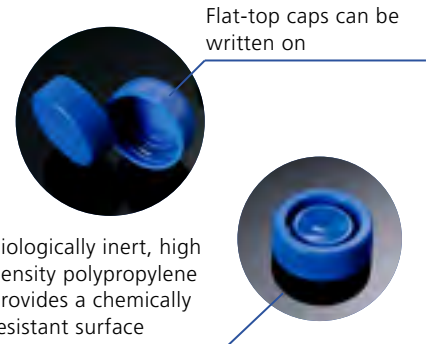

Cat #	Volume	Caps	Sterile	Package	Unit
10-9151	15ml	Flat Top	Yes	Rack	50 /Rack, 10 Racks /Case
10-9152	15ml	Flat Top	Yes	Bulk	25 /Bag, 20 Bags /Case
10-9501	50ml	Flat Top	Yes	Rack	25 /Rack, 20 Racks /Case
10-9502	50ml	Flat Top	Yes	Bulk	25 /Bag, 20 Bags /Case
10-9815	15ml	Flat Top	No	Bulk	500 /Case
10-9850	50ml	Flat Top	No	Bulk	500 /Case
10-0151	15ml	Plug Seal	Yes	Rack	50 /Rack, 10 Racks /Case
10-0152	15ml	Plug Seal	Yes	Bulk	25 /Bag, 20 Bags /Case
10-0501	50ml	Plug Seal	Yes	Rack	25 /Rack, 20 Racks /Case
10-0502	50ml	Plug Seal	Yes	Bulk	25 /Bag, 20 Bags /Case
10-0815	15ml	Plug Seal	No	Bulk	500 /Case
10-0850	50ml	Plug Seal	No	Bulk	500 /Case

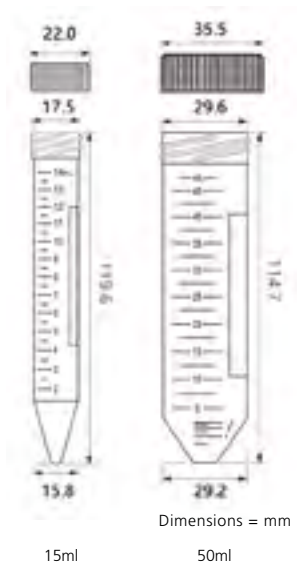

# Microcentrifuge Tubes



80-0500



80-0015



80-1500 (Clear)



## Features

- Made of high quality medical grade polypropylene
- Transparent tube walls permit easy viewing of contents
- Beveled lip for convenient one-handed operation
- Writing area and attached flat cap for labeling
- RNase & DNase free

## Specifications

- Working temperature: stable from -20°C to 121°C
- Can withstand high speed centrifugation of 20,000 RCF

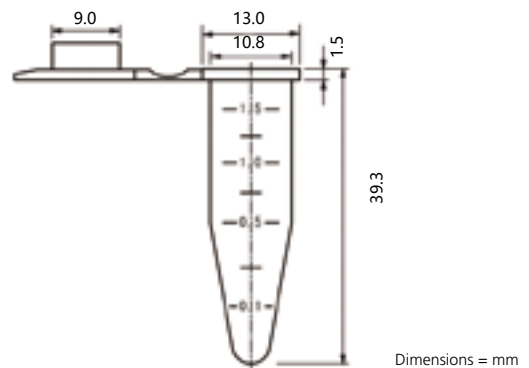

Cat #	Volume	Color	Sterile	Unit
80-0500	0.5ml	Clear	No	500 /Bag/Pack, 10 Packs/Case
80-0015	1.5ml	Clear	No	500 /Bag/Pack, 10 Packs/Case
80-1500	1.5ml	Clear	No	500 /Bag/Pack, 10 Packs/Case
80-1501*	1.5ml	Red	No	500 /Bag/Pack, 10 Packs/Case
80-1502*	1.5ml	Yellow	No	500 /Bag/Pack, 10 Packs/Case
80-1503*	1.5ml	Blue	No	500 /Bag/Pack, 10 Packs/Case

\* There is MOQ for these items



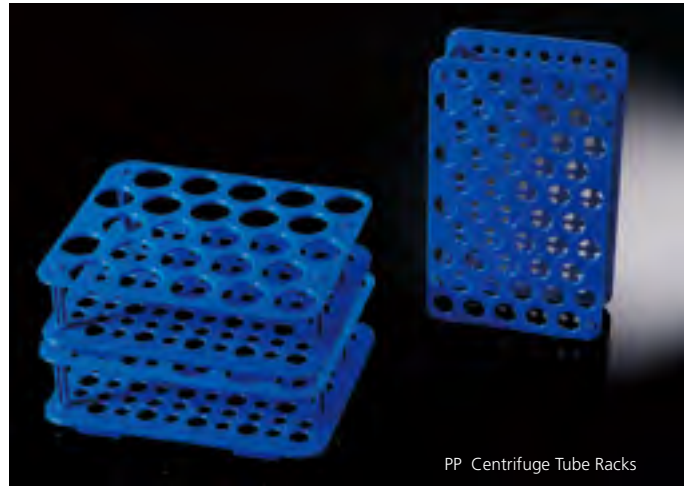
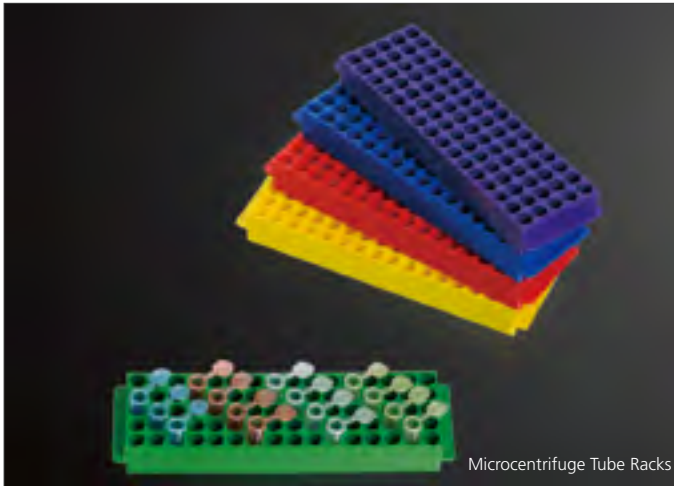

## Features

### Microcentrifuge Tube Racks

- Made of high strength plastic, chemically resistant to alcohols and mild organic solvents
- Writing area on side of rack for easy marking
- Handles on each end for secure handling
- 5x16 array, 80 wells, molded with a numeric grid for easy tube identification

### PP Centrifuge Tube Racks

- Made of high quality medical grade polypropylene
- 50-well racks hold 15ml centrifuge tubes
- 25-well racks hold 50ml centrifuge tubes
- Sturdy design keeps tubes upright

### Cardboard Centrifuge Tube Racks

- Made of durable cardboard with superior white coating, chemically resistant to alcohols and mild organic solvents
- 36-well racks for 15ml centrifuge tubes, 16-well racks for 50ml centrifuge tubes
- Removable lid features a lined writing area



Cardboard Centrifuge Tube Rack  
Working temperature:  
from -196 °C to 121 °C

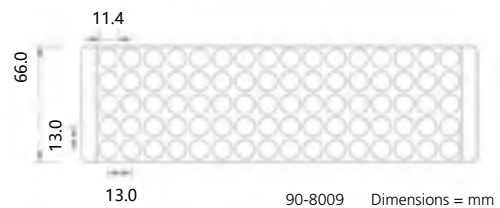
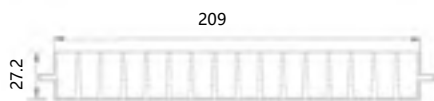

Cat #	Well	Color	Sterile	Unit
90-8009	80-well	Assorted Colors	No	5 /Bag, 4 Bags/Case
90-1536	36-well	White	No	5 /Bag, 20 Bags/Case
90-5016	16-well	White	No	5 /Bag, 20 Bags/Case
90-1550	50-well	Blue	No	1 /Bag, 20 Bags/Case
90-5025	25-well	Blue	No	1 /Bag, 20 Bags/Case

# Pipet Tips

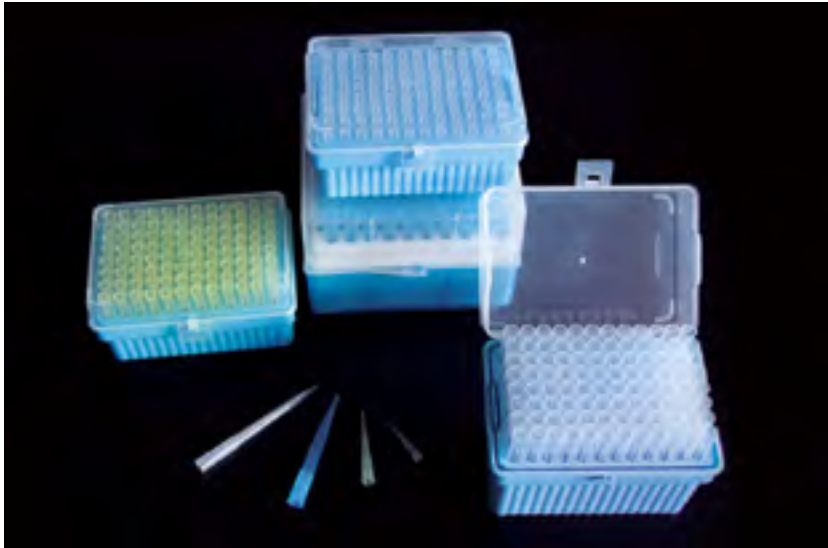

## Features

- Made of polypropylene, autoclavable
- Available in 10µl, 200µl and 1000µl sizes, suitable for standard manual and electronic pipettes
- 10µl and 200µl tips are graduated, 200µl tips have a beveled point design that reduces sample retention
- Extended 1000µl tips facilitate pipetting from deep or narrow containers
- RNase & DNase free, non-pyrogenic
- Available in racked package (sterile) and bulk package (non-sterile)

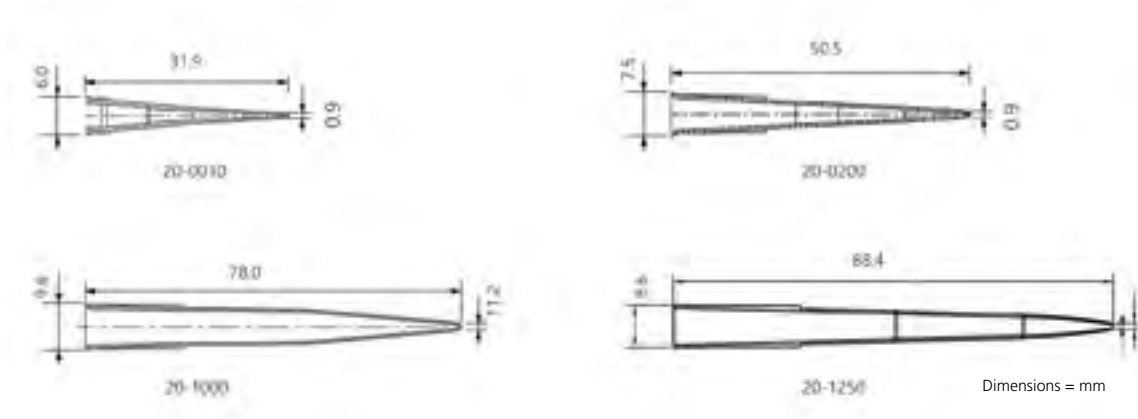

Cat #	Volume	Color	Sterile	Unit
20-0010	10µl	Natural	No	1,000 /Bag, 2 Bags /Pack, 5 Packs/Case
21-0010	10µl	Natural	Yes	96 /Rack, 10 Racks/Pack, 10 Packs/Case
20-0200	200µl	Yellow	No	1,000 /Bag/Pack, 10 Packs/Case
21-0200	200µl	Yellow	Yes	96 /Rack, 10 Racks/Pack, 10 Packs/Case
20-1000	1000µl	Blue	No	1,000 /Bag/Pack, 10 Packs/Case
21-1000	1000µl	Blue	Yes	100 /Rack, 6 Racks/Pack, 10 Packs/Case
20-1250	1000µl Extended	Natural	No	1,000 /Bag/Pack, 10 Packs/Case
21-1250	1000µl Extended	Natural	Yes	96 /Rack, 6 Racks/Pack, 10 Packs/Case

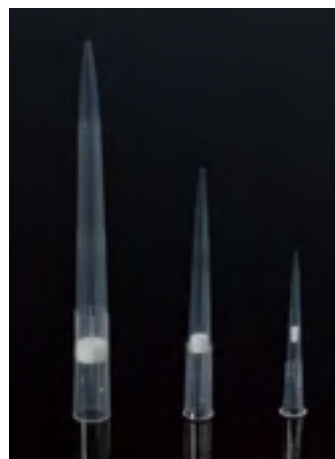

## Features

- Tips are made of medical grade polypropylene, and filters are made of highly hydrophobic UHMWPE
- Filters prevent cross-contamination and damage to samples, ensure accurate and precise sample aspiration, and protect the user by preventing sample liquid or vapor from entering the pipette body
- Standard filter tips and low retention filter tips available in all sizes
- Low retention treated tips undergo a coating-free treatment and will not contaminate samples
- All filter tips are autoclavable
- Available in racked package (sterile) and bulk package (non-sterile)

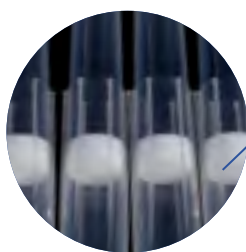

Small and uniform filter pore size ensures the accuracy and precision of sample aspiration

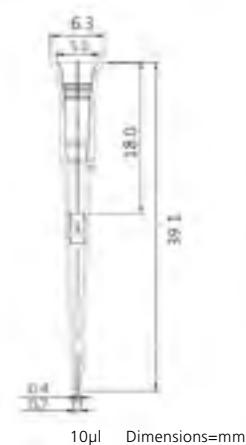

Cat #	Volume	Color	Sterile	Low Retention	Unit
22-0010	10µl	Natural	No	No	1,000 /Bag/Pack, 10 Packs /Case
22-0011	10µl	Natural	No	Yes	1,000 /Bag/Pack, 10 Packs /Case
23-0010	10µl	Natural	Yes	No	96 /Rack, 10 Racks/Pack, 10 Packs/Case
23-0011	10µl	Natural	Yes	Yes	96 /Rack, 10 Racks/Pack, 10 Packs/Case
22-0200	200µl	Natural	No	No	1,000 /Bag/Pack, 10 Packs /Case
22-0201	200µl	Natural	No	Yes	1,000 /Bag/Pack, 10 Packs /Case
23-0200	200µl	Natural	Yes	No	96 /Rack, 10 Racks/Pack, 10 Packs/Case
23-0201	200µl	Natural	Yes	Yes	96 /Rack, 10 Racks/Pack, 10 Packs/Case
22-1000	1000µl	Natural	No	No	1,000 /Bag/Pack, 10 Packs /Case
22-1001	1000µl	Natural	No	Yes	1,000 /Bag/Pack, 10 Packs /Case
23-1000	1000µl	Natural	Yes	No	96 /Rack, 6 Racks/Pack, 10 Packs/Case
23-1001	1000µl	Natural	Yes	Yes	96 /Rack, 6 Racks/Pack, 10 Packs/Case

# Pipet Tip Compatibility

Pipettor Brand/Make	Volume Range	Volume/Biohit Tip	0.5-10µl	20-0010	1-200µl	21-0010	20-0200	100-1000µl	20-1000	100-1000µl	21-1000	100-1000µl	20-1250	0.5-10µl	21-1250	0.5-10µl	22-0010	0.5-10µl	22-0011	0.5-10µl	23-0010	1-200µl	23-0011	1-200µl	22-0200	1-200µl	22-0201	1-200µl	23-0200	100-1000µl	23-0201	100-1000µl	22-1000	100-1000µl	22-1001	100-1000µl	23-1000				
Axygen Axytip (single channel)	0.1-2µl		✓	✓									✓	✓	✓	✓																									
	0.5-10µl		✓	✓									✓	✓	✓	✓																									
	2-20µl				✓	✓																																			
	5-50µl				✓	✓																																			
	10-100µl				✓	✓																																			
	20-200µl				✓	✓																	✓	✓	✓	✓															
	50-250µl																																								
100-1000µl																														✓	✓	✓									
Axygen Axytip (multichannel)	1-10µl		✓	✓									✓	✓	✓	✓																									
	5-50µl				✓	✓																																			
	20-200µl				✓	✓																✓	✓	✓	✓																
	50-300µl				✓	✓																																			
Axygen Axytip-16	0.2-2µl																																								
	0.5-10µl																																								
	5-50µl																																								
Biohit Proline (single channel)	0.2-10µl		✓	✓									✓	✓	✓	✓																									
	5-100µl				✓	✓																																			
	10-250µl				✓	✓																✓	✓	✓	✓																
	10-500µl						✓	✓	✓	✓																				✓	✓	✓									
	50-1000µl						✓	✓	✓	✓																			✓	✓	✓										
Biohit Proline (multichannel)	0.2-10µl		✓	✓									✓	✓	✓	✓																									
	5-100µl				✓	✓																✓	✓	✓	✓																
	25-250µl				✓	✓																✓	✓	✓	✓																
Biohit e-Line (single channel)	1-10µl		✓	✓									✓	✓	✓	✓																									
	5-120µl				✓	✓																																			
	10-300µl				✓	✓																																			
	50-1000µl						✓	✓	✓	✓																			✓	✓	✓										
Biohit e-Line (multichannel)	0.2-10µl		✓	✓									✓	✓	✓	✓																									
	5-120µl				✓	✓																																			
	10-300µl				✓	✓																																			
Biohit m-Line (single channel)	0.5-10µl																																								
	2-20µl				✓	✓																																			
	10-100µl				✓	✓																																			



# Pipet Tip Compatibility

Pipettor Brand/Make	Volume Range	Volume/BioLogix Tip	0.5-10µl	20-0010	0.5-10µl	21-0010	1-200µl	20-0200	1-200µl	21-0200	100-1000µl	20-1000	100-1000µl	21-1000	100-1000µl	20-1250	0.5-10µl	21-1250	0.5-10µl	22-0010	0.5-10µl	22-0011	0.5-10µl	23-0010	1-200µl	23-0011	1-200µl	22-0200	1-200µl	22-0201	1-200µl	23-0200	100-1000µl	23-0201	100-1000µl	22-1000	100-1000µl	22-1001	100-1000µl	23-1000								
Labnet Labpette (single channel)	0.1-2µl		✓	✓													✓	✓	✓	✓																												
	0.5-10µl		✓	✓													✓	✓	✓	✓																												
	2-20µl				✓	✓																																										
	10-100µl				✓	✓																																										
	20-200µl				✓	✓																			✓	✓	✓	✓																				
	100-1000µl						✓	✓	✓	✓																									✓	✓	✓											
Labnet Labpette (multichannel)	1-10µl		✓	✓													✓	✓	✓	✓																												
	5-50µl				✓	✓																																										
	20-200µl				✓	✓																		✓	✓	✓	✓																					
	50-300µl				✓	✓																		✓	✓	✓	✓																					
Labnet BioPette E (single channel)	0.5-10µl		✓	✓													✓	✓	✓	✓																												
	2-20µl		✓	✓													✓	✓	✓	✓																												
	10-200µl				✓	✓																		✓	✓	✓	✓																					
	100-1000µl						✓	✓	✓	✓																										✓	✓	✓										
Labnet BioPette E (multichannel)	0.5-10µl		✓	✓													✓	✓	✓	✓																												
	2-20µl		✓	✓													✓	✓	✓	✓																												
	10-200µl				✓	✓																		✓	✓	✓	✓																					
	100-1000µl						✓	✓	✓	✓																											✓	✓	✓									
MatrixImpact/ Impact <sup>+</sup> (s/mc)	2-125µl				✓	✓																																										
	5-250µl																							✓	✓	✓	✓																					
	15-1250µl											✓	✓																																			
Nichiryo/Oxford Benchmate	0.5-10µl		✓	✓													✓	✓	✓	✓																												
	2-20µl				✓	✓																																										
	10-50µl				✓	✓																																										
	10-100µl																																															
	40-200µl																																															
	100-1000µl																																															
Rainin EDP3 (single channel)	E-MIC-10,0.5-10µl		✓	✓													✓	✓	✓	✓																												
	E2-25,2.5-25µl				✓	✓																																										
	E2-100,10-100µl				✓	✓																																										
	E2-250,25-250µl				✓	✓																			✓	✓	✓	✓																				
E2-1000,100-1000µl						✓	✓	✓	✓																																							

# Pipet Tip Compatibility

0.5-10µl	0.5-10µl 20-0010	1-200µl 21-0010	1-200µl 20-0200	100-1000µl 21-0200	100-1000µl 20-1000	100-1000µl 21-1000	100-1000µl 20-1250	0.5-10µl 21-1250	0.5-10µl 22-0010	0.5-10µl 22-0011	0.5-10µl 23-0010	1-200µl 23-0011	1-200µl 22-0200	1-200µl 22-0201	1-200µl 23-0200	100-1000µl 23-0201	100-1000µl 22-1000	100-1000µl 22-1001	Volume/Biohit Tip	Volume Range	Pipettor Brand/Make
✓	✓							✓	✓	✓	✓									0.1-10µl	Eppendorf Reference (single channel)& (multichannel)
		✓	✓																	2-20µl	
		✓	✓																	10-100µl	
		✓	✓									✓	✓	✓	✓					20-200µl	
				✓	✓	✓	✓					✓	✓	✓	✓	✓	✓	✓		100-1000µl	
✓	✓							✓	✓	✓	✓									0.1-2.5µl	Eppendorf Research (singlechannel)
✓	✓							✓	✓	✓	✓									0.5-10µl	
		✓	✓																	2-20µl	
		✓	✓																	10-100µl	
		✓	✓									✓	✓	✓	✓					25-200µl	
				✓	✓	✓	✓										✓	✓	✓	100-1000µl	
✓	✓							✓	✓	✓	✓									0.5-10µl	Eppendorf Research (multichannel)
																				5-100µl	
		✓	✓																	50-100µl	
		✓	✓									✓	✓	✓	✓					20-300µl	
		✓	✓									✓	✓	✓	✓					30-300µl	
		✓	✓	✓	✓												✓	✓	✓	50-1200µl	
✓	✓							✓	✓	✓	✓									0.2-10µl	Thermo Scientific Finnpiptette (single channel)
✓	✓							✓	✓	✓	✓									0.5-10µl	
		✓	✓																	5-40µl	
		✓	✓									✓	✓	✓	✓					40-200µl	
				✓	✓	✓	✓										✓	✓	✓	100-1000µl	
				✓	✓	✓	✓										✓	✓	✓	200-1000µl	
		✓	✓																	5-50µl	Thermo Scientific Finnpiptette (multichannel)
		✓	✓									✓	✓	✓	✓					50-300µl	
✓	✓							✓	✓	✓	✓									P2, 0.1-2µl	Gilson Pipetman (single channel)
✓	✓							✓	✓	✓	✓									P10, 0.2-10µl	
		✓	✓																	P20, 2-20µl	
		✓	✓																	P100, 10-100µl	
		✓	✓									✓	✓	✓	✓					P200, 20-200µl	
				✓	✓	✓	✓										✓	✓	✓	P1000, 100-1000µl	
		✓	✓									✓	✓	✓	✓					P200-M8, 20-200µl (m/ch)	





# Transfer Pipets



## Features

- Polyethylene pipettes will not shatter or break
- An excellent alternative to Pasteur pipettes and rubber bulbs
- Evenly distributed thickness ensures uniform suction force
- Gamma radiation sterilized option available
- Available wrapped individually (sterile) or in bulk package (non-sterile)

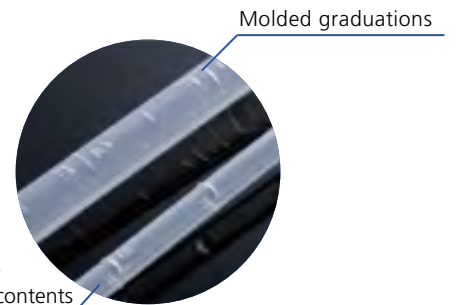

Transparent wall permits easy viewing of pipette contents

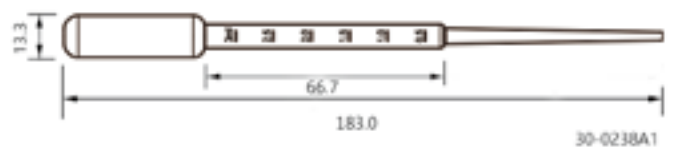
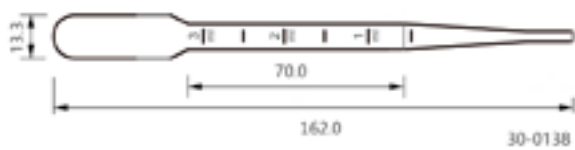
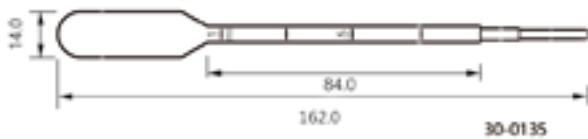

Dimensions = mm

Cat #	Length	Graduated To	Sterile	Package	Unit
30-0135	162.0mm	1ml	No	Bulk	500 /Pack, 4 Packs/Case
30-0135A1	162.0mm	1ml	Yes	Individually Wrapped	1 /Bag, 500 Bags/Pack, 4 Packs/Case
30-0138	162.0mm	3ml	No	Bulk	500 /Pack, 4 Packs/Case
30-0138A1	162.0mm	3ml	Yes	Individually Wrapped	1 /Bag, 500 Bags/Pack, 4 Packs/Case
30-0238A1	183.0mm	3ml	Yes	Individually Wrapped	1 /Bag, 500 Bags/Pack, 4 Packs/Case

# Solution Basins

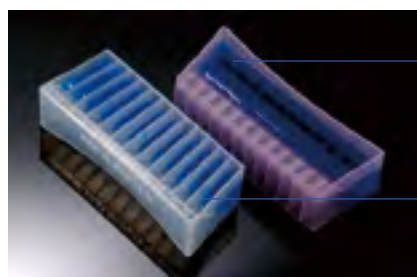

Both sides are functional

## Features

- Made of PVC, polystyrene (PS), or strong polypropylene (PP)
- PVC basins have transparent walls to permit easy viewing of contents
- Polypropylene basins are chemically resistant to alcohols and mild organic solvents
- PS one-channel basins are available in three sizes: 25ml, 55ml, and 100ml; 25ml and 55ml basins have a V-shaped bottom design
- PVC one-channel basins have a capacity of 55ml and a V-shaped bottom design
- PP 12-channel basins are double sided: the 12-channel side has a capacity of 5ml per channel; the other side (single-channel) has a capacity of 50ml
- PP 12-channel basins are available in assorted colors: clear, blue, green, pink, and yellow
- PS basins are individually packaged (sterile); PVC and PP basins are bulk packaged (non-sterile)

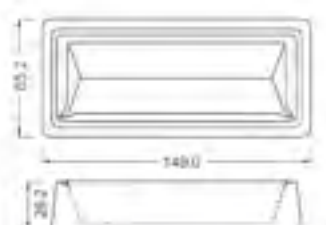

25-0051/52/0052



25-1025



25-1202

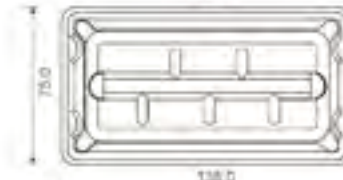

25-1100

Dimensions = mm

Cat #	Volume	Material	Color	Sterile	Package	Unit
25-1025	25ml	PS	White	Yes	Individually Wrapped	1 /Bag, 100 Bags/Case
25-1202	50ml	PP	Assorted Colors	No	Bulk	25 /Bag, 4 Bags/Case
25-0052	55ml	PVC	Clear	No	Bulk	100 /Bag, 8 Bags/Case
25-0051	55ml	PS	White	Yes	Individually Wrapped	1 /Bag, 100 Bags/Case
25-1100	100ml	PS	White	Yes	Individually Wrapped	1 /Bag, 50 Bags/Case



## Features

- Made of strong, medical grade polypropylene, autoclavable
- Tri-corner design provides three dripless pouring spouts
- Six different sizes meet different needs

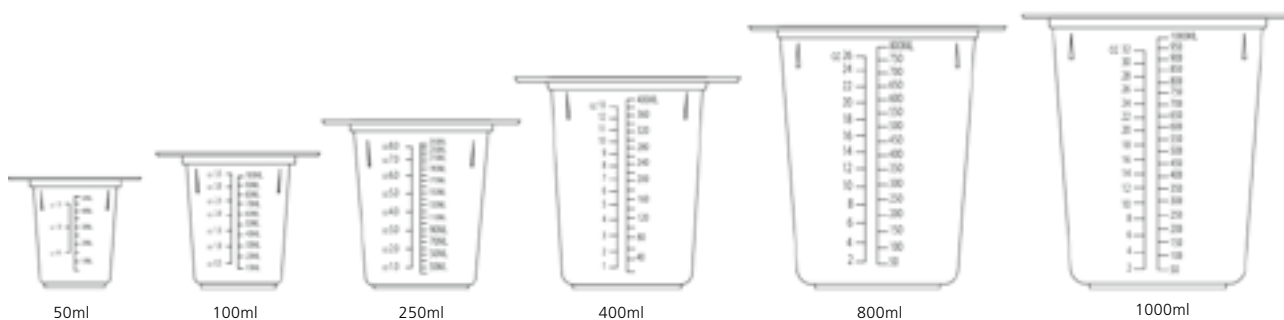

Cat #	Volume	Sterile	Unit
93-0050	50ml	No	25 Pieces/Sleeve, 4 Sleeves/Case
93-0100	100ml	No	25 Pieces/Sleeve, 4 Sleeves/Case
93-0250	250ml	No	25 Pieces/Sleeve, 4 Sleeves/Case
93-0400	400ml	No	25 Pieces/Sleeve, 4 Sleeves/Case
93-0800	800ml	No	25 Pieces/Sleeve, 4 Sleeves/Case
93-1000	1,000ml	No	25 Pieces/Sleeve, 4 Sleeves/Case

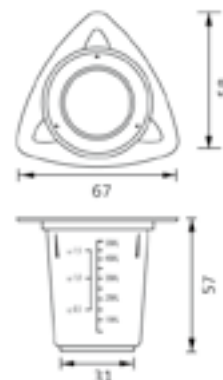

Dimensions = mm

# Reagent Bottles

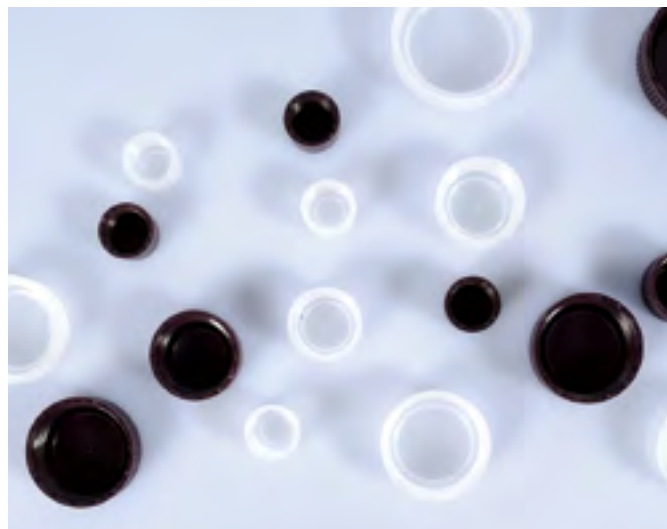

## Features

- Made of durable medical grade polypropylene or high-density polyethylene
- Uniform wall thickness and strength, impact-resistant, great chemical resistance to most acid, alkali and alcohol
- Polypropylene bottles are autoclavable
- Wide-mouth design enables the superior sealing performance, and the convenience for filling liquid
- Linerless caps provide the ultimate in leakproof protection without the use of liner that can wrinkle, cause leaks or contaminate your reagents
- Natural and brown bottles are available
- Brown bottles reduce UV light transmissions to protect light-sensitive liquids  
Natural bottles are convenient to observe inner items
- Various volumes are available: 5ml, 8ml, 10ml, 15ml, 30ml, 60ml, 125ml, 200ml, 250ml, 500ml, and 1000ml

Cat # ( Natural )	Cat # ( Brown )	Volume	Material	Unit
04-0005	04-1005	5ml	PP	2000 /Case
04-0010	04-1010	10ml	PP	1200 /Case
04-0015	04-1015	15ml	PP	1200 /Case
04-0030	04-1030	30ml	PP	800 /Case
04-0060	04-1060	60ml	PP	400 /Case
04-0125	04-1125	125ml	PP	250 /Case
04-0200	04-1200	200ml	PP	200 /Case
04-0250	04-1250	250ml	PP	150 /Case
04-0500	04-1500	500ml	PP	120 /Case
04-2008	04-3008	8ml	Bottles: HDPE, Caps: PP	1000 /Case
04-2015	04-3015	15ml	Bottles: HDPE, Caps: PP	1000 /Case
04-2030	04-3030	30ml	Bottles: HDPE, Caps: PP	400 /Case
04-2060	04-3060	60ml	Bottles: HDPE, Caps: PP	650 /Case
04-2125	04-3125	125ml	Bottles: HDPE, Caps: PP	350 /Case
04-2250	04-3250	250ml	Bottles: HDPE, Caps: PP	200 /Case
04-2500	04-3500	500ml	Bottles: HDPE, Caps: PP	100 /Case
04-2100	04-3100	1000ml	Bottles: HDPE, Caps: PP	50 /Case



## Features

- Tubes: made of medical grade polystyrene or polypropylene
- Caps: made of medical grade polyethylene
- Tubes are available in two sizes: 12 x 75mm and 13 x 100mm

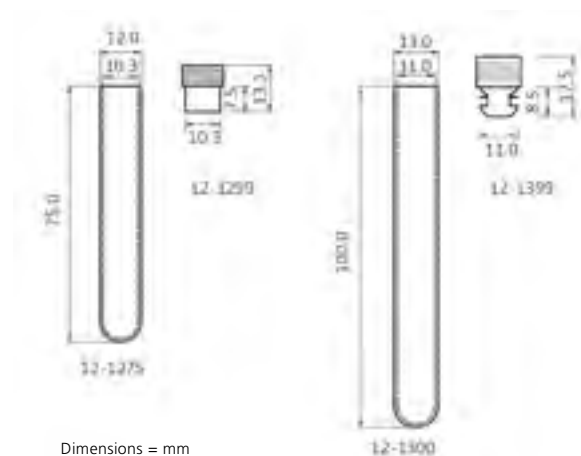

Cat #	Description	Size(mm)	Material	Color	Volume	Sterile	Unit
12-1275	Tube	12x75	PS	Clear	5ml	No	500 /Bag, 4 Bags/Case
12-2275	Tube	12x75	PP	Clear	5ml	No	500 /Bag, 4 Bags/Case
12-1300	Tube	13x100	PS	Clear	8ml	No	250 /Bag, 8 Bags/Case
12-1299	Cap	12x13.5	PE	Blue	-	No	1,000 /Bag, 2 Bags/Case
12-1399	Cap	13x17.5	PE	Red	-	No	1,000 /Bag, 2 Bags/Case

# Slide Storage Boxes

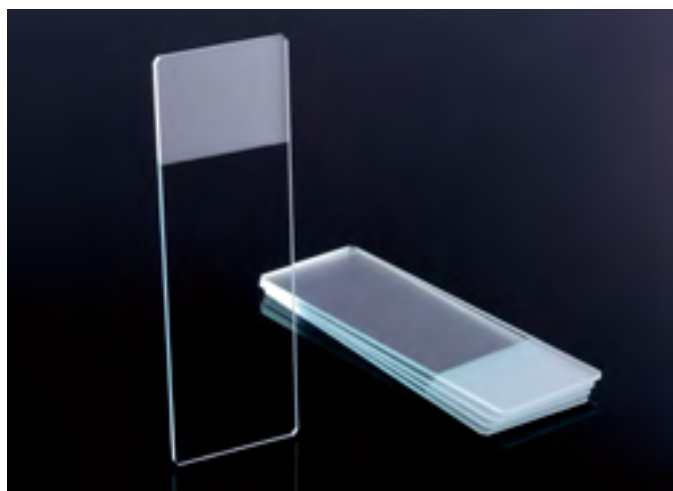
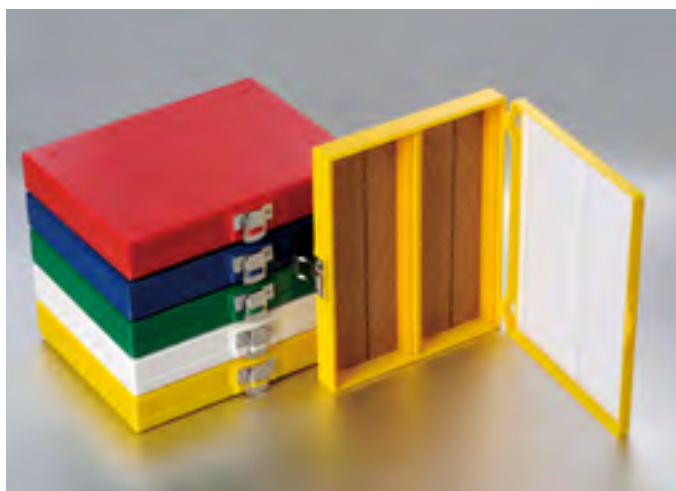

## Features

### Microscope Slides

- Made of high quality, highly transparent glass
- Slide faces are highly polished  
Ground edges prevent chipping and personal injury
- Slides with frosted area are convenient for labeling and storage  
Slides without frosted area have a larger usable surface area

### Slide Storage Boxes

- Made of strong ABS material
- Available in 25-place or 100-place sizes
- Traditional cork or foam lining available
- 5 assorted colors available: red, yellow, green, blue, and white
- Stores 25mm × 75mm microscope slides
- Each slot is numbered to correspond to the slide inventory sheet inside the lid
- 100-place slide boxes are secured with a rust-resistant clasp and hinge pin

## Microscope Slides

Cat #	Material	Type	Size (mm)	Sterile	Unit
7101	Clear Glass	Plain Slides	25.4 x 76.2	No	72 /Pack, 50 Packs/Case
7105	Clear Glass	Single Frosted End	25.4 x 76.2	No	72 /Pack, 50 Packs/Case

## Slide Storage Boxes

Cat #	Place	Lining	Color	Sterile	Unit
41-5025	25-place	Foam	Assorted	No	5 /Bag, 4 Bags/Case
41-6025	25-place	Cork	Assorted	No	5 /Bag, 4 Bags/Case
41-5100	100-place	Foam	Assorted	No	5 /Bag, 6 Bags/Case
41-6100	100-place	Cork	Assorted	No	5 /Bag, 6 Bags/Case

# Deep Well Plates

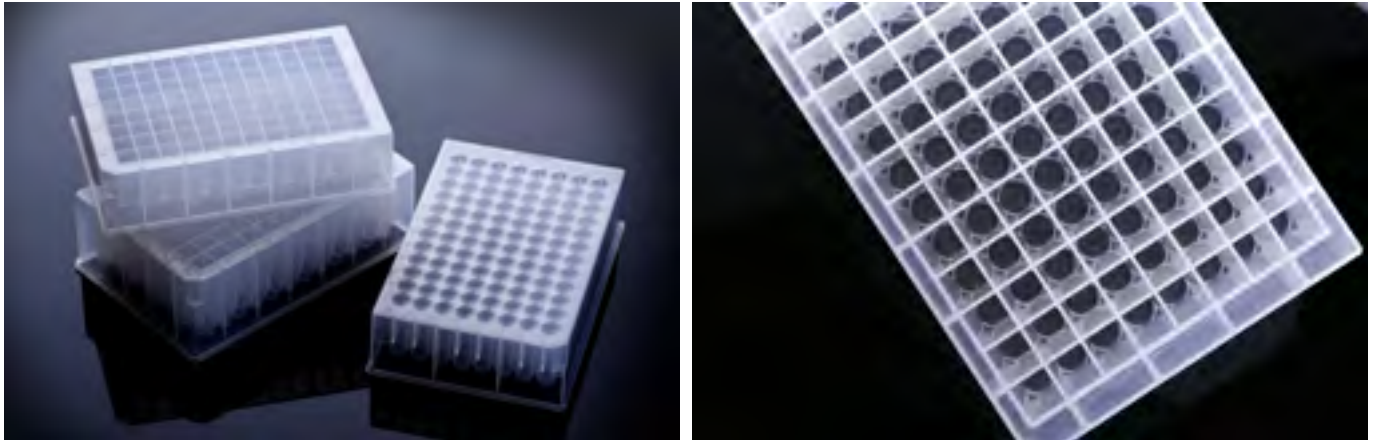

## Features

- Made of medical grade polypropylene
- Chemically resistant to alcohols and mild organic solvents
- Three types available: 1.0ml plates with round wells, and 1.6ml and 2.2ml plates with square wells
- Autoclavable
- Can be sealed with sealing film or silicone covers
- Conforms with the SBS standards for automation
- Compatible with automated DNA extraction equipment

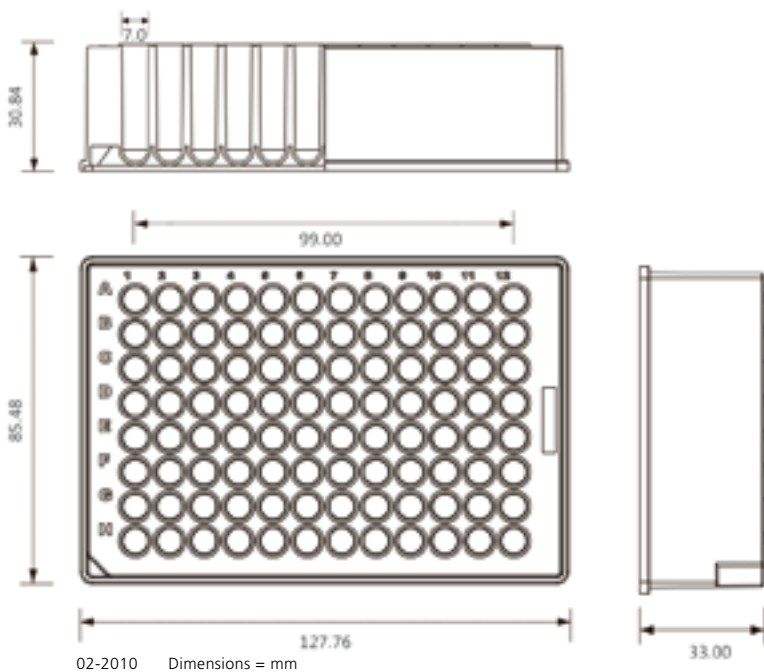

Can be sealed with sealing film or silicone covers

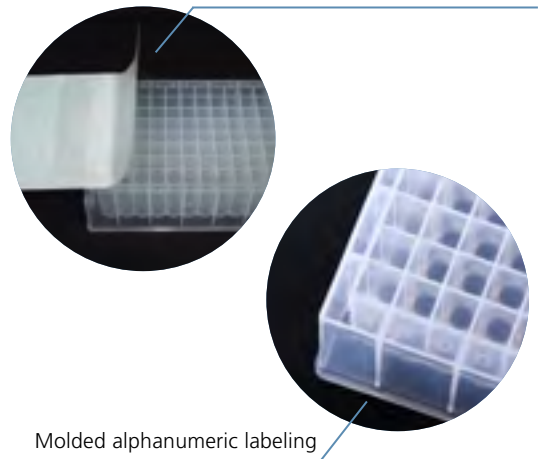

Cat #	Description	Volume	Sterile	Unit
02-2010	Round well	1.0ml	No	24 /Pack, 4 Packs/Case
02-1016	Square well	1.6ml	No	24 /Pack, 4 Packs/Case
02-1022	Square well	2.2ml	No	24 /Pack, 4 Packs/Case

# Gloves



## Features

- Available in powder free latex and powder free nitrile
- Textured fingertips for an improved grip  
Beaded cuff design helps users don gloves efficiently
- Extra length for increased protection  
Biocompatibility tested (ISO 10993)
- Non-sterile



Nitrile material promotes better puncture



Extra-long cuffs

Cat #	Material	Size	Color	Unit
97-1111	Latex	XS	Natural Off-White	100 /Pack, 10 Packs/Case
97-1112	Latex	S	Natural Off-White	100 /Pack, 10 Packs/Case
97-1113	Latex	M	Natural Off-White	100 /Pack, 10 Packs/Case
97-1114	Latex	L	Natural Off-White	100 /Pack, 10 Packs/Case
97-1115	Latex	XL	Natural Off-White	100 /Pack, 10 Packs/Case
97-6111	Nitrile	XS	Dark Blue	100 /Pack, 10 Packs/Case
97-6112	Nitrile	S	Dark Blue	100 /Pack, 10 Packs/Case
97-6113	Nitrile	M	Dark Blue	100 /Pack, 10 Packs/Case
97-6114	Nitrile	L	Dark Blue	100 /Pack, 10 Packs/Case
97-6115	Nitrile	XL	Dark Blue	100 /Pack, 10 Packs/Case



# Cryogenic Series



CryoKING, a brand by Biologix, offers a comprehensive array of biobanking products, including cryogenic vials, universal freezer boxes, universal freezer racks; scanners, handled scanner, and related software; biobanking management software, and more.

CryoKING puts forward the innovative concepts of One Inch Revolution and multiple barcodes per vial. CryoKING products feature professional design and advanced concepts, and are safe and efficient. Their standardization, procedures, and digitization all comply with international standards. The CryoKING system is the leader and complete solution provider in the biorepository kingdom.

To learn more about CryoKING products, please reference CryoKING catalog or visit [WWW.CryoKING.COM](http://WWW.CryoKING.COM).

# Screw Cap Microtubes



## Features

- Made of medical grade polypropylene
- Can be repeatedly frozen and thawed
- Universal screw threads for use
- Tubes fit most common rotors
- Tubes fit standard 1-inch and 2-inch
- Autoclavable to 121°C and freezable to -86°C

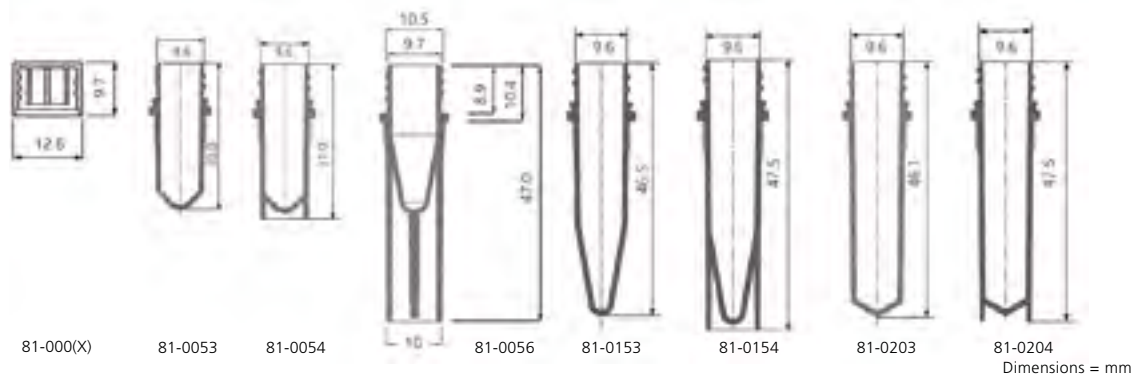

Cat#	Type	Volume	Height	Color	Bottom	Sterile	Unit
81-0053	Tubes	0.5ml	30.0	Clear	Conical	No	500 /Bag/Pack, 10 Packs/Case
81-0054	Tubes	0.5ml	31.0	Clear	Self-Standing	No	500 /Bag/Pack, 10 Packs/Case
81-0055	Tubes	0.5ml	47.5	Brown	Self-Standing	No	500 /Bag/Pack, 10 Packs/Case
81-0056	Tubes	0.5ml	47.5	Clear	Self-Standing	No	500 /Bag/Pack, 10 Packs/Case
81-0153	Tubes	1.5ml	46.5	Clear	Conical	No	500 /Bag/Pack, 10 Packs/Case
81-0154	Tubes	1.5ml	47.5	Clear	Self-Standing	No	500 /Bag/Pack, 10 Packs/Case
81-0203	Tubes	2.0ml	46.1	Clear	Conical	No	500 /Bag/Pack, 10 Packs/Case
81-0204	Tubes	2.0ml	47.5	Clear	Self-Standing	No	500 /Bag/Pack, 10 Packs/Case
81-0000	Caps	-	9.7	Clear	-	No	500 /Bag/Pack, 10 Packs/Case
81-0001	Caps	-	9.7	Pink	-	No	500 /Bag/Pack, 10 Packs/Case
81-0002	Caps	-	9.7	Green	-	No	500 /Bag/Pack, 10 Packs/Case
81-0003	Caps	-	9.7	Blue	-	No	500 /Bag/Pack, 10 Packs/Case
81-0004	Caps	-	9.7	Yellow	-	No	500 /Bag/Pack, 10 Packs/Case
81-0005	Caps	-	9.7	Assorted	-	No	500 /Bag/Pack, 10 Packs/Case
81-0006	Caps	-	9.7	Brown	-	No	500 /Bag/Pack, 10 Packs/Case

\* Caps and tubes are sold separately.

# Cryogenic Vials



## Features

- Made of medical grade polypropylene
- Autoclavable
- Can be repeatedly frozen and thawed
- Universal screw threads
- Vials fit most common rotors
- Vials fit standard 1-inch and 2-inch freezer boxes
- Gamma radiation sterilized
- DNase & RNase free, endotoxin free, and human DNA free
- 81-8204 2ml self-standing vials have a white writing area and black graduations

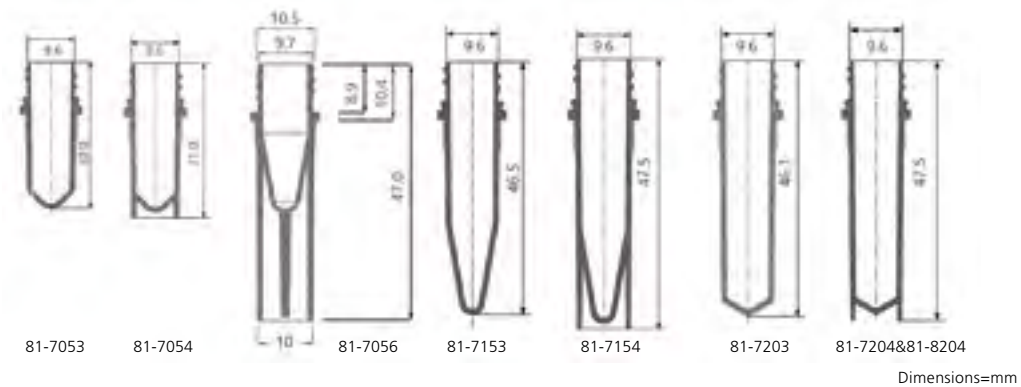

Cat #	Volume	Color	Height	Bottom	Writing Area	Sterile	Unit
81-7053	0.5ml	Clear	30.0	Conical	No	Yes	50 /Bag, 10 Bags/Pack, 4 Packs/Case
81-7054	0.5ml	Clear	31.0	Self-Standing	No	Yes	50 /Bag, 10 Bags/Pack, 4 Packs/Case
81-7055	0.5ml	Brown	47.5	Self-Standing	No	Yes	50 /Bag, 10 Bags/Pack, 4 Packs/Case
81-7056	0.5ml	Clear	47.5	Self-Standing	No	Yes	50 /Bag, 10 Bags/Pack, 4 Packs/Case
81-7153	1.5ml	Clear	46.5	Conical	No	Yes	50 /Bag, 10 Bags/Pack, 4 Packs/Case
81-7154	1.5ml	Clear	47.5	Self-Standing	No	Yes	50 /Bag, 10 Bags/Pack, 4 Packs/Case
81-7203	2.0ml	Clear	46.1	Conical	No	Yes	50 /Bag, 10 Bags/Pack, 4 Packs/Case
81-7204	2.0ml	Clear	47.5	Self-Standing	No	Yes	50 /Bag, 10 Bags/Pack, 4 Packs/Case
81-7205	2.0ml	Brown	47.5	Self-Standing	No	Yes	50 /Bag, 10 Bags/Pack, 4 Packs/Case
81-8204	2.0ml	Clear	47.5	Self-Standing	Yes	Yes	50 /Bag, 10 Bags/Pack, 4 Packs/Case

# Traditional Cryogenic Vials



## Features

- Made of medical grade polypropylene; Autoclavable; and can be repeatedly frozen and thawed.
- 5ml cryogenic vials are available with external screw threads, and 2ml cryogenic vials are available with both external screw threads and internal screw threads. External thread screw vials' caps have no o-ring, which reduces the possibility of contamination.
- Fit 9x9 (81-well) standard cryogenic boxes
- 6 different colored screw caps, tubes with black graduation printing, tubes top with white writing area, base with six corners, convenient to be operated.
- Gamma radiations sterilized RNase and DNase free, endotoxin free and foreign DNA free.
- Pre-set 1D barcodes and numbers on sides for immediate scanning or visual identification.

## Specifications

- Working temperature: stable from -196°C to 121°C
- Suitable for liquid nitrogen freezing

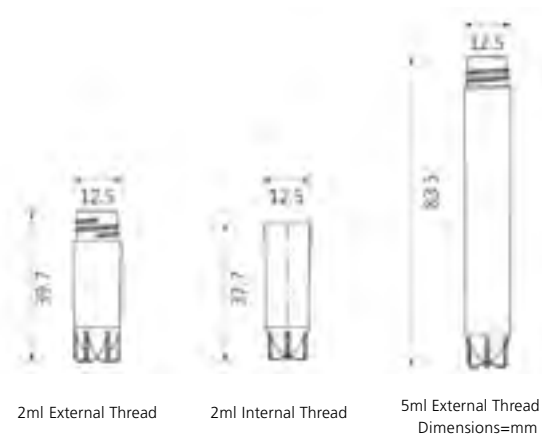

Cat #	Type	Thread Type	Volume	Bottom	Side Barcode	Writing Area	Sterile	Unit
88-321X	Cryogenic Vials	Internal Thread	2ml	Self-Standing	No	Yes	Yes	25 Sets/Bag, 40 Bags/Case
88-320X	Cryogenic Vials	External Thread	2ml	Self-Standing	No	Yes	Yes	25 Sets/Bag, 40 Bags/Case
88-350X	Cryogenic Vials	External Thread	5ml	Self-Standing	No	Yes	Yes	25 Sets/Bag, 40 Bags/Case
88-621X	Cryogenic Vials	Internal Thread	2ml	Self-Standing	Yes	Yes	Yes	25 Sets/Bag, 40 Bags/Case
88-620X	Cryogenic Vials	External Thread	2ml	Self-Standing	Yes	Yes	Yes	25 Sets/Bag, 40 Bags/Case
88-650X	Cryogenic Vials	External Thread	5ml	Self-Standing	Yes	Yes	Yes	25 Sets/Bag, 40 Bags/Case
88-600X	Color marker	-	-	-	-	-	-	100 Sets/Bag, 30 Bags/Case

X--Color of Caps or Color markers : 0-White, 1-Red, 2-Green, 3-Blue, 4-Yellow, 5-Purple



## Features

- Made of medical grade polypropylene, can be repeatedly frozen and thawed
- Vials have a white writing area and black graduations; 6 different colored caps are available
- Vials with pre-set Datamatrix 2D barcodes are available, and the 2D barcodes can be customized
- Use the microscopic imaging technique to pre-set 2D barcodes
- Gamma radiation sterilized, DNase & RNase free, endotoxin free, foreign DNA free
- Some vials have pre-set 1D barcodes and human readable numbers on sides for visual identification, and can be read by various scanners

## Specifications

- Working temperature: stable from -196°C to 121°C
- Suitable for liquid nitrogen freezing

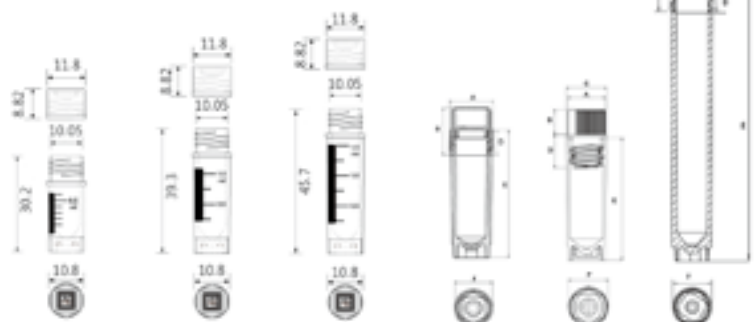

Dimensions = mm



Datamatrix 2D Barcoded vial



Non-barcoded vial

Cat #	Cat# (Upgraded, with Side Barcode)	Thread Type	Volume	Bottom	Bottom Barcode	Writing Area	Sterile	Unit
88-005X	88-605X	External	0.5ml	Self-Standing	No	Yes	Yes	25 Sets/Bag, 40 Bags/Case
88-010X	88-610X	External	1.0ml	Self-Standing	No	Yes	Yes	25 Sets/Bag, 40 Bags/Case
88-015X	88-615X	External	1.5ml	Self-Standing	No	Yes	Yes	25 Sets/Bag, 40 Bags/Case
88-020X	88-720X	External	2.0ml	Self-Standing	No	Yes	Yes	25 Sets/Bag, 40 Bags/Case
88-021X	88-721X	Internal	2.0ml	Self-Standing	No	Yes	Yes	25 Sets/Bag, 40 Bags/Case
88-050X	88-750X	External	5.0ml	Self-Standing	No	Yes	Yes	25 Sets/Bag, 40 Bags/Case
88-105X	88-905X	External	0.5ml	Self-Standing	Yes	Yes	Yes	25 Sets/Bag, 40 Bags/Case
88-110X	88-910X	External	1.0ml	Self-Standing	Yes	Yes	Yes	25 Sets/Bag, 40 Bags/Case
88-115X	88-915X	External	1.5ml	Self-Standing	Yes	Yes	Yes	25 Sets/Bag, 40 Bags/Case
88-120X	88-920X	External	2.0ml	Self-Standing	Yes	Yes	Yes	25 Sets/Bag, 40 Bags/Case
88-121X	88-921X	Internal	2.0ml	Self-Standing	Yes	Yes	Yes	25 Sets/Bag, 40 Bags/Case
88-150X	88-950X	External	5.0ml	Self-Standing	Yes	Yes	Yes	25 Sets/Bag, 40 Bags/Case

X--Cap Color : 0-White, 1-Red, 2-Green, 3-Blue, 4-Yellow, 5-Purple

# CryoKING Combo



## Features

- All you need in one package:
  - CryoKING Vials with pre-set 2D barcodes
  - Pre-assembled inside the CryoKING Boxes
  - Pre-sterilized
- Certified: foreign DNA free, DNase & RNase free, endotoxin free
- Rapidly scans and identifies an entire box full of vials
- Pre-set 1D barcodes and numbers on side for immediate scanning or visual identification.

## Specifications

- Working temperature: stable from -196°C to 121°C
- Suitable for liquid nitrogen freezing

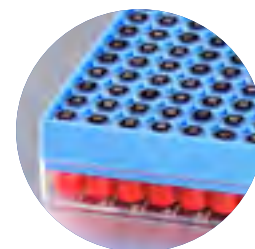
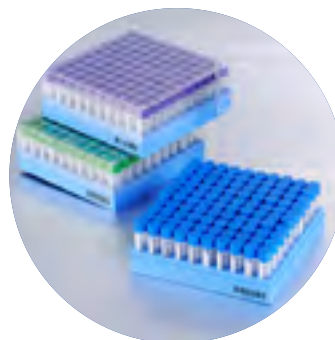

Cat #	Volume	Thread Type	Bottom Barcode on Vials	Side Barcode on Vials	Wells	Dimensions(mm)	Unit
89-305X	0.5ml Vials + 1 inBox	External	Yes	No	100-well	133x133x36	6 Bags/Pack , 2 Packs/Case
89-310X	1.0ml Vials + 2 inBox	External	Yes	No	100-well	133x133x52	6 Bags/Pack , 2 Packs/Case
89-315X	1.5ml Vials + 2 inBox	External	Yes	No	100-well	133x133x52	6 Bags/Pack , 2 Packs/Case
89-320X	2.0ml Vials + 2 inBox	External	Yes	No	100-well	133x133x52	6 Bags/Pack , 2 Packs/Case
89-321X	2.0ml Vials + 2 inBox	Internal	Yes	No	100-well	133x133x52	6 Bags/Pack , 2 Packs/Case
89-350X	5.0ml Vials + 3.75 inBox	External	Yes	No	81-well	133x133x95	6 Bags/Pack , 2 Packs/Case
89-905X	0.5ml Vials + 1 inBox	External	Yes	Yes	100-well	133x133x36	6 Bags/Pack , 2 Packs/Case
89-910X	1.0ml Vials + 2 inBox	External	Yes	Yes	100-well	133x133x52	6 Bags/Pack , 2 Packs/Case
89-915X	1.5ml Vials + 2 inBox	External	Yes	Yes	100-well	133x133x52	6 Bags/Pack , 2 Packs/Case
89-920X	2.0ml Vials + 2 inBox	External	Yes	Yes	100-well	133x133x52	6 Bags/Pack , 2 Packs/Case
89-921X	2.0ml Vials + 2 inBox	Internal	Yes	Yes	100-well	133x133x52	6 Bags/Pack , 2 Packs/Case
89-950X	5.0ml Vials + 3.75 inBox	External	Yes	Yes	81-well	133x133x95	6 Bags/Pack , 2 Packs/Case

X--Cap Color : 0-White, 1-Red, 2-Green, 3-Blue, 4-Yellow, 5-Purple



## Features

- 2D barcodes on 96-well format cryogenic vials are easy to be read
- 2D barcode and human-readable numbers on the side of SBS format racks; 2D barcode at the bottom of racks, cryogenic vials and racks can be traced at the same time
- Simple yet powerful mechanical locking function and slide the buttons on both sides to unlock
- Laser etched 2D barcodes, resistant to DMSO and other organic solvents
- SBS format rack fits 96-well format cryogenic vials perfectly for automatic operations

## Specifications

- Working temperature: stable from -196°C to 121°C
- Suitable for liquid nitrogen freezing



## 96-well SBS Cryogenic Vials

Cat #	Type	Thread Type	Volume	Bottom	Bottom Barcode	Writing Area	Sterile	Unit
88-403X	Vials	Internal	300µl	Self-Standing	Yes	No	Yes	96 Sets/Bag, 10 Bags/Pack, 2 Packs/Case
88-405X	Vials	Internal	500µl	Self-Standing	Yes	No	Yes	96 Sets/Bag, 10 Bags/Pack, 2 Packs/Case
88-408X	Vials	Internal	750µl	Self-Standing	Yes	No	Yes	96 Sets/Bag, 10 Bags/Pack, 2 Packs/Case
88-410X	Vials	Internal	1000µl	Self-Standing	Yes	No	Yes	96 Sets/Bag, 10 Bags/Pack, 2 Packs/Case

X--Cap Color : 0-White, 1-Red, 2-Green, 3-Blue, 4-Yellow, 5-Purple

## SBS Format Cryogenic Racks

Cat #	Vial Volume	Wells	Color	Dimensions(mm)	Unit
98-4117	300µl & 500µl	96-well	Blue	128x85x35	10 /Pack , 2 Packs/Case
98-4217	750µl & 1000µl	96-well	Blue	128x85x54	10 /Pack , 2 Packs/Case

## SBS Format Combo

Cat #	Description	Bottom Barcode	Side Barcode	Wells	Dimensions(mm)	Unit
89-403X	300µl Vials+Rack	Yes	No	96-well	128x85x35	1 Sets/Bag , 10 Bags/Pack , 2 Packs/Case
89-405X	500µl Vials+Rack	Yes	No	96-well	128x85x35	1 Sets/Bag , 10 Bags/Pack , 2 Packs/Case
89-408X	750µl Vials+Rack	Yes	No	96-well	128x85x54	1 Sets/Bag , 10 Bags/Pack , 2 Packs/Case
89-410X	1000µl Vials+Rack	Yes	No	96-well	128x85x54	1 Sets/Bag , 10 Bags/Pack , 2 Packs/Case

X--Cap Color : 0-White , 1-Red , 2-Green , 3-Blue , 4-Yellow , 5-Purple

## Premium Cardboard Cryogenic Boxes

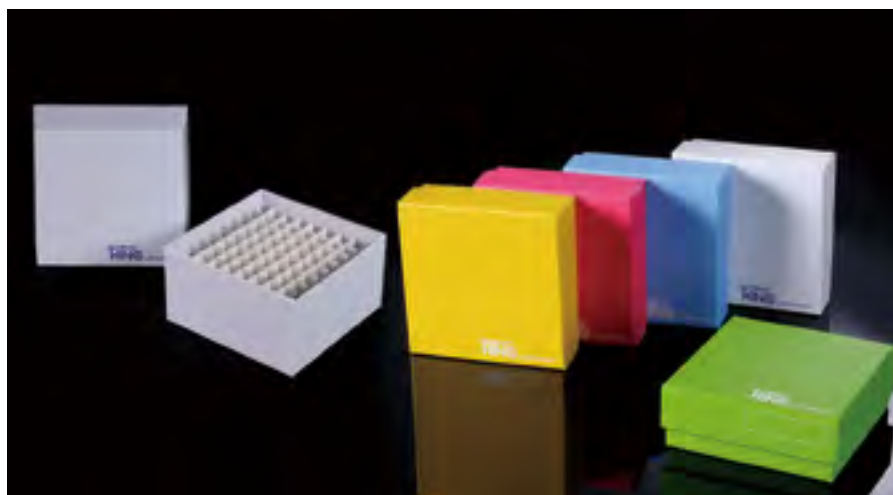

### Features

- Made of durable cardboard with superior white outer coating
- Chemically resistant to alcohols and mild organic solvents
- Five assorted colors available: white, yellow, pink, blue, and green
- White Premium Cardboard Freezer Boxes have a glossy coating, other colors have a matte coating
- Water resistant coating for improved durability
- Superior white 90-1281 & 90-1200 cardboard cryogenic boxes without outer coating are also available
- Holds 0.5ml, 1.5ml, 2.0ml, 5ml and 10ml microtubes and 15ml or 50ml Centrifuge Tubes

### Specifications

- Working temperature: stable from -196°C to 121°C
- Suitable for liquid nitrogen freezing

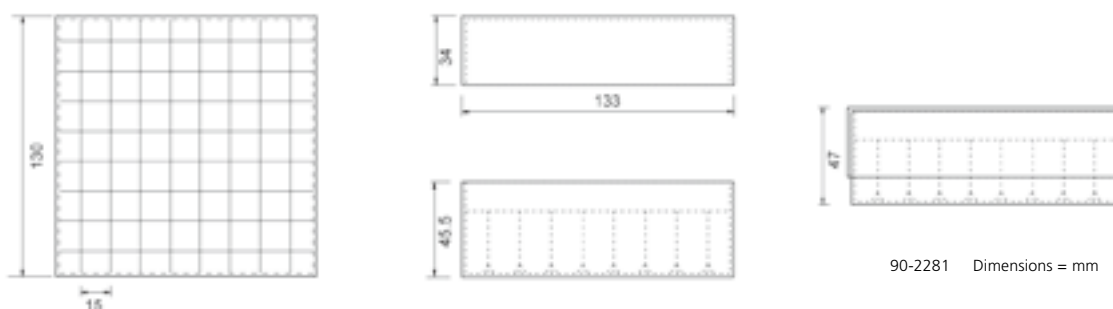

Cat #	Height	Wells	Description	Color	Dimensions (mm)	Unit
90-1281	2 in	81-well	Superior white without outer coating	White	132 x 132 x 53	5 /Bag, 20 Bags/Case
90-1200	2 in	100-well	Superior white without outer coating	White	132 x 132 x 53	5 /Bag, 20 Bags/Case
90-2281	2 in	81-well	White coating, plastic coating	White	133 x 133 x 52	5 /Bag, 20 Bags/Case
90-5281	2 in	81-well	Rainbow outer coating, matte coating	Assorted Colors	133 x 133 x 52	5 /Bag, 20 Bags/Case
90-2200	2 in	100-well	White coating, plastic coating	White	133 x 133 x 52	5 /Bag, 20 Bags/Case
90-5200	2 in	100-well	Rainbow outer coating, matte coating	Assorted Colors	133 x 133 x 52	5 /Bag, 20 Bags/Case
90-2381	3 in	81-well	White coating, plastic coating	White	133 x 133 x 76	5 /Bag, 20 Bags/Case
90-2300	3 in	100-well	White coating, plastic coating	White	133 x 133 x 76	5 /Bag, 20 Bags/Case





## Features

- Made of durable cardboard with a waterproof coating and ABS or polypropylene dividers
- Hinged lid design ensures that lids are never misplaced or mixed up
- Alphanumeric labeling featured on the lid, bottom, and four sides enables quick and easy identification of samples
- Holds 0.5ml/1.5ml/2.0ml/5.0ml microtubes and cryogenic vials

## Specifications

- Suitable for liquid nitrogen freezing (after adding vent holes, and using cardboard dividers)

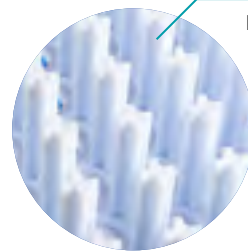
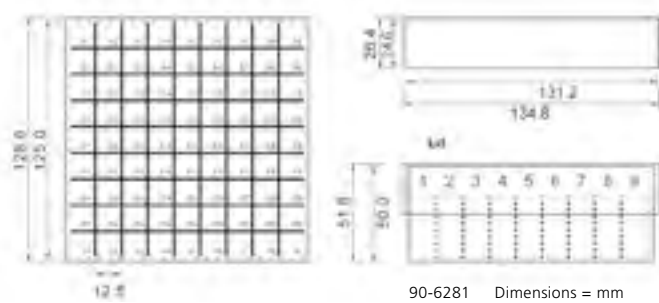

Post-style dividers

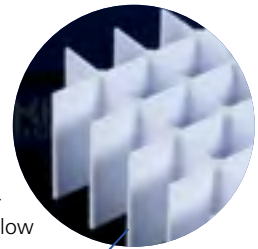

Straight grid divider design, resistant to low temperature

Cat #	Height	Well	Divider Material	Connection	Dimensions (mm)	Unit
90-8100	1in	100-well	PP	No	133 x 133 x 36	5 /Bag, 4 Bags/Case
90-6281	2in	81-well	PP	Rivets	133 x 133 x 52	5 /Bag, 4 Bags/Case
90-8281	2in	81-well	PP	No	133 x 133 x 52	5 /Bag, 4 Bags/Case
90-8200	2in	100-well	PP	No	133 x 133 x 52	5 /Bag, 4 Bags/Case
90-8381	3.75in	81-well	PP	No	133 x 133 x 95	5 /Bag, 4 Bags/Case

# PC Cryogenic Boxes

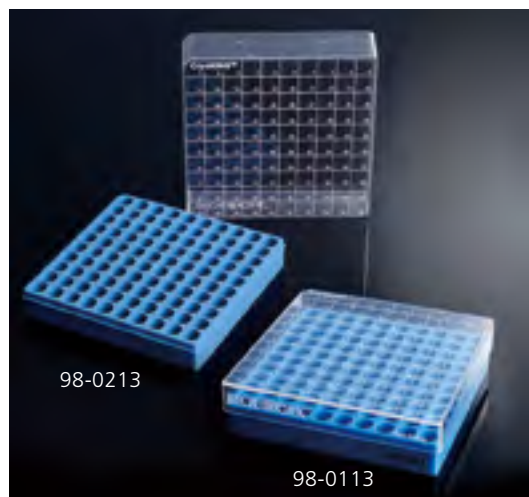

## Features

- Made of tough polycarbonate, chemically resistant to alcohols and mild organic solvents
- Can be repeatedly frozen and thawed
- 5x5 (25-well), 9x9 (81-well), or 10x10 (100-well) boxes available
- Compatible with 0.5ml, 1.5ml, 2.0ml or 5.0ml microtubes and cryogenic vials
- Boxes feature numbered grids for sample identification
- Drain holes and air vents minimize condensation
- Five assorted colors available

## Specifications

- Suitable for storage in mechanical freezers or liquid nitrogen
- Temperature range: stable from -196°C to 121°C

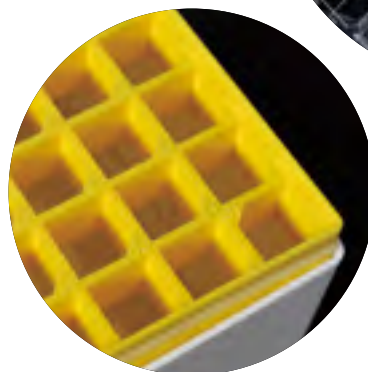

Cat #	Height	Wells	Color	Dimensions (mm)	Unit
98-0113	1 in	100-well	Blue	133 x 133 x 36	3 /Bag, 4 Bags/Case
90-9250	2 in	25-well	Assorted Colors	75 x 75 x 52	5 /Bag, 6 Bags/Case
90-9009	2 in	81-well	Assorted Colors	133 x 133 x 52	5 /Bag, 4 Bags/Case
98-0213	2 in	100-well	Blue	133 x 133 x 52	3 /Bag, 4 Bags/Case
90-9210	2 in	100-well	Assorted Colors	133 x 133 x 52	5 /Bag, 4 Bags/Case
90-9381	3.75 in	81-well	Assorted Colors	133 x 133 x 95	5 /Bag, 4 Bags/Case
98-0313	3.75 in	81-well	Blue	133 x 133 x 95	3 /Bag, 4 Bags/Case

# PP Cryogenic Boxes



## Features

- Made of polypropylene, chemically resistant to alcohols and mild organic solvents
- Can be repeatedly frozen and thawed
- 5x5 (25-well), 9x9 (81-well), or 10x10 (100-well) boxes available
- Compatible with 0.5ml, 1.5ml or 2.0ml microtubes and cryogenic vials
- Boxes feature numbered grids for sample identification
- Drain holes and air vents minimize condensation
- Five assorted colors available

## Specifications

- Suitable for storage in mechanical freezers
- Temperature range: stable from -86°C to 121°C



Number grid for sample identification



Convenient sample organization

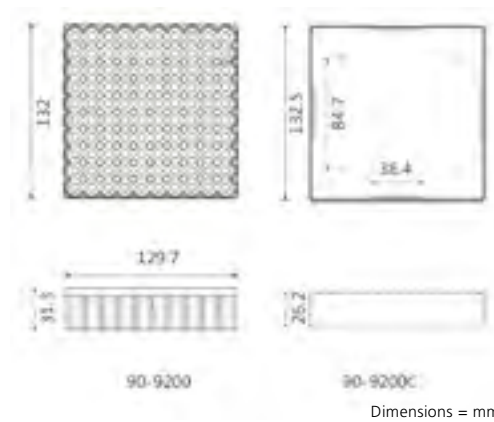

Cat #	Height	Wells	Color	Dimensions (mm)	Unit
90-9025	2 in	25-well	Assorted Colors	75 x 75 x 52	5 /Bag, 6 Bags/Case
90-9081	2 in	81-well	Assorted Colors	133 x 133 x 52	5 /Bag, 4 Bags/Case
90-9100	2 in	100-well	Assorted Colors	141 x 154 x 55	5 /Bag, 4 Bags/Case
90-9200	2 in	100-well	Assorted Colors	133 x 133 x 52	5 /Bag, 4 Bags/Case

# Freezer Racks



## Sliding Drawer Freezer Racks

- Made of corrosion-resistant stainless steel
- Ideal for storage of 1 inch and 2 inch standard size cryogenic boxes
- Fits most standard upright freezers
- Sliding Drawer Freezer Racks include folded rails to reduce frost
- Flanging design reduces scratching
- Handle design enables easy removal from the shelf
- Colored labels for drawer/sample identification
- Special sliding drawer freezer racks can be customized

Cat #	Description	Dimensions(mm) (D x W x H)	Capacity (D x H Configuration)	Storage box size (mm)
99-1216	Sliding Drawer	564 x 141 x 229	4 x 4	133 x 133 x 52
99-1220	Sliding Drawer	564 x 141 x 285	4 x 5	133 x 133 x 52
99-1224	Sliding Drawer	564 x 141 x 341	4 x 6	133 x 133 x 52
99-1124	Sliding Drawer	564 x 141 x 245	4 x 6	133 x 133 x 36
99-1128	Sliding Drawer	564 x 141 x 285	4 x 7	133 x 133 x 36
99-1132	Sliding Drawer	564 x 141 x 325	4 x 8	133 x 133 x 36
99-7216	Sliding Drawer	564 x 141 x 229	4 x 4	133 x 133 x 52
99-7220	Sliding Drawer	564 x 141 x 285	4 x 5	133 x 133 x 52
99-7224	Sliding Drawer	564 x 141 x 341	4 x 6	133 x 133 x 52
99-7124	Sliding Drawer	564 x 141 x 245	4 x 6	133 x 133 x 36
99-7128	Sliding Drawer	564 x 141 x 285	4 x 7	133 x 133 x 36
99-7132	Sliding Drawer	564 x 141 x 325	4 x 8	133 x 133 x 36

\*Can be customized



## Side Access Drawer Freezer Racks

- Made of corrosion-resistant stainless steel
- Ideal for storage of 1 inch and 2 inch standard size cryogenic boxes
- Fits most standard upright freezers
- Special sliding drawer freezer racks can be customized

Cat #	Description	Dimensions(mm) (D x W x H)	Capacity (D x H Configuration)	Storage box size(mm)
99-5212	Side Access Drawer	420 x 140 x 240	3 x 4	133 x 133 x 52
99-5215	Side Access Drawer	420 x 140 x 300	3 x 5	133 x 133 x 52
99-5216	Side Access Drawer	560 x 140 x 240	4 x 4	133 x 133 x 52
99-5220	Side Access Drawer	560 x 140 x 300	4 x 5	133 x 133 x 52

\*Can be customized



## Frame Type Freezer Racks

- Made of corrosion-resistant stainless steel
- Ideal for storage of 1 inch and 2 inch standard size cryogenic boxes
- Fits most standard upright freezers
- Simple structure and lightweight design helps manage cryogenic boxes efficiently
- Special sliding drawer freezer racks can be customized

Cat #	Description	Dimensions (mm) (D x W x H)	Capacity (D x H Configuration)	Storage box size (mm)
99-2118	Frame Type	420 x 137 x 244	3 x 6	133 x 133 x 36
99-2121	Frame Type	420 x 137 x 284	3 x 7	133 x 133 x 36
99-2120	Frame Type	560 x 137 x 204	4 x 5	133 x 133 x 36
99-2124	Frame Type	560 x 137 x 244	4 x 6	133 x 133 x 36
99-2212	Frame Type	422 x 137 x 229	3 x 4	133 x 133 x 52
99-2215	Frame Type	422 x 137 x 284	3 x 5	133 x 133 x 52
99-2216	Frame Type	560 x 137 x 229	4 x 4	133 x 133 x 52
99-2220	Frame Type	560 x 137 x 284	4 x 5	133 x 133 x 52
99-2224	Frame Type	560 x 137 x 339	4 x 6	133 x 133 x 52
99-2128	Frame Type	560 x 137 x 284	4 x 7	133 x 133 x 36
99-2132	Frame Type	560 x 137 x 315	4 x 8	133 x 133 x 36
99-2230	Frame Type	700 x 137 x 339	5 x 6	133 x 133 x 52

\*Can be customized



## Vertical Type Freezer Racks

- Made of corrosion-resistant stainless steel
- Ideal for storage of 1 inch and 2 inch standard size cryogenic boxes
- Fits most standard upright freezers
- Especially suitable for liquid nitrogen freezing
- Special sliding drawer freezer racks can be customized

Cat #	Description	Dimension (mm) (H x W x D)	Capacity (D x H Configuration)	Storage box size (mm)
99-6206	Vertical Type	338 x 140 x 140	1 x 6	133 x 133 x 52
99-6207	Vertical Type	394 x 140 x 140	1 x 7	133 x 133 x 52
99-6208	Vertical Type	450 x 140 x 140	1 x 8	133 x 133 x 52
99-6209	Vertical Type	506 x 140 x 140	1 x 9	133 x 133 x 52
99-6210	Vertical Type	562 x 140 x 140	1 x 10	133 x 133 x 52
99-6211	Vertical Type	618 x 140 x 140	1 x 11	133 x 133 x 52
99-6212	Vertical Type	674 x 140 x 140	1 x 12	133 x 133 x 52
99-6213	Vertical Type	730 x 140 x 140	1 x 13	133 x 133 x 52

\*Can be customized

# Freezer Racks



## Aluminum Freezer Racks- Frame Type

- Made of high-performance aluminum alloy, the anodic oxidation surface treatment enables sturdiness and corrosion-resistance
- Aluminum racks enables light weight, convenient operation and elegant appearance
- Argon arc welding free, components are connected with small rivets to enable cost-saving in production
- Ideal for storage of 1 inch and 2 inch cryogenic boxes and standard freezers
- Simple structure and lightweight design helps manage cryogenic boxes efficiently

Cat #	Description	Capacity (D x H Configuration)	Dimensions(mm) (D x W x H)	Storage box size (mm)
96-2118	Frame Type	3 x 6	415 x 137 x 244	133 x 133 x 36
96-2121	Frame Type	3 x 7	415 x 137 x 284	133 x 133 x 36
96-2120	Frame Type	4 x 5	552 x 137 x 204	133 x 133 x 36
96-2124	Frame Type	4 x 6	552 x 137 x 244	133 x 133 x 36
96-2128	Frame Type	4 x 7	552 x 137 x 284	133 x 133 x 36
96-2132	Frame Type	4 x 8	552 x 137 x 324	133 x 133 x 36
96-2212	Frame Type	3 x 4	415 x 137 x 228	133 x 133 x 52
96-2215	Frame Type	3 x 5	415 x 137 x 284	133 x 133 x 52
96-2216	Frame Type	4 x 4	552 x 137 x 228	133 x 133 x 52
96-2220	Frame Type	4 x 5	552 x 137 x 284	133 x 133 x 52
96-2224	Frame Type	4 x 6	552 x 137 x 340	133 x 133 x 52
96-2230	Frame Type	5 x 6	689 x 137 x 340	133 x 133 x 52

\*Can be customized



## Aluminum Freezer Racks-Vertical Type

- Made of high-performance aluminum alloy, the anodic oxidation surface treatment enables sturdiness and corrosion-resistance
- Aluminum racks enables light weight, convenient operation and elegant appearance
- Argon arc welding free, components are connected with small rivets to enable cost-saving in production
- Ideal for storage of 1 inch and 2 inch cryogenic boxes and standard freezers
- Especially suitable for liquid nitrogen freezing

Cat #	Description	Capacity (D x H Configuration)	Dimensions(mm) (D x W x H)	Storage box size (mm)
96-6206	Vertical Type	1 x 6	338 x 139 x 140	133 x 133 x 52
96-6207	Vertical Type	1 x 7	394 x 139 x 140	133 x 133 x 52
96-6208	Vertical Type	1 x 8	450 x 139 x 140	133 x 133 x 52
96-6209	Vertical Type	1 x 9	506 x 139 x 140	133 x 133 x 52
96-6210	Vertical Type	1 x 10	562 x 139 x 140	133 x 133 x 52
96-6211	Vertical Type	1 x 11	618 x 139 x 140	133 x 133 x 52
96-6212	Vertical Type	1 x 12	618 x 139 x 140	133 x 133 x 52
96-6213	Vertical Type	1 x 13	730 x 139 x 140	133 x 133 x 52

\*Can be customized

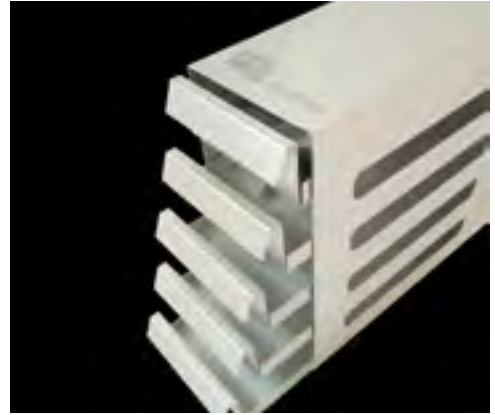

## Aluminum Freezer Racks-Sliding Drawer

- Made of high-performance aluminum alloy, the anodic oxidation surface treatment enables sturdiness and corrosion-resistance
- Aluminum racks enables light weight, convenient operation and elegant appearance
- Argon arc welding free, components are connected with small rivets to enable cost-saving in production
- Ideal for storage of 1 inch and 2 inch cryogenic boxes and standard freezers
- The sliding drawer design with folded rails can avoid frost
- Flanging design reduces scratching, and colored labels on drawers enable rapid drawer/sample identification

Cat #	Description	Capacity (D x H Configuration)	Dimensions(mm) (D x W x H)	Storage box size (mm)
96-1216	Sliding Drawer	4 x 4	564 x 141 x 228	133 x 133 x 52
96-1220	Sliding Drawer	4 x 5	564 x 141 x 284.8	133 x 133 x 52
96-1224	Sliding Drawer	4 x 6	564 x 141 x 341.6	133 x 133 x 52
96-1124	Sliding Drawer	4 x 6	564 x 141 x 245.6	133 x 133 x 36
96-1128	Sliding Drawer	4 x 7	564 x 141 x 286.4	133 x 133 x 36
96-1132	Sliding Drawer	4 x 8	564 x 141 x 327.2	133 x 133 x 36
96-7216	Sliding Drawer	4 x 4	564 x 141 x 231	133 x 133 x 52
96-7220	Sliding Drawer	4 x 5	564 x 141 x 288.5	133 x 133 x 52
96-7224	Sliding Drawer	4 x 6	564 x 141 x 346	133 x 133 x 52
96-7124	Sliding Drawer	4 x 6	564 x 141 x 250	133 x 133 x 36
96-7128	Sliding Drawer	4 x 7	564 x 141 x 291.5	133 x 133 x 36
96-7132	Sliding Drawer	4 x 8	564 x 141 x 333	133 x 133 x 36

\*Can be customized

# Scanners



## CryoKING Wired Handheld Scanner

- Infrared scanning individual cryogenic vials to identify barcodes and 2D barcodes accurately
- Ergonomic handheld design
- Compatible with CryoKING Crown biobanking management software
- Collect sample information rapidly and accurately



## CryoKING Adept

- Can scan linear and 2D barcodes
- Ergonomic, lightweight design
- Wireless, pairs with a computer or mobile device using Bluetooth
- Compatible with our CryoScan app for Windows, Android, and iOS, as well as many other barcode scanning programs

Cat #	Description	Scan Type
CKS-0101	Wired Handheld Scanner Gun	Individual Vial
CKS-0201	Wireless Handheld Scanner Gun	Individual Vial

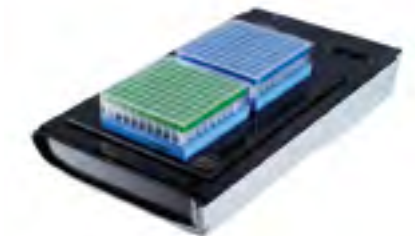

## CryoKING Scanner

- Can scan 200 samples in 5 seconds
- Equipped with 2-Box Scanning frame for free
- Equipped with PC software for free, and can be paired with international database, such as SQL server, Oracle, MySQL, Postgres, HSQL
- Access with CryoKING Crown biobanking management software, and samples information can be collected rapidly and accurately



## CryoKING Maestro Scanner

- Combines advanced optics and computer technology to rapidly scan samples
- Can scan an individual vial or an entire box at once
- Compatible with standard size 8x12, 9x9, or 10x10 cryogenic boxes
- Includes a touch-screen interface
- Manage and export data immediately after scanning
- Export data using Wi-Fi, Bluetooth, or USB connections

Cat #	Description	Scan Type
CKS-1101	AC 100-240V/50Hz/60Hz	Entire Box
CKS-1201	AC 100-240V/50Hz/60Hz	Entire Box or Individual Vial



The CryoKING Crown Biobanking Management Software integrates everything from sample management and storage to packaging and transport into one comprehensive management program. It is the tool of choice for streamlined scientific research and biobanking management.

## Features

- Can be accessed through the CryoKING Cloud service, or hosted locally for use on a laboratory's own LAN
- Designed for use with industry-standard equipment and procedures
- Easy-to-use interface allows users to upload and import existing sample data
- Compatible with the CryoKING Maestro 2nd Generation Scanner for full boxes of 2D-barcoded cryogenic vials
- Currently available in English and Simplified Chinese (more languages coming soon)

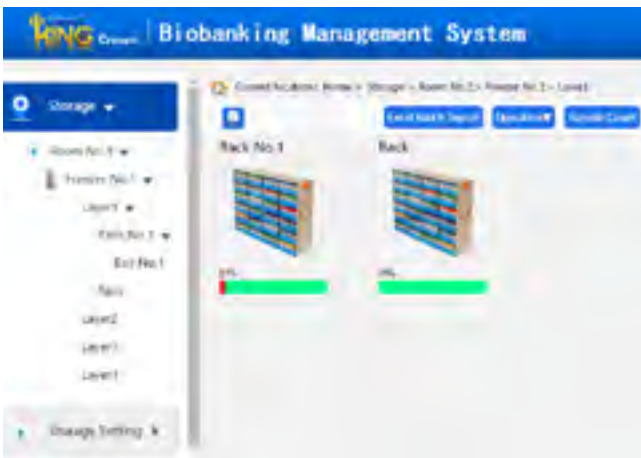

1. Our products (including freezer racks, cryogenic boxes, and cryogenic vials, with more to come) are designed with to be compatible with standard-size equipment and to be suitable for the storage of many types of samples.

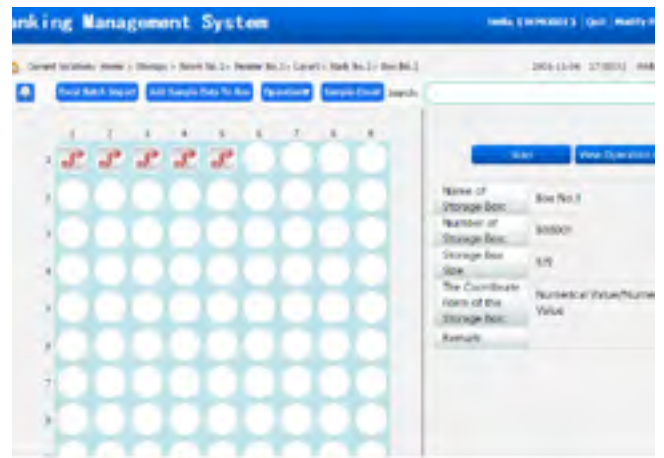

2. The Crown visual interface displays a visual representation of every level of a lab's sample storage from freezers to individual samples, allowing users to review their sample storage status at a glance.



3. Icons and templates can be customized to suit each lab's needs, and custom images can be uploaded for use as icons.

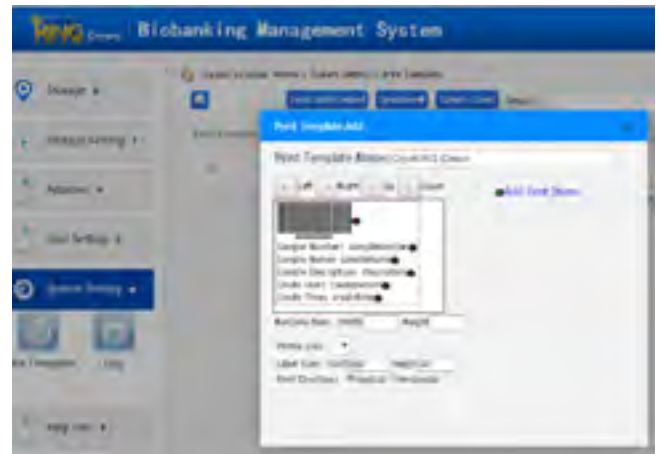

4. Transition seamlessly from your previous system by importing your data into the Crown system using Excel or CSV files.

# -164°C Ecryo Freezer



## Features

### Control System

- Microprocessor-based temperature controller, -120°C ~-164°C adjustable, digital temperature display
- Audible and visual alarm: High or low temperature alarm, Power failure alarm, Low battery alarm, Door open alarm, Filter blocking alarm, System failure alarm
- Keyboard lock and password protected configuration page, delayed start and safe stop interval between restart and being terminated
- With temperature recorder, 72 hour back up battery for recorder and controller work

### Structure Design

- Stainless steel interior, outer is painted steel panel, 4 units casters for easy handling
- Rotatable assistant door handle, top door with key lock
- Two-times foaming technology, 155mm extra thickness foaming insulation
- Optional: chart recorder, CO<sub>2</sub> back up system, storage racks/boxes, remote alarm system

### Refrigeration System

- Imported famous brand compressor, quick freezing functions, with lower noise
- Unique refrigeration circulation and unipolar compressor oil-lubricated technology
- Use China Patent technology of mixture refrigerant. For specially Single stage refrigeration
- VIP board install, for good heat preservation

Model	Capacity(L)	Input Power	Temperature	External Size (WxDxH) mm	Internal Size (WxDxH) mm	Weight (N.t)
CKF-ZW128	128	9200	-120--164°C	1510x985x1120	510x460x540	245



CKF-UL508

CKF-UL540

## Features

### Control System

- Double microprocessor-based temperature controller,  $-40^{\circ}\text{C}$  ~  $-86^{\circ}\text{C}$  can be set freely and control each room separately, controlling precision is  $1^{\circ}\text{C}$ , digital temperature display
- Keyboard lock and password protected configuration page, delayed start and safe stop interval between restart and being terminated
- Audible and visual alarm: High or low temperature alarm, Power failure alarm, Low battery alarm, Door open alarm, Filter blocking alarm, System failure alarm.

### Structure Design

- Double doors for up and down rooms, Inside chamber with inner insulation door, and double silicon gasket seal
- Stainless steel interior, outer is painted steel panel, 4 units Casters for easy handling
- Front opening lockable door with full height handle, with vacuum release port
- Two-times foaming technology. 130mm foaming insulation, with VIP insulation board
- With temperature recorder, record 7 days data. 72 hour back up battery for recorder and controller work
- Optional: Chart recorder,  $\text{CO}_2$  back up system, storage racks/boxes, remote alarm system

### Refrigeration System

- Double cooling system to support different rooms separately and independently. If one system damage, another one can work normally
- Imported famous compressor ( 2 sets ) and EBM fan motor
- China Patent technology of mixture refrigerant, specially single stage refrigeration design

Model	Capacity(L)	Input Power	External Size (WxDxH) mm	Internal Size (WxDxH) mm	Weight (N.t)	Racks (5*5)	Max Vials (1.5ml)
CKF-UL508	508	2000W	1200x897x1999	Up: 880x504x570 Down: 880x504x514	320KG	22	26400
CKF-UL540	540	1800W	918x840x1984	695x600x1330	340KG	24	28800

# -86°C Ultra-low Temperature Freezers - New II Upgrades



CKF-UL218/398/528/678/778/858/1008

CKF-UL100

## Features

### Control System

- 7inch touch screen controller,  $-40^{\circ}\text{C}$  ~  $-86^{\circ}\text{C}$  adjustable, controlling precision is  $1^{\circ}\text{C}$
- Keyboard lock and password protected configuration page, delayed start and safe stop interval between restart and being terminated
- Audible and visual alarm: High or low temperature alarm, Power failure alarm, Low battery alarm, Door open alarm, Filter blocking alarm, System failure alarm

### Structure Design

- Stainless steel interior, outer is painted steel panel, 4 units casters for easy handling
- Front opening lockable door with new ingenious handle, easy open and close.

#### Vacuum release port

- Adjustable stainless steel shelves with inner insulation doors, double silicon gasket seal
- Two-times foaming technology. 120mm foaming insulation, with VIP insulation board
- With USB store functions
- Optional: Chart recorder,  $\text{CO}_2$  back up system, storage racks/boxes, remote alarm system

### Refrigeration System

- Imported famous brand compressor, lower the noise and reduce the power consumption
- Fan electromotor with internationally famous of Germany EBM
- China Patent technology of mixture refrigerant, specially single stage refrigeration design

### Freezer sides



# Ultra-low Temperature Liquid Nitrogen Tanks-Biobank Series



CKD-V035S013



CKD-V045S013



CKD-V180S013

## Features

- Available for vapor and liquid phase
- Available in different capacities
- Small footprint and large capacity to reduce storage cost
- Stable temperature control
- Advanced temperature monitoring system, liquid level monitoring system and alarming system
- Automatic liquid nitrogen filling system
- The microprocessor system keeps data and information forever
- Demist button
- Special design for convenient operation
- Lockable lid to ensure the safety of samples
- Integral foldable steps and operation platform
- CE certified

Cat #	Capacity (L)	Neck Diameter (mm)	Inner Usable Height (mm)	Outer Diameter (mm)	Height (mm)	Maxi. Storage Capacity of 2ml Cryogenic Vials	Max. Blood Bag Holding Capacity	Maximum Load
CKD-V035S013	350	326	600	875	1326	13000	1296	502
CKD-V045S013	460	326	828	875	1558	18200	1728	649
CKD-V055S013	587	445	600	1104	1321	26000	2376	802
CKD-V075S013	783	445	828	1104	1591	36400	3168	1005
CKD-V085S013	890	465	773	1190	1559	42900	3360	1160
CKD-V100S013	1014	465	900	1190	1704	49500	4320	1314
CKD-V130S013	1340	635	620	1565	1398	58500	4716	1934
CKD-V160S013	1660	635	791	1565	1589	76050	5502	2255
CKD-V180S013	1880	635	900	1565	1883	87750	7074	2504
CKD-V180S014	1880	635	900	1565	1883	94875	7758	2504
CKD-V190S014	1946	635	830	1685	1509	105700	8432	2432
CKD-V200S014	2041	635	880	1685	1559	113250	8432	2529
CKD-V210S014	2156	635	940	1685	1619	120800	9486	2642
CKD-V220S014	2270	635	1000	1685	1697	128350	10540	2754

# Ultra-low Temperature Liquid Nitrogen Tanks-Laboratory Series



## Features

- Made of durable aluminum alloy
- Racks and boxes are available
- Large capacity and low energy consumption
- Locked-lid switch, liquid level monitoring system and carrying cart are available
- CE certified
- Vacuum warranty: 5 years
- Designed for long-term storage
- Labeled racks and boxes for sample identification and orientation
- Liquid level monitoring system is optional and it will send out sound and light for alarm when the liquid reaches low level



Cat #	Geometric Capacity (L)	Neck Diameter (mm)	Number of Cryogenic Vials	Static Evaporation Loss Rate (LD)	Static Holding Time (D)
CKS-L010Q125	10	125	100	0.42	24
CKS-L015Q125	15	125	75	0.36	42
CKS-L020Q125	20	125	100	0.37	54
CKS-L025Q125	25	125	125	0.37	67
CKS-L030Q125	30	125	600	0.33	90
CKS-L035Q125	35	125	750	0.36	97
CKS-L047Q127	47	127	750	0.36	130
CKS-L050Q125	50	125	900	0.43	115
CKS-L065Q216	65	216	2400	0.78	83
CKS-L095Q216	95	216	3000	0.97	98
CKS-L115Q216	115	216	3600	0.94	122
CKS-L145Q216	145	216	4800	0.96	146
CKS-L175Q216	175	216	6000	0.95	184



Portable Dewar Series

## Features

- Made of durable aluminum alloy
- Protective holding bag
- Low evaporation
- Numerical canisters for orientation
- Lockable-lid switch is available
- CE certified
- Vacuum warranty: 5 years



Static Storage Series

## Features

- Made of durable aluminum alloy
- Low evaporation
- Numerical canisters for orientation
- Large capacity for straws
- Canes are available
- Lockable-lid switch is optional
- Liquid level monitoring system is optional
- Carrying cart is optional
- Liquid nitrogen pump is optional
- CE certified
- Vacuum warranty: 5 years

# Cell Culture Series

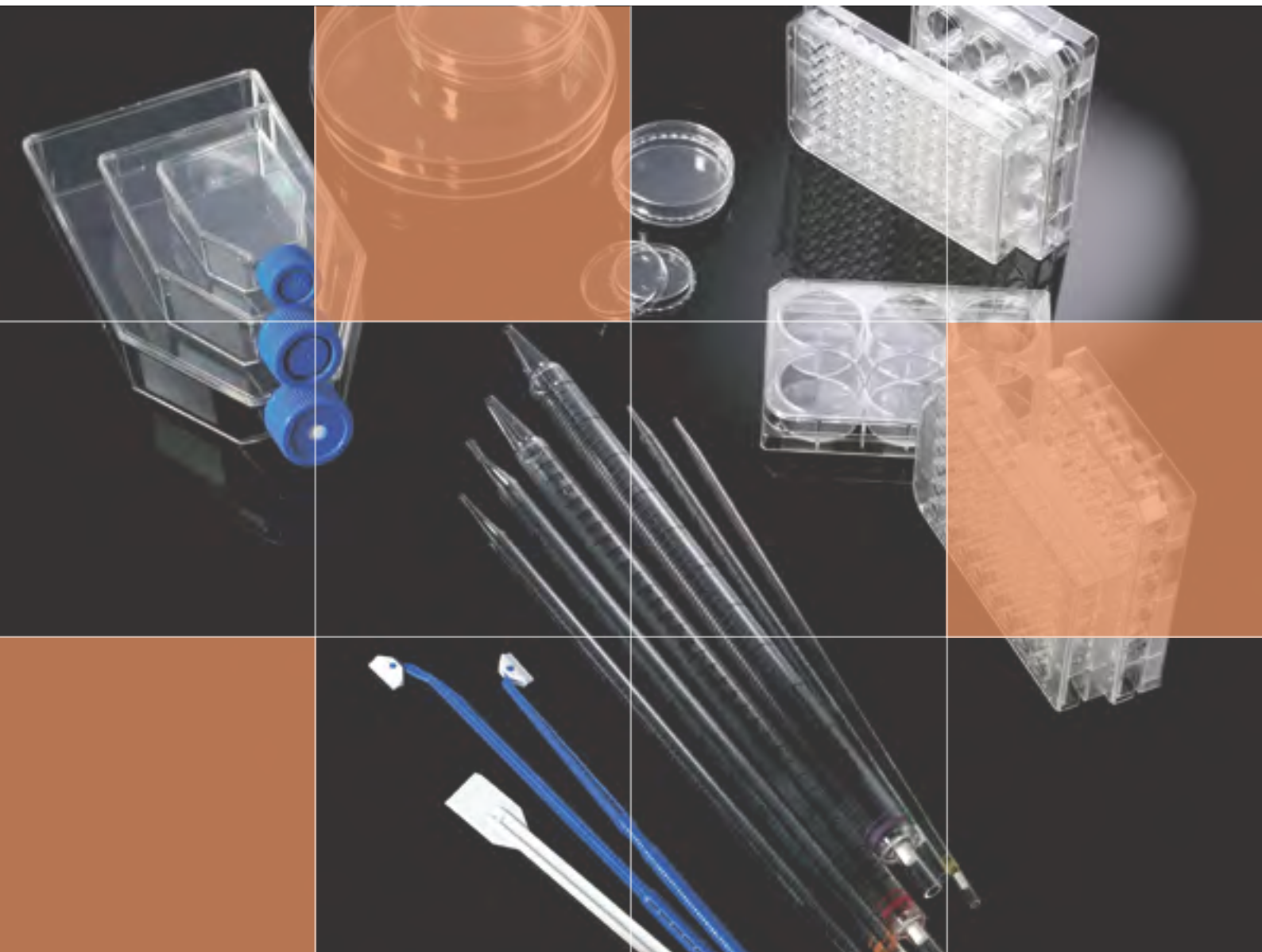

Cell culture involves sampling cells from an organism, placing these cells in an in vitro environment, and observing the growth, reproduction, aging or other processes of the cells. Cell culture has become an important practice in life science research, and plays a central role in the development of the biotechnology industry.

The Biologix Cell Culture Series offers a range of safe and reliable basic supplies for cell transfer, filtering, and other applications.





## Features

- Made of high quality medical grade polystyrene
- Available flask sizes include surface areas of 25 cm<sup>2</sup>, 75 cm<sup>2</sup>, or 175 cm<sup>2</sup>
- Plug cap and filter cap options available for all flask sizes
- Plug caps completely isolate the culture from the outside environment
- Filter caps prevent cross-contamination while meeting the requirements for gas exchange
- Short, wide, angled neck design for easy access
- Gamma radiation sterilized
- Non-pyrogenic, non-cytotoxic
- DNase & RNase free, human DNA free

Suitable for open culture conditions, effectively preventing cross-contamination while meeting the requirements for gas exchange in cell and tissue culture

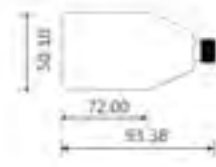
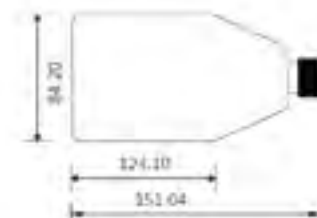
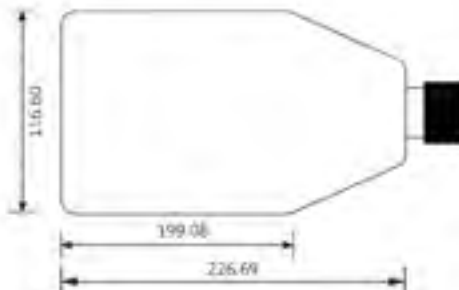

Dimensions = mm

Cat #	Cap Type	Culture Area	Working Volume	Total Volume	Surface Treatment	Sterile	Unit
07-8025	Filter	25cm <sup>2</sup>	7ml	60 ml	Yes	Yes	5 /Bag, 40 Bags/Case
07-8075	Filter	75cm <sup>2</sup>	25ml	250ml	Yes	Yes	5 /Bag, 20 Bags/Case
07-8175	Filter	175cm <sup>2</sup>	50ml	650ml	Yes	Yes	5 /Bag, 8 Bags/Case
07-9025	Plug	25cm <sup>2</sup>	7ml	60ml	Yes	Yes	5 /Bag, 40 Bags/Case
07-9075	Plug	75cm <sup>2</sup>	25ml	250ml	Yes	Yes	5 /Bag, 20 Bags/Case
07-9175	Plug	175cm <sup>2</sup>	50ml	650ml	Yes	Yes	5 /Bag, 8 Bags/Case

# Cell Culture Dishes

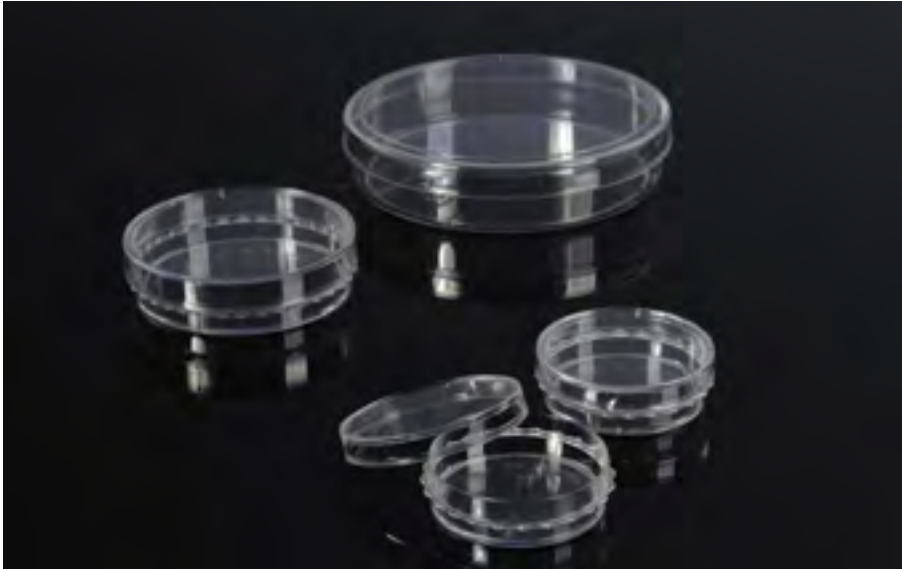

## Features

- Made of high quality medical grade polystyrene
- Lid design promotes effective gas exchange
- External grip for easier handling (07-3035 and 07-3060)
- Raised edges for convenient stacking
- Vacuum plasma surface treatment ensures excellent cell adhesion
- Smooth, transparent materials facilitate observation of cells through a microscope
- Gamma radiation sterilized
- Non-pyrogenic, non-cytotoxic
- DNase & RNase free, human DNA free

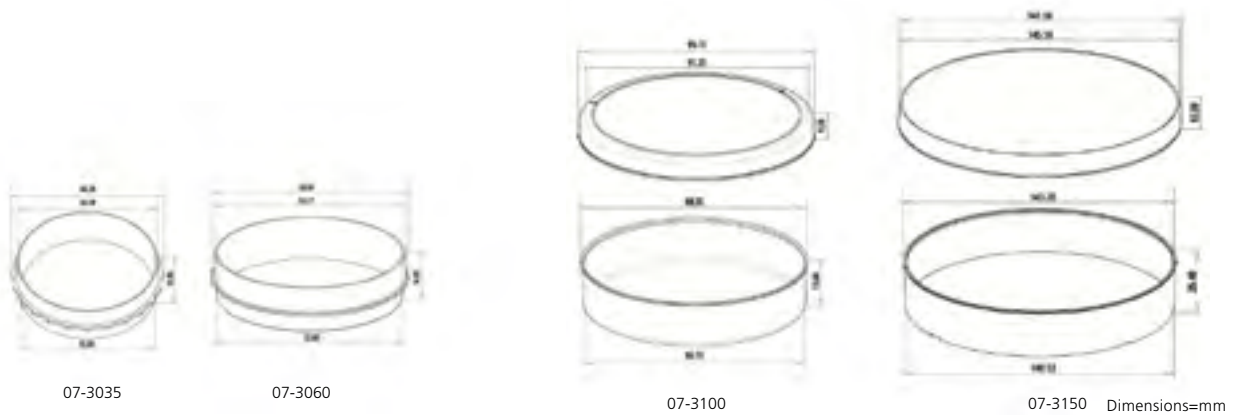

Cat #	Dish style DxH(mm)	Internal Dimensions D x H (mm)	Culture Area	Working Volume	External Grip	Sterile	Unit
07-3035	35.00 x 10.00	34.30 x 9.30	9.40cm <sup>2</sup>	3.00ml	Yes	Yes	10 /Bag, 50 Bags/Case
07-3060	60.00 x 15.00	52.80 x 12.80	21.50cm <sup>2</sup>	5.00ml	Yes	Yes	10 /Bag, 50 Bags/Case
07-3100	90.00 x 20.00	86.26 x 17.70	57.50cm <sup>2</sup>	12.50ml	No	Yes	10 /Bag, 20 Bags/Case
07-3150	150.00 x 25.00	140.20 x 23.30	148.00cm <sup>2</sup>	35.00ml	No	Yes	10 /Bag, 12 Bags/Case

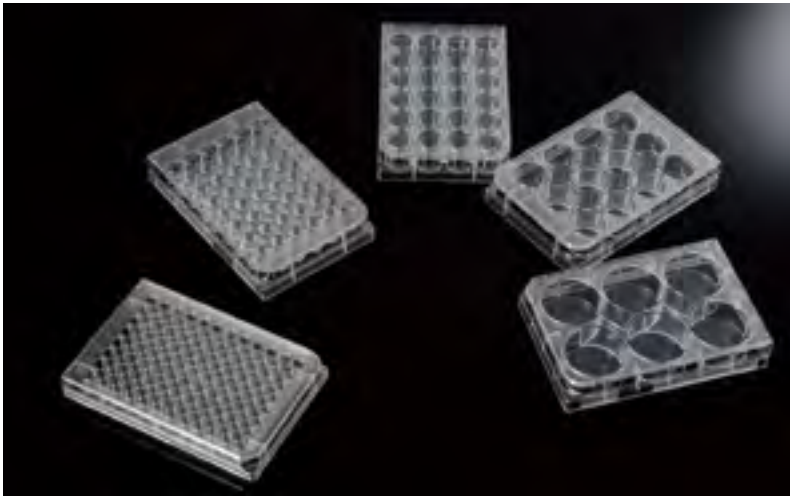

## Features

- Constructed of prime virgin polystyrene
- Plate cover design minimizes the risk of cross contamination
- Thin-walled well bottoms increase thermal consistency, reducing the edge effect
- Flat well bottoms provide excellent clarity for microscopic examination of samples
- Gamma radiation sterilized
- Non-pyrogenic, non-cytotoxic
- DNase & RNase free, human DNA free

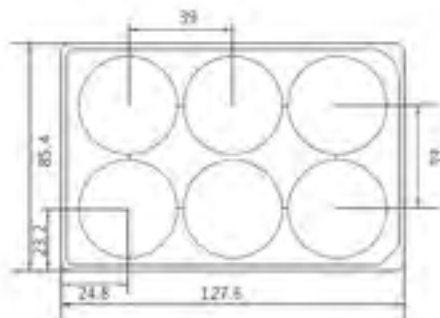

Dimensions = mm

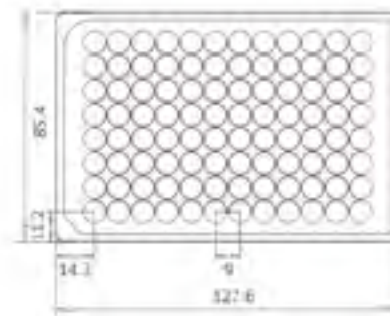

Cat #	Wells	External Dimensions W x L x H (mm)	Well Dimensions D x H (mm)	Culture Area	Working Volume	Sterile	Unit
07-6006	6-well	85.40 x 127.60 x 20.20	35.00 x 17.50	9.6cm <sup>2</sup>	3ml	Yes	1 /Bag, 50 Bags/Case
07-6012	12-well	85.40 x 127.60 x 20.20	21.90 x 17.50	3.8cm <sup>2</sup>	2ml	Yes	1 /Bag, 50 Bags/Case
07-6024	24-well	85.40 x 127.60 x 20.20	15.50 x 17.50	1.9cm <sup>2</sup>	1ml	Yes	1 /Bag, 50 Bags/Case
07-6048	48-well	85.40 x 127.60 x 20.20	9.75 x 17.50	0.75cm <sup>2</sup>	0.5ml	Yes	1 /Bag, 50 Bags/Case
07-6096	96-well	85.40 x 127.60 x 14.40	6.50 x 10.80	0.33cm <sup>2</sup>	0.2ml	Yes	1 /Bag, 50 Bags/Case

# Serological Pipettes

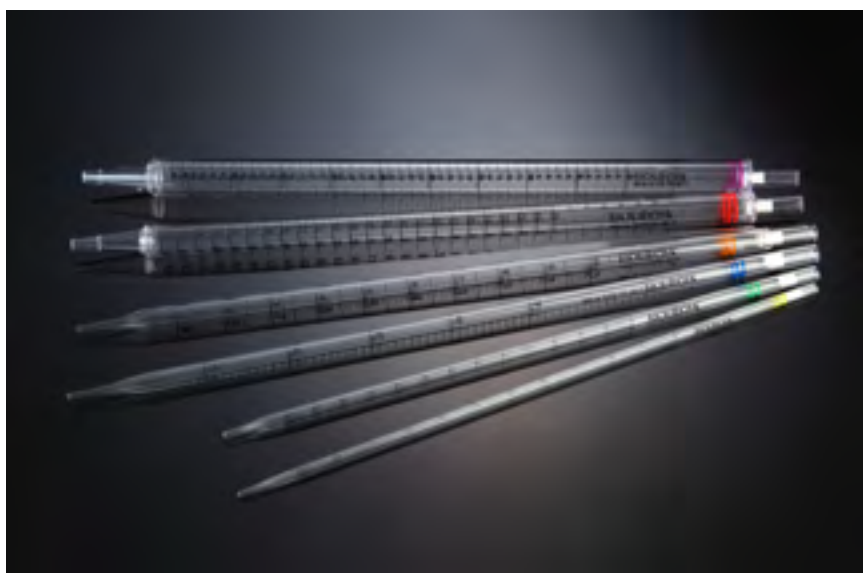

## Features

- Constructed of highly transparent prime virgin polystyrene
- Available in 1ml, 2ml, 5ml, 10ml, 25ml, 50ml volumes
- Each volume labeled with a different color for ease of use
- Ascending and descending graduations
- Filter at the top of each pipette prevents damage to pipettors
- Electron beam sterilized
- Non-pyrogenic, non-cytotoxic
- DNase & RNase free, human DNA free

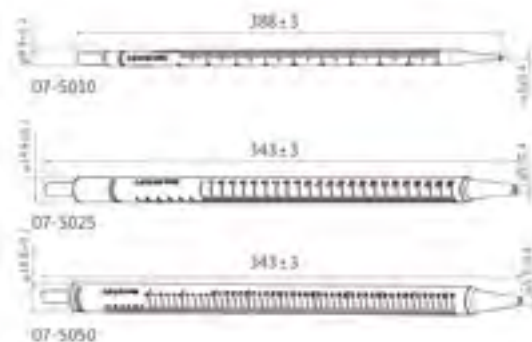
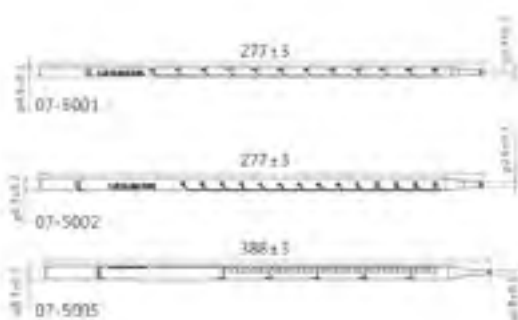

Dimensions = mm

Cat #	Working Volume	Color	Sterile	Unit
07-5001	1.00ml	Yellow	Yes	1 /Bag, 200 Bags/Pack, 4 Packs/Case
07-5002	2.00ml	Green	Yes	1 /Bag, 150 Bags/Pack, 4 Packs/Case
07-5005	5.00ml	Blue	Yes	1 /Bag, 100 Bags/Pack, 4 Packs/Case
07-5010	10.00ml	Orange	Yes	1 /Bag, 100 Bags/Pack, 4 Packs/Case
07-5025	25.00ml	Red	Yes	1 /Bag, 50 Bags/Pack, 4 Packs/Case
07-5050	50.00ml	Purple	Yes	1 /Bag, 40 Bags/Pack, 4 Packs/Case

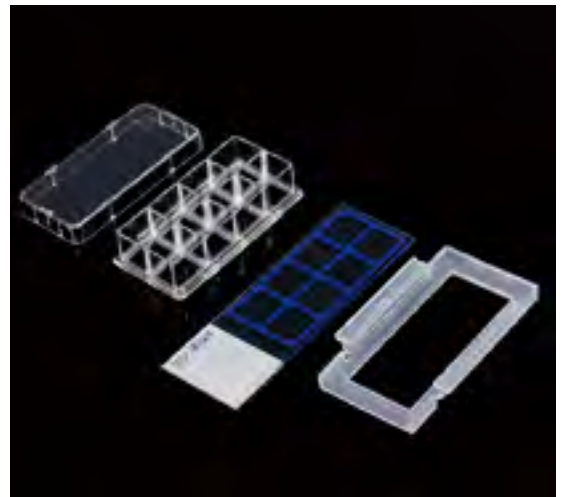
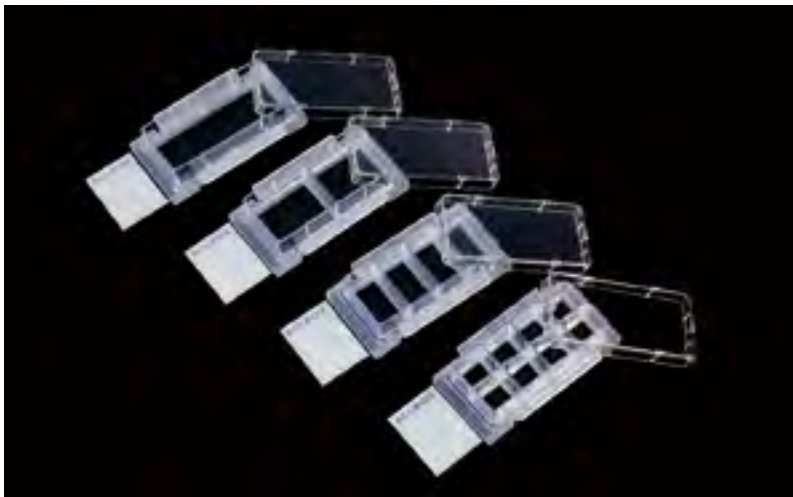

## Features

- Easy-to-open, highly transparent slide chambers
- Chamber numbering for convenient sample identification
- Polystyrene chamber piece available with 1, 2, 4, or 8 wells
- Packing trays can be used as incubation racks in CO<sub>2</sub> incubators
- Slide and chamber apparatus can be easily disassembled without damaging samples

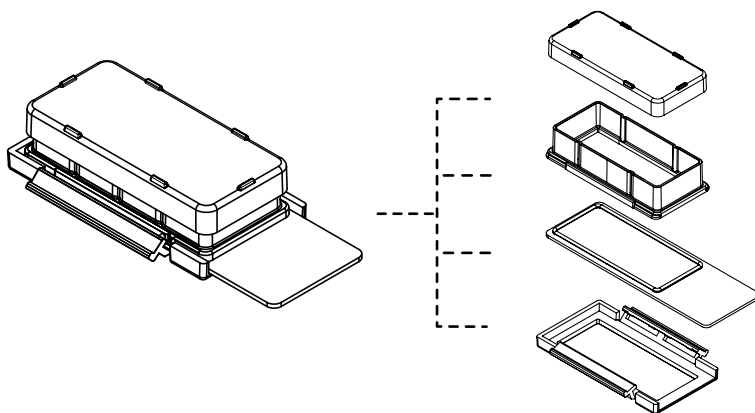

Easy-to-open,  
highly transparent  
slide chambers

Cat #	Material Chamber/Slide/Holder	Wells	Color	Growth Area	Working	Sterile	Unit
07-2101	PS /Glass/PP	1-well	Clear	9.40cm <sup>2</sup>	2.50-5.50ml	Yes	6 /Pack, 2 Packs/Case
07-2102	PS /Glass/PP	2-well	Clear	4.55cm <sup>2</sup>	1.20-2.50ml	Yes	6 /Pack, 2 Packs/Case
07-2104	PS /Glass/PP	4-well	Clear	2.13cm <sup>2</sup>	0.50-1.30ml	Yes	6 /Pack, 2 Packs/Case
07-2108	PS /Glass/PP	8-well	Clear	0.98cm <sup>2</sup>	0.20-0.60ml	Yes	6 /Pack, 2 Packs/Case

# Cell Strainers

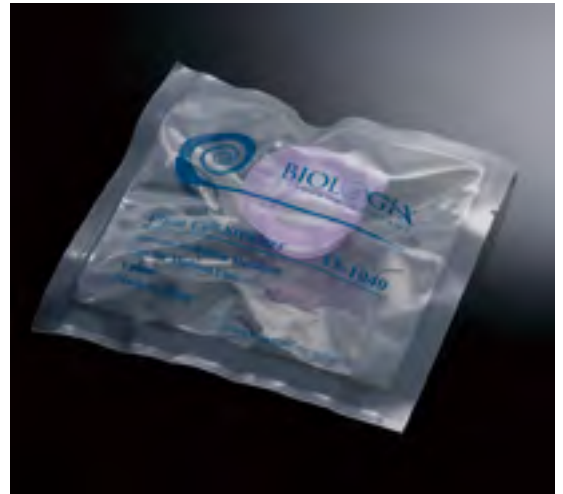

## Features

- Made of sturdy polypropylene and strong nylon mesh
- Three different pore sizes available: 40µm, 70µm, or 100µm
- Strainers are color-coded according to pore size for convenience
- Fits perfectly into Biologix 50ml Centrifuge Tubes
- Gamma radiation sterilized, non-pyrogenic

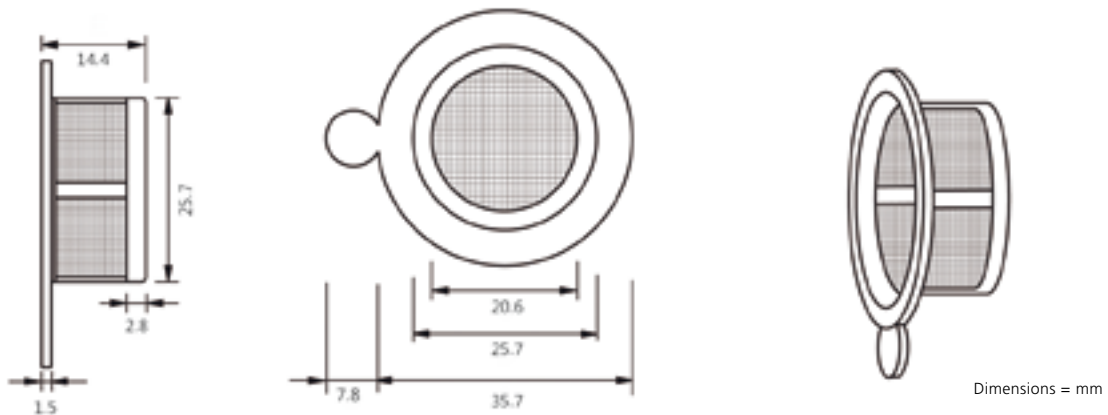

Cat #	Size	Color	Sterile	Package	Unit
15-1040	40µm	Purple	Yes	Individual	1 /Bag, 100 Bags/Case
15-1070	70µm	Orange	Yes	Individual	1 /Bag, 100 Bags/Case
15-1100	100µm	Green	Yes	Individual	1 /Bag, 100 Bags/Case

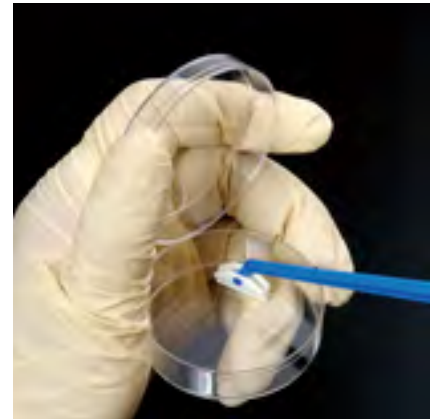

## Features

### Cell Scrapers

- Made of polyethylene
- Available in two sizes: 18cm or 25cm in length,
- Pivoting blade makes precise cutting and scraping movements
- Gamma radiation sterilized, non-pyrogenic

### Cell Lifters

- Made of polyethylene
- One-piece design and chiseled blade provide improved control while minimizing damage to cells
- Gamma radiation sterilized, non-pyrogenic

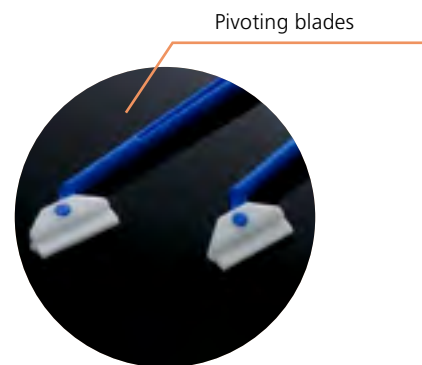
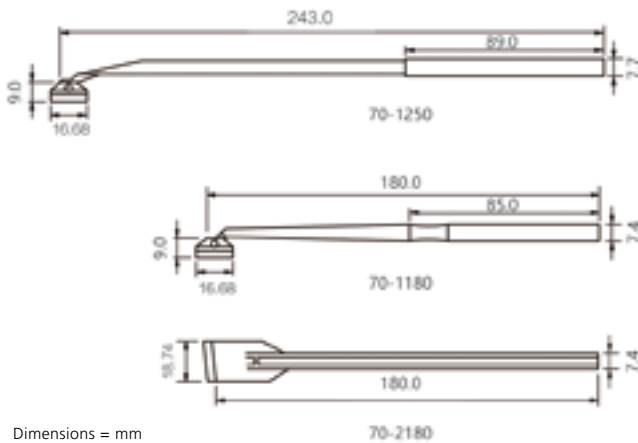

Cat #	Name	Handle Length	Sterile	Package	Unit
70-2180	Cell Lifter	18cm	Yes	Individual	1 /Bag, 100 Bags/Case
70-1180	Cell Scraper	18cm	Yes	Individual	1 /Bag, 100 Bags/Case
70-1250	Cell Scraper	24.3cm	Yes	Individual	1 /Bag, 200 Bags/Case

# PCR Series

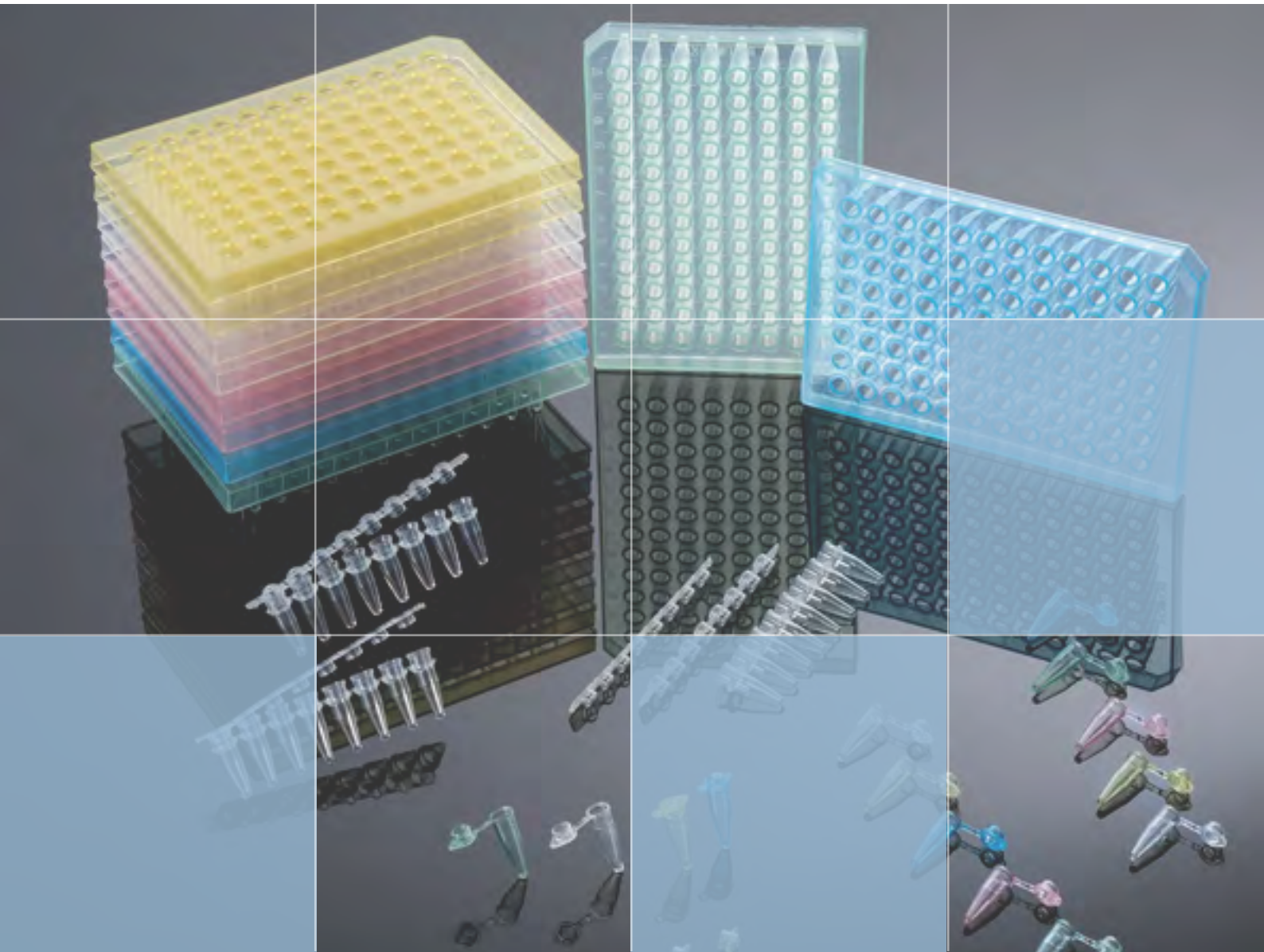

PCR (polymerase chain reaction) is a technique used in molecular biology to amplify a segment of DNA, and is commonly used in both clinical and research laboratories for many applications, including DNA sequencing, diagnosis of hereditary diseases, and more. The Biologix PCR Series includes a variety of PCR tubes and plates suitable for standard PCR experiments.





## Features

- Made of high quality medical grade polypropylene
- Ultra thin-wall tubes provide faster heating and cooling
- High degree of transparency allows for easy observation of samples
- Available with domed caps or flat caps
- Domed caps ensure efficient heat transfer
- Flat caps are ideal for Real-Time PCR (qPCR)
- Unique cap design prevents opening during cycling and incubation stages
- DNase, RNase, and endotoxin free

## Specifications

- Fits most standard thermocyclers
- Can withstand centrifugation of up to 6,000 RCF
- \* Assorted colors for PCR tubes should be ordered separately

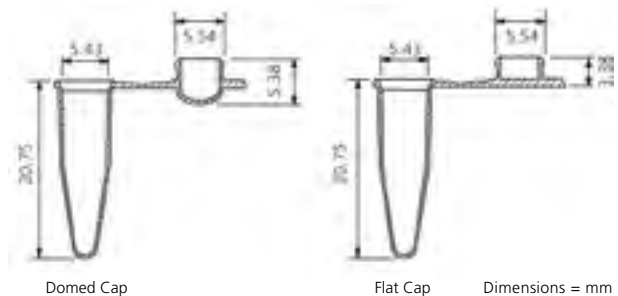

Cat #	Volume	Color	Cap	Sterile	Unit
60-0082	0.2ml	Clear	Flat-top	No	1,000 /Bag/Pack, 10 Packs/Case
60-0182	0.2ml	Pink	Flat-top	No	1,000 /Bag/Pack, 10 Packs/Case
60-0282	0.2ml	Green	Flat-top	No	1,000 /Bag/Pack, 10 Packs/Case
60-0382	0.2ml	Blue	Flat-top	No	1,000 /Bag/Pack, 10 Packs/Case
60-0482	0.2ml	Yellow	Flat-top	No	1,000 /Bag/Pack, 10 Packs/Case
60-0002	0.2ml	Clear	Dome-shaped	No	1,000 /Bag/Pack, 10 Packs/Case
60-0102	0.2ml	Pink	Dome-shaped	No	1,000 /Bag/Pack, 10 Packs/Case
60-0202	0.2ml	Green	Dome-shaped	No	1,000 /Bag/Pack, 10 Packs/Case
60-0302	0.2ml	Blue	Dome-shaped	No	1,000 /Bag/Pack, 10 Packs/Case
60-0402	0.2m	Yellow	Dome-shaped	No	1,000 /Bag/Pack, 10 Packs/Case

# 8-Strip PCR Tubes



## Features

- Made of high quality medical grade polypropylene
- Ultra thin-wall tubes provide faster heating and cooling
- High degree of transparency allows for easy observation of samples
- Available with domed caps or flat caps
- Domed caps ensure efficient heat transfer
- Flat caps are ideal for Real-Time PCR (qPCR)
- Unique cap design prevents opening during cycling and incubation stages

## Specifications

- Fits most standard thermocyclers
  - Can withstand centrifugation of up to 6,000 RCF
  - Packaged in resealable bags
- \* Assorted colors for 8-Strip PCR tubes should be ordered separately

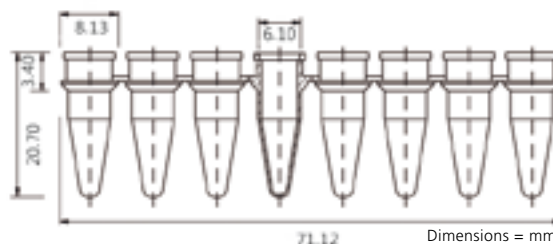

Cat#	Volume	Color	Cap Type	Sterile	Unit
60-0088	0.2ml	Clear	Flat	No	125 Strip Tubes+125 Strip Caps/Bag/Pack, 10 Packs/Case
60-0188	0.2ml	Pink	Flat	No	125 Strip Tubes+125 Strip Caps/Bag/Pack, 10 Packs/Case
60-0288	0.2ml	Green	Flat	No	125 Strip Tubes+125 Strip Caps/Bag/Pack, 10 Packs/Case
60-0388	0.2ml	Blue	Flat	No	125 Strip Tubes+125 Strip Caps/Bag/Pack, 10 Packs/Case
60-0488	0.2ml	Yellow	Flat	No	125 Strip Tubes+125 Strip Caps/Bag/Pack, 10 Packs/Case
60-0008	0.2ml	Clear	Domed	No	125 Strip Tubes+125 Strip Caps/Bag/Pack, 10 Packs/Case
60-0108	0.2ml	Pink	Domed	No	125 Strip Tubes+125 Strip Caps/Bag/Pack, 10 Packs/Case
60-0208	0.2ml	Green	Domed	No	125 Strip Tubes+125 Strip Caps/Bag/Pack, 10 Packs/Case
60-0308	0.2ml	Blue	Domed	No	125 Strip Tubes+125 Strip Caps/Bag/Pack, 10 Packs/Case
60-0408	0.2ml	Yellow	Domed	No	125 Strip Tubes+125 Strip Caps/Bag/Pack, 10 Packs/Case



## Features

- Made of high quality medical grade polypropylene
- Ultra-thin tube walls with uniform thickness for accelerated heat transfer, shorter cycle times, and more consistent results
- Alphanumeric well labeling for convenient identification
- DNase, RNase, and endotoxin free

## Specifications

- Fits most standard thermocyclers
- Can withstand centrifugation of up to 6,000 RCF
- \* Assorted colors for PCR Plates should be ordered separately



Half-skirted plates are easy to insert and remove

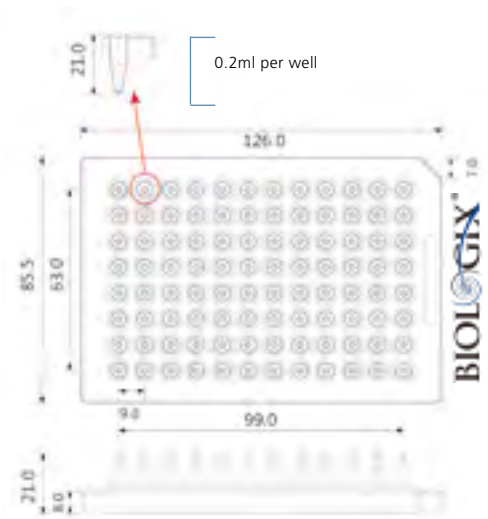

Dimensions = mm

Cat #	Well	Skirt	Color	Sterile	Unit
60-0056	96-well	Half-Skirted	Clear	No	5 /Bag, 5 Bags /Pack, 4 Packs/Case
60-0156	96-well	Half-Skirted	Pink	No	5 /Bag, 5 Bags /Pack, 4 Packs/Case
60-0256	96-well	Half-Skirted	Green	No	5 /Bag, 5 Bags /Pack, 4 Packs/Case
60-0356	96-well	Half-Skirted	Blue	No	5 /Bag, 5 Bags /Pack, 4 Packs/Case
60-0456	96-well	Half-Skirted	Yellow	No	5 /Bag, 5 Bags /Pack, 4 Packs/Case

# PCR Plate Compatibility

## Biologix Plates ▶

60-0056  
(Half-Skirted)



Brand	Model	
<b>Real Time PCR Thermal Cyclers</b>		
Applied Biosystems	7000	✓
	7300	✓
	7500	✓
	7700	✓
	7900HT	✓
	StepOne	
BioRad	iCycler	✓
	MyiQ	
	iQ5	✓
Eppendorf	MasterCycler ep Realplex	
MJ Research	Opticon	
	Opticon 2	
	Chromo 4	
	MX-4000	
	MX-3000	
Techne	Quantica	
<b>PCR Thermal Cyclers</b>		
Applied Biosystems	Veriti	✓
	9600	✓
	9700	✓
	7800FAST	
	2720	✓
Biometra	Uno	✓
	Uno II	✓
	T1 Thermal Cycler	✓
	Tgrasient	✓
	Trobot	✓
BioRad	iCycler	✓
	MyCycler	✓
Corbett Research	PalmCycler 96	✓
	PalmCycler 384	
Eppendorf	Mastercycler	✓
	Mastercycler ep	✓
	Mastercycler M384	
Flexi	Gene	✓
	Genius	✓

## Biologix Plates ▶

60-0056  
(Half-Skirted)



Brand	Model	
Ericom	Single Block	✓
	Twin Block	✓
	Deltacycler I	✓
ThermoHybaid	PCR Sprint	✓
	PCR Express	✓
	Multiblock System	✓
	Touchdown	✓
	Omnigene	✓
	Omn-E	✓
	pxe	✓
	px2	✓
	MJ Research	PTC-100
PTC-200		✓
PTC-225 Tetrad		✓
Dyad/Disciple		✓
MWG	Primus 96	✓
	Primus 384	
Stratagene	Robocycler	
TaKaRa	TP240	
	TP3000	✓
Techne	Touchgene Gradient (TC512)	✓
	Genius (TC412)	✓
	Touchgene X	✓
<b>Sequencers</b>		
Applied Biosystems	3100	✓
	3130	✓
	3700	✓
	3730/3730x	✓

This chart is intended only as a general guide. Compatibility may vary based on your particular configuration and features. For further help with product selection, please contact us.

FOR TECHNICAL INFORMATION, VISIT [WWW.BIOLOGIXGROUP.COM](http://WWW.BIOLOGIXGROUP.COM)

# Microbiology Series

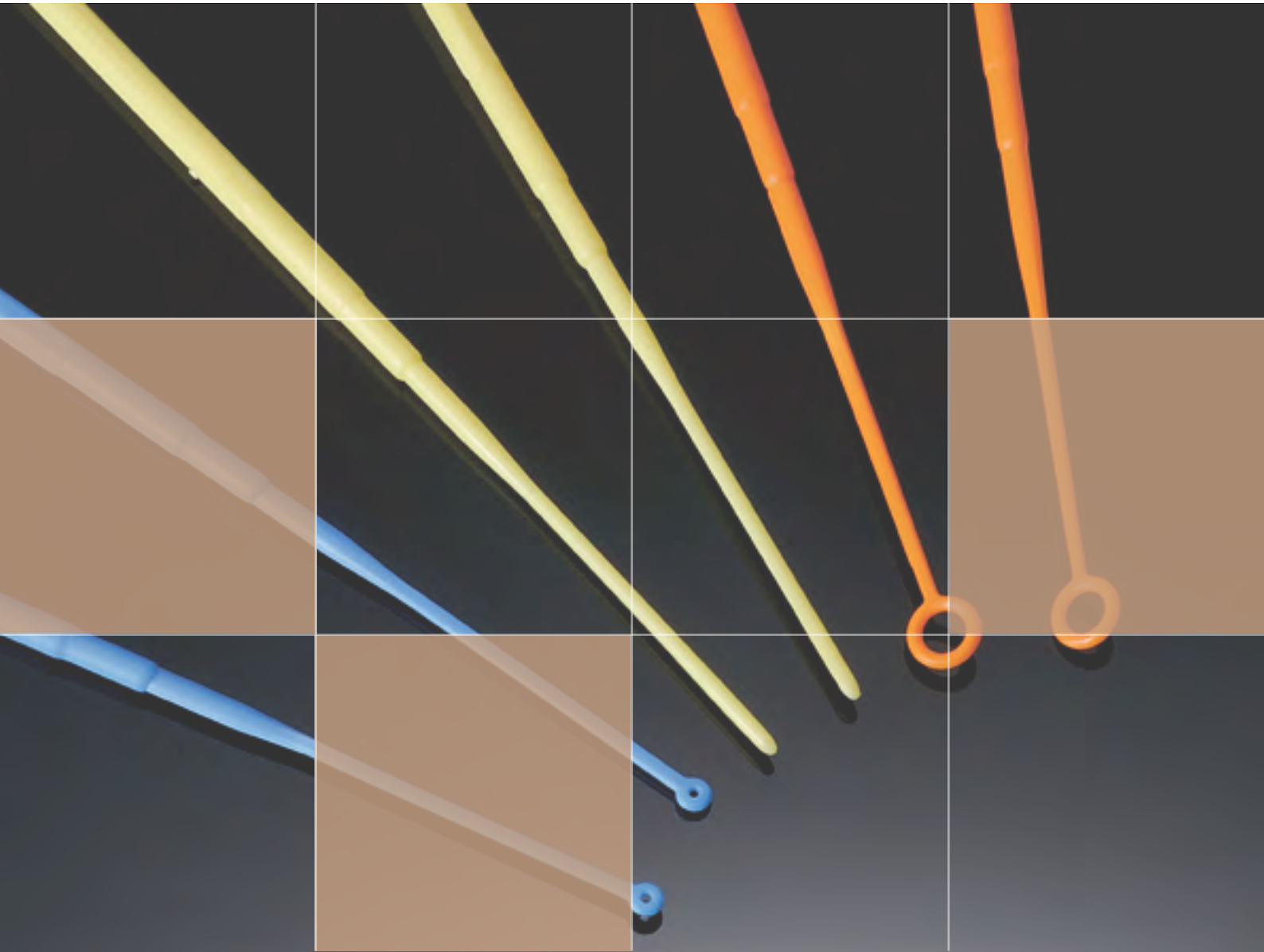

Microbiology is the study of microbial morphology, physiology, biochemistry, genetic variation, and more. It plays an important role in the study of genetic engineering, as well as disease control and prevention. Our Microbiology Series of products covers all your basic microbiology supply needs.

# Petri Dishes



## Features

- Made of medical grade polystyrene
- Highly transparent for microscopic analysis
- Three sizes available: 60mm, 90mm, or 150mm in diameter
- 66-1701 fit automatic systems
- Vented lid for better gas exchange
- Dishes are stackable

Vents for gas exchange

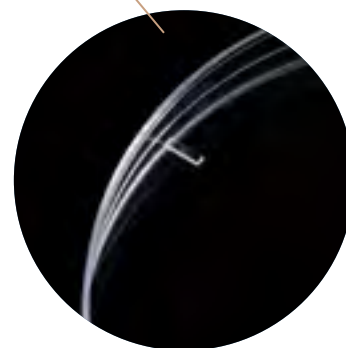

66-1560



66-1501

Dimensions = mm



Cat #	Size (mm)	Color	Sterile	Unit
66-1560	60x15	Clear	Yes	10 /Bag, 50 Bags/Case
66-1501	90x15	Clear	Yes	10 /Bag, 50 Bags/Case
66-1701	90x16	Clear	Yes	10 /Bag, 50 Bags/Case
66-1515	150x15	Clear	Yes	10 /Bag, 20 Bags/Case

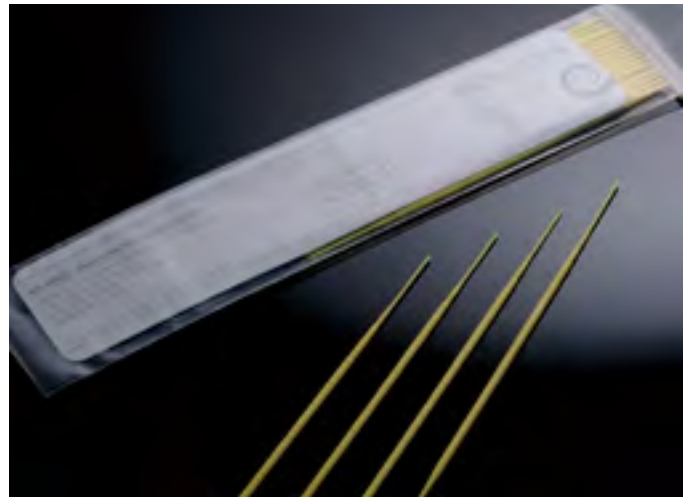

## Features

- Made of medical grade polystyrene
- Loops available in 1 $\mu$ L and 10 $\mu$ L sizes
- The opposite end of each loop can be used as a needle
- Needles are suitable for removal of single-colony specimens
- Gamma radiation sterilized, non-pyrogenic
- Packaged in resealable bags

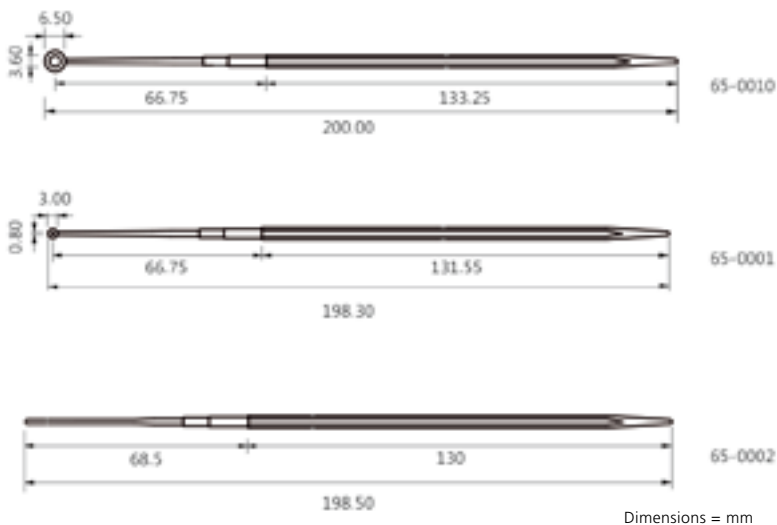

Can be used as needles



Cat #	Size	Description	Color	Sterile	Unit
65-0001	1 $\mu$ L	Loops	Blue	Yes	25 /Bag, 40 Bags/Case
65-0010	10 $\mu$ L	Loops	Orange	Yes	25 /Bag, 40 Bags/Case
65-0002	-	Needles	Yellow	Yes	25 /Bag, 40 Bags/Case

# Cell Spreaders

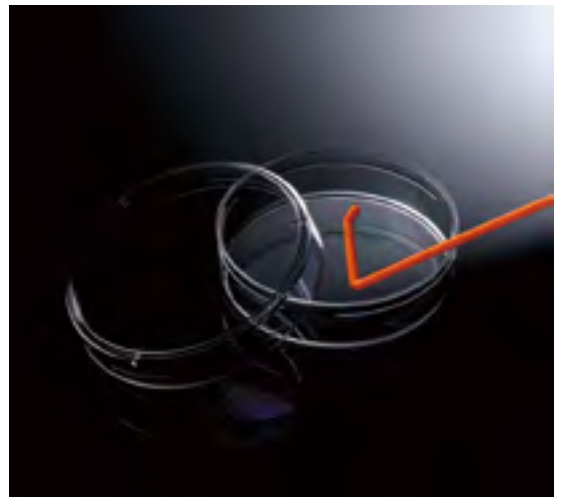
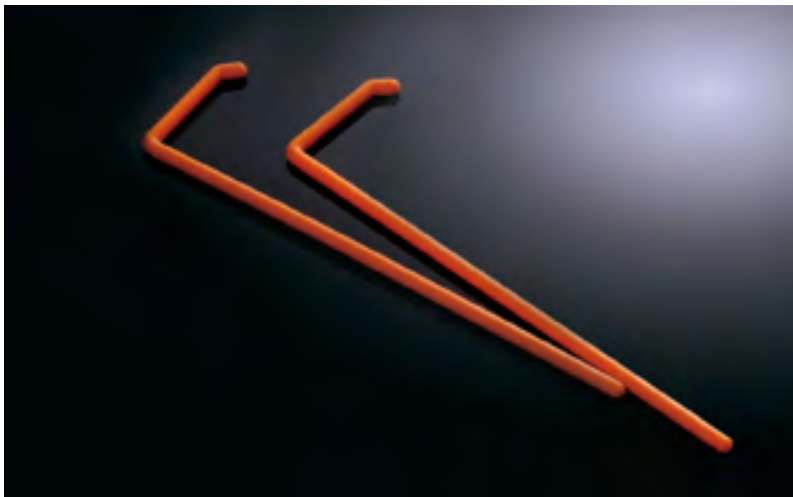

## Features

- Polystyrene
- Smooth surface quality and angled end reduce the risk of damaging the culture medium
- L-shape allows application on the entire Culture Dish or plate surface
- Two package options: individually wrapped (sterile), or 10 per bag (sterile, resealable)
- Gamma radiation sterilized



Individually plastic packaging



Zip-seal packaging

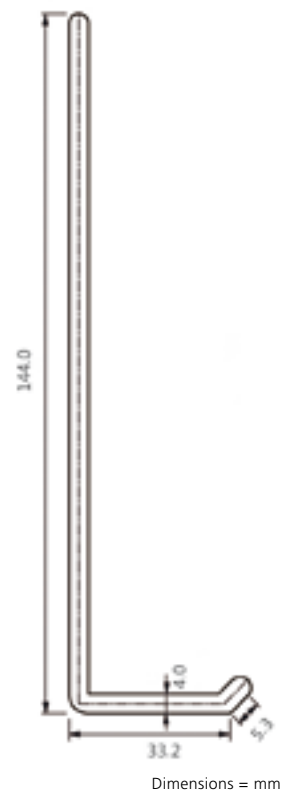

Cat #	Color	Sterile	Unit
65-1001	Orange	Yes	1 /Bag, 500 Bags/Case
65-1010	Orange	Yes	10 /Bag, 50 Bags/Case



# Drosophila Culture



Drosophila Culture is the culture of *Drosophila melanogaster* fruit flies, which is a common practice in the fields of genetics and developmental biology, due to the convenience of raising *D. melanogaster*, its rapid breeding rate, and the ease with which its morphology can be identified. Our Drosophila Culture Series includes vials, bottles, and foam plugs in bulk or tray packaging.

# Drosophila Vials



## Features

- Made of premium grade polystyrene
- Glass-like clarity for sample observation
- Disposable vials are a safe and cost-effective alternative to glass vials
- Narrow or wide vials available
- Both narrow and wide vials are available in bulk or tray packaging
- Tray packs are great for quick, effortless filling of vials

Your can put your logo here



51-0500



51-0800

Dimensions = mm



Cat #	Description	Dimensions (mm)	Sterile	Packaging	Unit
51-0500	Narrow	25 x 95	No	Bulk	25 /Bag, 20 Bags/Case
51-0501	Narrow	25 x 95	No	Tray	100 /Tray, 5 Trays/Case
51-0800	Wide	28.5 x 95	No	Bulk	25 /Bag, 20 Bags/Case
51-0801	Wide	28.5 x 95	No	Tray	100 /Tray, 5 Trays/Case

# Drosophila Bottles



## Features

- Made of clear polypropylene
- Autoclavable
- Transparent bottle with square bottom
- Firm, stiff neck for easier handling

Molded graduations

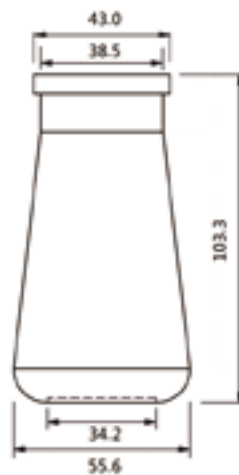

Dimensions = mm

Cat #	Sterile	Packaging	Unit
51-17720	No	Bulk	200 /Bag, 1 Bag/Case
51-17721	No	Tray	25 /Tray, 8 Trays/Case

# Drosophila Plugs



## Features

- Made of high density foam
- Causes minimal shedding and reduces evaporation
- Maintains tight fit after repeated use and removal
- Fits Biologix Drosophila vials and bottles



51-0505



51-0805



51-17725

Flat surface accepts can be marked



Cat #	Applied #	Fits	Sterile	Unit
51-0505	51-0500/0501	Narrow Drosophila Vials	No	100 /Bag, 10 Bags/Case
51-0805	51-0800/0801	Wide Drosophila Vials	No	100 /Bag, 10 Bags/Case
51-17725	51-17720/17721	Drosophila Bottles	No	100 /Bag, 10 Bags/Case

# Instruments



In addition to consumable lab supplies, laboratory instruments are also important tools for life science research. High-quality lab instruments can greatly improve research efficiency and ensure precise and accurate results. Biologix now supplies small laboratory instruments for a wide variety of applications, including liquid handling, mixing, PCR, centrifuging, electrophoresis, and more.



## dPette Digital Pipette

### Features

- Comprehensive range of liquid handling protocols
- Three aspiration/dispensing speeds
- Motor-drive with built-in error control
- Efficient lithium-ion rechargeable battery
- Autoclavable lower barrel



## Micro PettePlus Pipettes

### Features

- Convenient one-handed operation
- Fully autoclavable
- Compatible with most standard pipette tips



01-2306

## Pipette Stand (01-2306)

- Holds up to six single- or multi-channel pipettes

Cat #	Type	Channels	Volume Range ( $\mu\text{L}$ )	Tip Volume
01-241X	dPette Digital Pipette	1	0.5-10 $\mu\text{L}$	0.01 $\mu\text{L}$
01-242X	dPette Digital Pipette	1	5-50 $\mu\text{L}$	0.1 $\mu\text{L}$
01-243X	dPette Digital Pipette	1	30-300 $\mu\text{L}$	1 $\mu\text{L}$
01-244X	dPette Digital Pipette	1	100-1000 $\mu\text{L}$	5 $\mu\text{L}$
01-2101	MicroPette Plus Pipettes	1	0.5-10 $\mu\text{L}$	0.1 $\mu\text{L}$
01-2104	MicroPette Plus Pipettes	1	10-100 $\mu\text{L}$	1 $\mu\text{L}$
01-2102	MicroPette Plus Pipettes	1	20-200 $\mu\text{L}$	1 $\mu\text{L}$
01-2110	MicroPette Plus Pipettes	1	100-1000 $\mu\text{L}$	5 $\mu\text{L}$
01-2115	MicroPette Plus Pipettes	1	1000-5000 $\mu\text{L}$	50 $\mu\text{L}$
01-2122	MicroPette Plus Pipettes	1	2-20 $\mu\text{L}$	0.5 $\mu\text{L}$
01-2155	MicroPette Plus Pipettes	1	5-50 $\mu\text{L}$	0.5 $\mu\text{L}$
01-2801	MicroPette Plus Pipettes	8	0.5-10 $\mu\text{L}$	0.1 $\mu\text{L}$
01-2805	MicroPette Plus Pipettes	8	5-50 $\mu\text{L}$	0.5 $\mu\text{L}$
01-2830	MicroPette Plus Pipettes	8	50-300 $\mu\text{L}$	5 $\mu\text{L}$



## Levo ME Pipette Filler

### Features

- Ergonomic shape and intuitive operation
- Pressure-sensitive buttons: increasing pressure increases aspiration/dispensing speed
- Autoclavable hydrophobic filter prevents over-aspiration
- LED light indicates aspiration/dispensing, charging, and low battery

Cat #	Type	Aspiration Speeds	Dispensing Speeds	Battery Life	Compatible Pipette Types
01-221X	Levo ME	aspirates 25mL of water in < 7 seconds	gravity dispensing	8+ hours of intermittent use	glass or plastic pipettes (0.1-100mL), Pasteur pipettes



## Levo Plus Pipette Filler

### Features

- Eight aspiration and dispensing speeds
- LCD display shows speed settings and remaining battery life
- Efficient lithium-ion battery can last for up to 8 hours of intermittent use
- Integral, autoclavable silicone adapter suits use with 0.1-100 mL pipettes

Cat #	Type	Aspirate Speeds	Dispense Speeds	Battery Life	Compatible Pipette Types
01-220X	Levo Plus	25ml<5s(8 shift)	Motor (8 shift) / Gravity	8+ hours of intermittent use	glass or plastic pipettes (0.1-100mL), Pasteur pipettes



## SAFEVAC Vacuum Aspiration System

### Features

- Integrated pump with adjustable vacuum control
- Self-closing connectors for quick installation and dismantling, prevention of drips, and containment of aerosols
- Liquid level sensor prevents overflow
- Single-channel and multi-channel nozzles and other accessory options available

Cat #	Vacuum range	Pump flow rate	Dimensions [W x D x H]	Weight	Input voltage	Bottle volume
01-270X	0 - 600 mbar	1-15 ml/s	180 x240 x 450mm	3 kg	100-240 VAC, 50/60 Hz	4L



## Classic Magnetic Stirrer

### Features

- Powerful rare-earth permanent magnet
- PET stirring plate provides excellent chemical resistance
- Stand included



## FlatSpin Magnetic Stirrer

### Features

- Ultra-flat, space-saving design
- Automatic rotation-reversing stirring for better mixing results
- Slip-resistant and stable



## Magnetic Stirrer Hotplate

### Features

- Digital control system
- ABS casing is fire-retardant and resistant to weak acids and bases
- Ceramic-coated stainless steel hotplate is chemically resistant and scratch-proof
- Safety feature: HOT caution indicator is displayed at 50°C and above

Cat #	Type	Stirring plate size [mm]	Motor input rating [W]	Motor output rating [W]	Max. stirring quantity [L, H <sub>2</sub> O]	Speed range [rpm]	Overheating Protection [°C]
01-330X	Classic	Ø 120	7.2	1.2	1.5	300-2000	-
01-320X	FlatSpin	Ø 90	5	3	0.8	15-1500	-
01-310X	Hotplate	Ø 135	5	3	3	100-1500	320





## Vortex Mixer

### Features

- Orbital mixing movement
- Touch and continuous operation settings
- Cast aluminum base and specially designed vacuum suction feet keep the mixer stable
- Various adapters and accessories available for use with tubes of different sizes ( $\Phi 6\text{mm}$ ,  $\Phi 10\text{mm}$ ,  $\Phi 12\text{mm}$ ,  $\Phi 16\text{mm}$ ,  $\Phi 20\text{mm}$  test tubes and vessels <math><99\text{mm}</math> in diameter)



Classic Rotators (axial)



Classic Rotators (radial)

## Classic Rotators

### Features

- End-over-end rotation
- Compact, space saving design
- Various adapters available for use with 1.5mL-50mL tubes

Cat #	Type	Speed range [rpm]	Operation mode	Voltage [V]	Power [W]
01-110X	Vortex Mixer	0-2500	Touch operation/Continuous	110-120/220-230	60
01-120X	Classic Rotator	0-80	Continuous	100-240	20
01-130X	Classic Rotator	0-80	Continuous	100-240	20

# Shakers



## Linear and Orbital Shakers

### Features

- Continuous operation
- Sturdy aluminum-alloy platform
- Tray platform, non-slip mat, and elastic bands included
- Various platforms available

Cat #	Type	Power [W]	Operation type	Max. load capacity (with platform) [kg]	Shaking speed range [rpm]
01-610X	Linear Shaker	30	Continuous	3	40-200
01-620X	Orbital Shaker	30	Continuous	3	40-200



## LED Digital Linear and Orbital Shakers

### Features

- Timed and continuous operation
- LED displays for timer and shaking speed

Cat #	Type	Power [W]	Operation type	Max. load capacity (with platform) [kg]	Shaking speed range [rpm]
01-611X	LED Digital Linear Shaker	30	Continuous	3	40-200
01-621X	LED Digital Orbital Shaker	30	Continuous	3	40-200



## Rocking and 3D Shakers

### Features

- Continuous operation
- Sturdy aluminum-alloy platform
- Tray platform, non-slip mat, and elastic bands included
- Various platforms available for use with different types of vessels

Cat #	Type	Power [W]	Shaking motion	Tilt angle	Max. load capacity (with platform) [kg]	Shaking speed range [rpm]
01-630X	Rocking Shaker	20	See-saw rocking	7°	3	10-80
01-640X	3D Shaker	20	3D orbital	7°	3	10-80



## LED Digital Rocking and 3D Shakers

### Features

- Timed and continuous operation
- LED displays for timer and shaking speed

Cat #	Type	Power [W]	Shaking motion	Tilt angle	Max. load capacity (with platform) [kg]	Shaking speed range [rpm]
01-631X	LED Digital Rocking Shaker	20	See-saw rocking	7 °	3	10-80
01-641X	LED Digital 3D Shaker	20	3D orbital	7 °	3	10-80

# Thermocyclers



## Gradient Thermocycler

### Features

- Thermal gradient: program different temperatures across different areas of the heating block
- Consistent and uniform sealing across entire heating block
- Intuitive touch-screen user interface



## Thermocycler

### Features

- Consistent and uniform sealing across entire heating block
- Intuitive touch-screen user interface

Cat #	Type	Heating Temperature Range [°C]	Temperature Display Accuracy [°C]	Max. Heating/Cooling Rate [°C/s]	Gradient Temperature Setting Range [°C]	Gradient Range [°C]
01-700X	Gradient Thermocycler	4-99	0.1	3	30-99	1-42
01-710X	Thermocycler	4-99	0.1	3	-	-



## Palm Micro Centrifuge

### Features

- Quick acceleration and deceleration
- Rotors for microcentrifuge tubes, PCR tubes, and PCR 8-strip tubes included.
- Quiet, low-noise design

Cat #	Type	Speed Range [rpm]	Max. RCF [×g]	Rotor Capacity
01-800X	Palm Micro Centrifuge	7000	2680	0.2ml/0.5ml/1.5ml/2ml x 8; 0.2ml PCR tubes x 16 or 0.2ml PCR 8-strips x 2



## Mini and Mini-Plus High Speed Centrifuges

### Features

- Brushless DC motor quickly accelerates rotor to the set speed
- Rotors are designed for 1.5ml and 2ml microcentrifuge tubes; adapters for 0.2ml and 0.5ml tubes are also available

### Specifications

- 01-820X (Mini) with 01-8292 aluminum alloy rotor kit\*
- High mechanical strength; fully autoclavable and lasts a lifetime
- 01-821X (Mini-Plus) with 01-8291 plastic rotor kit\*
- Low noise: 54dB; delivers fast acceleration and deceleration

Cat #	Type	Speed Range [rpm]	Max. RCF [×g]	Rotor Capacity	Speed Accuracy [rpm]	Temperature Range [°C]
01-820X	Mini High Speed Centrifuge	500-15000; increment: 100	15100; increment: 100	0.2ml/0.5ml/ 1.5ml/2.0ml x 12	±20	N/A
01-821X	Mini High Speed Centrifuge					



## High Speed Micro-Centrifuge

### Features

- Bio-safe rotor prevents sample overflow and ensures samples do not leak during the centrifuging process
- High strength aluminum alloy rotor is autoclavable and highly durable
- Four different rotors are available, assembled with 1.5ml/2ml x 24



## High Speed Refrigerated Micro-Centrifuge

### Features

- Powerful cooling system quickly cools chamber to 2°C after only 7 minutes, and keeps sample temperature below 2°C while centrifuging at maximum speed
- FastTemp: pre-cooling feature begins cool down prior to operation and ensures maximal temperature accuracy inside the chamber
- Four different rotors are available, assembled with 1.5ml/2ml x 24

Cat #	Type	Speed Range [rpm]	Max. RCF [xg]	Rotor Capacity	Speed Accuracy [rpm]	Temperature Range [°C]
01-830X	High Speed Micro-Centrifuge	200-15000; increment: 10	21380; increment: 10	5mlx18; 0.2ml/0.5ml/ 1.5ml/2ml x 24; 0.5ml x 36; PCR8 x 4	±20	N/A
01-831X	High Speed Refrigerated Micro-Centrifuge					-20-40



## Dry Bath Incubator

### Features

- A broad temperature range, from room temperature to 120°C
- Continuous and timed operation settings
- Over-temperature protection
- Various interchangeable heating blocks are available (0.2ml x 54, 0.5ml x 40, 1.5/2ml x 40, 5/15ml x 28, 50ml x 8, 0.2ml+0.5ml+1.5/2ml, 96 or 384 well plate)

Cat #	Type	Functions	Temperature uniformity [°C]	Overheating protection	Max heating rate [°C/min]
01-910X	Dry Bath Incubator	Heating	Max ± 0.5	140 °C	5.5



## Hot/Cold Dry Bath Incubator

### Features

- Excellent temperature control system
- Can maintain hot or cold temperatures
- Supports creating and saving custom operation programs
- Various interchangeable heating blocks are available (24 x 0.5ml, 24 x 1.5ml, 24 x 2ml, 8 x 5ml, 8 x 15ml, 4 x 50ml, well plate, 0.2 x 96 PCR plate)

Cat #	Type	Functions	Temperature range	Temperature control accuracy [°C, at 20–45°C]	Max heating rate [°C/min]
01-920X	Hot/Cold Dry Bath	Heating & cooling	Heating: room temp. ~110°C Cooling: room temp. ~ below room temp. 25°C	± 0.5	5.5

# Dry Bath Incubators



## Shaker Incubator

### Features

- Excellent temperature control system
- Can maintain hot or cold temperatures
- Orbital shaking movement function
- Supports creating and saving custom programs
- Various interchangeable heating blocks are available (24 x 0.5ml, 24 x 1.5ml, 24 x 2ml, 8 x 5ml, 8 x 15ml, 4 x 50ml, well plate, 0.2 x 96 PCR plate)

Cat #	Type	Functions	Temperature range	Max heating rate [°C/min]	Max cooling rate [°C/min]	Shaking speed range [rpm]
01-930X	Shaker Incubator	Heating, cooling, & mixing	Heating: room temp. ~100°C Cooling: room temp. ~ below room temp. 25°C	5.5	5 (110°C - room temp.) 0.5 (below room temp.)	300-1500



One Block Unit



Dual Block Unit

## Elite Series Dry Bath Incubators

### Features

- PID temperature control maintains temperature accuracy
- Leak-proof molded aluminum alloy chamber with PTFE coating
- Multi-functional: can also be used as a water bath or bead bath
- Various interchangeable heating blocks are available (0.2ml tubes x 64 or PCR 8-strip tubes x 8, 0.5ml tubes x 20, 1.5ml or 2.0ml tubes x 20, 15ml x centrifuge tubes x12, 50ml x centrifuge tubes x4)

\* Blocks are not included, need to buy separately.

Cat #	Type	Display	Temperature Control Range [°C]	Temperature Increment [°C]	Temperature Accuracy at 37 [°C]	Operation Modes
03-4221	Elite Series One-Block Dry Bath Incubator	LCD Display	5 above ambient to 150	0.10	±20	Continuous or timed up to 99 hr:59 min
03-4222	Elite Series Dual Block Dry Bath Incubator					





Mini 300V Power Supply



300V Power Supply

## Power Supplies

### Features

- Stackable and programmable
- Multiple safety features: no-load detection, shrouded plugs and sockets, leakage detection, over-temperature protection, crossover protection, full floating, over-current/over-voltage detection

Cat #	Type	Output Voltage / Inc [V]	Output Current / Inc [mA]	Max Power [W]
03-1300	Mini 300V Power Supply	10-300/1	10-400/1	60
03-2310	300V Power Supply	5-300/1	1-700/1	150



03-3100



03-3070

## Electrophoresis Tanks

### Features

- Injection molded, leak-proof tank
- No tapes, clamps, or springs required
- Low buffer consumption
- Multiple tray sizes and combs available

Cat #	Tank Dimensions [ W x L x H ]	Gel Dimensions [mm]	Max. Sample Capacity [mm]	Rapid Casting Gel
03-3070	210 x 90 x 90mm	70 x 70, 70 x 100	32 for 70 x 70    64 for 70 x 100	Offer gel maker
03-3100	220 x 125 x 90mm	100 x 70, 100 x 100	50 for 100 x 70    100 for 100 x 100	Offer gel maker

# BluView Transilluminator

Super bright blue LED lights can be used with a variety of safe dyes, and the lights are harmless and safe to view the experiment result. You can cut the gel with accuracy. With its compact size and light weight, the transilluminator occupies little of your lab bench and is easy to move from lab to lab.

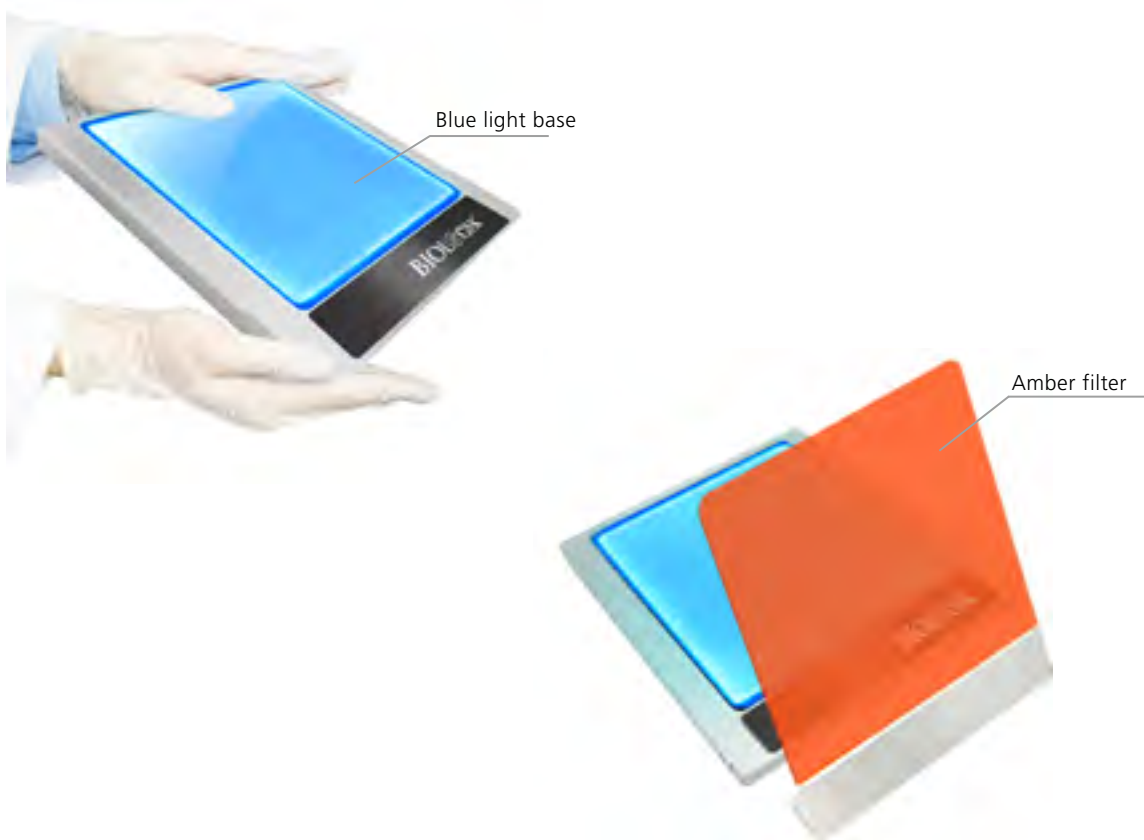

## BluView Transilluminator

### Features

- Compact, and easy to carry
- Aluminum alloy casing design
- Low heat dispersion
- Energy saving product
- 470nm harmless blue light for direct human contact
- Thinner and more lightweight body
- Use accessories to document experiment results by a smart phone

Cat #	Blue Light Wavelength [nm]	Base Design	Construction Material	Power Adaptor	Filter Viewing Surface Dimensions [mm]
03-6210	470	Flat bed	Aluminum alloy	12VDC/5A, 60W Max.	153×153

# Application Guidelines

## Maximum centrifugal acceleration force can be influenced by following criteria:

- Use of organic solutions, temperature below 0°C, centrifuging without centrifuge adapter, etc. Conduct a trial run to determine proper conditions before any critical use begins.
- The RCF (relative centrifugal force) or G ratings for our disposable centrifuge tubes have been established at room temperature using tubes filled to nominal capacity with water and centrifuging for 30 minutes. recommended carriers, adapters, and cushions that fully support the tubes. If an angle head rotor is used or proper support is not provided, G values will be lower.
- Do not confuse speed or revolutions per minute (RPM) with relative centrifugal force (RCF). Instructions for centrifuging a sample at a given RPM and time are incomplete unless the rotor or radius is specified. Protocols should always state the time and RCF value for centrifuging a sample.

## Autoclaving guideline for Plastics

To ensure successful steam sterilization of your plastic labware please adhere to the following guidelines:

PLEASE NOTE THAT NOT ALL PRODUCTS ARE AUTOCLAVABLE. Autoclave plastic consumables at 121°C and 15psi/1 atm for 15 minutes. Do not use a dry cycle, as this may cause deformation or weakening of the plastic. Allow temperature within the autoclave to return to 80°C or below before removing products.

## Our Commitment to Quality

At Biologix, we look at quality from every angle in terms of functionality, safety, purity, formulation, consistency, manufacturing, customer service, technical support, and much more, all in order to consistently ensure customer satisfaction.

According to the detailed QA/QC procedures for our manufacturing facility, each and every product is traceable by lot, regardless of packaging format. Products must go through a five-step human inspection before being released for packaging.

Our facility is equipped with the latest instruments and technology from the most trusted manufacturers, ensuring that Biologix applies the most stringent standards to certify that products are free from RNase, DNase, endotoxin (pyrogens), etc.

In addition to being ISO 9001:2008, CE, and FDA compliant, we also make available to our customers lot-specific certificates such as Sterilization Certificates, Nuclease Free Certificates, Certificates of Origin, etc. Certificates of Compliance can also be downloaded directly from our website: [www.BiologixGroup.com](http://www.BiologixGroup.com).

Note: Product parameters within this catalogue are for reference only.

# Chemical Resistance Form

For Biologix Plastic Laboratory Supplies

	PS	PP	HDPE	LDPE	PVC	CA	PC	CN	NY	MCE	PTFE	PET
<b>Acids</b>												
Hydrochloric acid (25%)	G	G	G	G	G	N	R	R	N	O	R	R
Hydrochloric acid (concentrated)	F	G	G	G	F	N	R	N	N	N	R	O
Nitric acid (concentrated)	P	P	N	N	P	N	R	N	N	N	O	N
Nitric acid (25%)	P	G	F	F	F	N	R	L	N	O	R	R
<b>Alcohols</b>												
Butanol	G	G	G	G	G	R	R	R	R	R	R	R
Ethanol	G	G	G	G	G	R	R	N	R	O	R	R
Methanol	G	G	G	G	G	R	R	N	R	O	R	R
<b>Amines</b>												
Aniline	G	G	G	G	P	N	N	R	R	N	R	O
Dimethylformamide	P	G	G	G	F	N	N	N	R	N	R	N
<b>Bases</b>												
Ammonium hydroxide (25%)	F	G	G	G	G	R	N	R	R	O	N	O
Ammonium hydroxide (1N)	F	G	G	G	G	N	N	R	R	O	N	N
Sodium hydroxide	G	G	G	G	G	N	N	N	R	N	R	N
<b>Hydrocarbons</b>												
Hexane	P	G	G	G	F	R	R	R	R	R	R	R
Toluene	P	G	N	N	P	R	O	R	R	R	R	N
Xylene	P	F	P	N	P	R	R	R	R	R	R	N
Dioxane	P	G	G	F	P	N	N	N	R	N	R	R
Dimethylsulfoxide (DMSO)	P	G	G	G	P	N	N	N	R	N	R	O*
<b>Halogenated Hydrocarbons</b>												
Chloroform	P	G	P	N	P	N	N	R	R	N	R	R
Methylene chloride	P	F	P	N	P	N	N	R	R	N	R	N
<b>Ketones</b>												
Acetone	P	G	G	G	P	N	O	N	R	N	R	R
Methyl ethyl diketone	P	G	G	G	P	N	O	N	R	O	R	R

\* Can be used with aqueous solutions containing up to 20% DMSO.

The above chemical resistance chart is meant to be used as a guide only.

## LEGEND

R = Recommended

L = Limited Resistance

N = Not Recommended

O = Testing Advised

F = Fair

G = Good

P = Poor

PS = Polystyrene

PP = Polypropylene

PVC = Polyvinyl Chloride

CA = Cellulose Acetate

PC = Polycarbonate

PTFE = Polytetrafluorethylene (Teflon)

CN = Cellulose Nitrate

NY = Nylon

MCE = Mixed Cellulose Esters

PET = Polyethylene Terephthalate



# BIOLGLIX®

## Biologix Group Limited

Phone: +86-531-67802668

## Biologix Corporation

No.2766 Ying Xiu Road  
High-Tech Industrial Development Zone  
Jinan, Shandong 250101  
P.R. China

[Inquiry@BiologixGroup.com](mailto:Inquiry@BiologixGroup.com)  
[www.BiologixGroup.com](http://www.BiologixGroup.com)  
[www.CryoKING.com](http://www.CryoKING.com)

## Biologix USA, Inc.

10555 86th Ave. Pleasant Prairie, WI 53158 , USA  
Phone: +1-888-3233585. 816  
+1-816-6597165

## Biologix Europe GmbH

Mathias-Brüggen-Str 156,  
50829 Köln, Germany

