

BIOLGLX[®]

Manufacturer and Supplier of Laboratory Products

www.Biologixgroup.com



Biologix Group Ltd

Biologix Group Limited is committed to the design and manufacture of high quality, reasonably-priced scientific and biomedical supplies. Throughout its long company history, Biologix has excelled at providing top quality laboratory supplies to distributors at logical prices.

Biologix has two brands: Biologix and Cryoking. Biologix brand focuses on offering the traditional regular lab consumables in the field of molecular biology, tissue culture, PCR, histology, microbiology etc; Cryoking brand focuses on the popular Biobank products which is truly the current prevailing trends in the near future.

Biologix most products manufactured in our FDA and ISO certified facilities are certified sterile, DNase and RNase free and non-pyrogenic using the highest quality medical-grade plastic materials. Some of the world's top laboratory supplies, in vitro diagnostic kits, and medical devices are also produced by Biologix as OEM and/or Private Labeled products.

Biologix Group Limited strives to provide our customers with exactly what they are looking for by engaging in market research and participating in continuous new product development. Your products needs and demands are important to us. Our focus is on building long-term relationships, allowing us to have a better understanding of the knowledge and experience your need to be successful in your market.

We have developed a focus on meticulous control and constant improvement and innovation, as well as setting standards of excellence in our industry. We are proud to serve thousands of laboratories, as well as hundreds of distributors, all around the world.



Ordering and Services

Private Labeling

Biologix offers a Private Labeling Program, providing high quality, branded lab supplies at very competitive prices. Many Biologix products are currently private labeled and sold worldwide by some of the most prominent brands and distributors.

OEM Services

Biologix also operates as an OEM provider for plastic laboratory consumables. With through our in-house molding and tooling capabilities, we can provide the exact products needed by our customers at significantly lower costs than other companies can achieve. Biologix currently supplies some of the world's top distributors with its OEM products.

Ordering Information

A. Free Product Samples

Let us send you a FREE sample package of our great products. Contact us today if you are interested in trying out Biologix products before you buy.

B. Distribution

If interested in distribution opportunities, please contact us for distributor terms and pricing. We are accepting distribution opportunities worldwide. Please contact us at Inquiry@BiologixGroup.com.

Guaranteed Quality

Exceptional Service

Professional Design

Logical Pricing

Certifications



CE



ISO



FDA

Contents

General Laboratory Supplies

Centrifuge Tubes	07
Microcentrifuge Tubes	08
Centrifuge Tube Racks	09
Pipet Tips	10
Filter Tips	11
Transfer Pipets	17
Solution Basins	18
Beakers	19
Reagent Bottles	20
Test Tubes	21
Slide Storage Boxes	22
Deep Well Plates	23
Microplate Sealers	24
Gloves	25

CryoKING Biobanking

Screw Cap Microtubes	27
Cryogenic Vials	28
Traditional Cryogenic Vials	29
CryoKING Cryogenic Vials	30
CryoKING Combo	31
Automated Product Series of SBS Standards	32
Premium Cardboard Cryogenic Boxes	33
ID-Color™ Cardboard Cryogenic Boxes	34
PC Cryogenic Boxes	35
PP Cryogenic Boxes	36
Freezer Racks	37,38
Screw Cap Capper/Decapper	39
Tube Handling System	40
Scanners	41
Biobanking Management Software	42
Ultra-low Temperature Freezers	43,44,45,46,47
Ultra-low Temperature Liquid	
Nitrogen Tanks	48,49,50

Cell Culture Series

Cell Culture Flasks	52
Cell Culture Dishes	53
Cell Culture Plates	54
Serological Pipettes	55
Cell Culture Slides	56
Cell Strainers	57
Cell Scrapers & Lifters	58

PCR

PCR Tubes	60
8-Strip PCR Tubes	61
PCR Plates	62,63

Microbiology

Petri Dishes	65
Inoculating Loops & Needles	66
Cell Spreaders	67

Drosophila

Drosophila Vials	69
Drosophila Bottles	70
Drosophila Plugs	71

Instruments

Liquid Handling	73,74
Collection System	75
Stirrers	76
Mixers & Rotators	77
Shakers	78,79
Thermocyclers	80
Centrifuges	81,82
Dry Bath Incubators	83,84
Electrophoresis	85
Transilluminators	86

Catalog Number Index

Cat #	Page#	Cat #	Page#	Cat #	Page#	Cat #	Page#
01-110X	77	04-0200	20	07-8175	52	41-5100	22
01-120X	77	04-0250	20	07-9025	52	41-6025	22
01-130X	77	04-0500	20	07-9075	52	41-6100	22
01-2101	73	04-1005	20	07-9175	52	51-0500	69
01-2102	73	04-1010	20	10-0151	07	51-0501	69
01-2104	73	04-1015	20	10-0152	07	51-0505	71
01-2110	73	04-1030	20	10-0501	07	51-0800	69
01-2115	73	04-1060	20	10-0502	07	51-0801	69
01-2122	73	04-1125	20	10-0815	07	51-0805	71
01-2155	73	04-1200	20	10-0850	07	51-17720	70
01-220X	74	04-1250	20	10-9151	07	51-17721	70
01-221X	74	04-1500	20	10-9152	07	51-17725	71
01-241X	73	04-2008	20	10-9501	07	60-0002	60
01-242X	73	04-2015	20	10-9502	07	60-0008	61
01-243X	73	04-2030	20	10-9815	07	60-0056	62
01-244X	73	04-2060	20	10-9850	07	60-0082	60
01-270X	75	04-2100	20	12-1275	21	60-0088	61
01-2801	73	04-2125	20	12-1299	21	60-0102	60
01-2805	73	04-2250	20	12-1300	21	60-0108	61
01-2830	73	04-2500	20	12-1399	21	60-0156	62
01-310X	76	04-3008	20	12-2275	21	60-0182	60
01-320X	76	04-3015	20	15-1040	57	60-0188	61
01-330X	76	04-3030	20	15-1070	57	60-0202	60
01-610X	78	04-3060	20	15-1100	57	60-0208	61
01-611X	78	04-3100	20	20-0010	10	60-0256	62
01-620X	78	04-3125	20	20-0200	10	60-0282	60
01-621X	78	04-3250	20	20-1000	10	60-0288	61
01-630X	79	04-3500	20	20-1250	10	60-0302	60
01-631X	79	05-2720	75	20-1251	10	60-0308	61
01-640X	79	05-2721	75	21-0010	10	60-0356	62
01-641X	79	05-2791	75	21-0200	10	60-0382	60
01-700X	80	05-2792	75	21-1000	10	60-0388	61
01-710X	80	05-2793	75	21-1250	10	60-0402	60
01-800X	81	05-2797	75	22-0010	11	60-0408	61
01-821X	81	05-2798	75	22-0011	11	60-0456	62
01-830X	82	07-2101	56	22-0200	11	60-0482	60
01-831X	82	07-2102	56	22-0201	11	60-0488	61
01-910X	83	07-2104	56	22-1000	11	61-0010	24
01-920X	83	07-2108	56	22-1001	11	61-0020	24
01-930X	84	07-3035	53	23-0010	11	61-0040	24
02-1016	23	07-3060	53	23-0011	11	61-0041	24
02-1022	23	07-3100	53	23-0200	11	61-0051	24
02-2010	23	07-3150	53	23-0201	11	61-0060	24
03-1300	85	07-5001	55	23-1000	11	61-0080	24
03-2310	85	07-5002	55	23-1001	11	61-0120	24
03-3070	85	07-5005	55	25-0051	18	61-0152	24
03-3100	85	07-5010	55	25-0052	18	61-0210	24
03-4221	84	07-5025	55	25-1025	18	61-0303	24
03-4222	84	07-5050	55	25-1100	18	61-0304	24
03-6210	86	07-6006	54	25-1202	18	65-0001	66
04-0005	20	07-6012	54	30-0135	17	65-0002	66
04-0010	20	07-6024	54	30-0135A1	17	65-0010	66
04-0015	20	07-6048	54	30-0138	17	65-1001	67
04-0030	20	07-6096	54	30-0138A1	17	65-1010	67
04-0060	20	07-8025	52	30-0238A1	17	66-1501	65
04-0125	20	07-8075	52	41-5025	22	66-1515	65

Catalog Number Index

Cat #	Page#	Cat #	Page#	Cat #	Page#	Cat #	Page#
66-1560	65	88-620X	29	90-9250	35	CKD-V160S013	48
66-1701	65	88-621X	29	90-9381	35	CKD-V180S013	48
70-1180	58	88-650X	29	93-0050	19	CKD-V180S014	48
70-1250	58	88-720X	30	93-0100	19	CKF-CL090	46
70-2180	58	88-721X	30	93-0250	19	CKF-CL270	46
7101	22	88-750X	30	93-0400	19	CKF-CL450	46
7105	22	88-905X	30	93-0800	19	CKF-CL531	46
80-0015	08	88-910X	30	93-1000	19	CKF-M260	47
80-0020	08	88-915X	30	96-2216	38	CKF-M300	47
80-0500	08	88-920X	30	96-2220	38	CKF-M520	47
80-1500	08	88-921X	30	96-2224	38	CKF-M728	47
80-1501	08	88-950X	30	96-62XX	38	CKF-M968	47
80-1502	08	89-403X	32	96-7216	37	CKF-M1500	47
80-1503	08	89-405X	32	96-7220	37	CKF-UL100	45
81-0000	27	89-408X	32	96-7224	37	CKF-UL290	45
81-0001	27	89-410X	32	97-1111	25	CKF-UL340	45
81-0002	27	89-423X	32	97-1112	25	CKF-UL398	44
81-0003	27	89-425X	32	97-1113	25	CKF-UL508	45
81-0004	27	89-428X	32	97-1114	25	CKF-UL528	44
81-0005	27	89-421X	32	97-1115	25	CKF-UL538	45
81-0006	27	89-905X	31	97-6111	25	CKF-UL540	45
81-0053	27	89-910X	31	97-6112	25	CKF-UL668	45
81-0054	27	89-915X	31	97-6113	25	CKF-UL678	43
81-0055	27	89-920X	31	97-6114	25	CKF-UL778	43
81-0056	27	89-921X	31	97-6115	25	CKF-UL858	43
81-0153	27	89-922X	31	98-0113	35	CKF-UL1008	43
81-0154	27	89-923X	31	98-0200	35	CKF-UW138	45
81-0203	27	89-950X	31	98-0213	35	CKF-UW328	45
81-0204	27	90-1200	33	98-0313	35	CKF-UW438	45
81-7053	28	90-1281	33	98-1213	35	CKS-0101	41
81-7054	28	90-1300	33	98-4117	32	CKS-0201	41
81-7055	28	90-1381	33	98-4217	32	CKS-1008	39
81-7056	28	90-1536	09	98-4127	32	CKS-1096	39
81-7153	28	90-1550	09	98-4227	32	CKS-1520	40
81-7154	28	90-2200	33	99-2120	38	CKS-152X	40
81-7203	28	90-2281	33	99-2124	38	CKS-1101	41
81-7204	28	90-2300	33	99-2216	38	CKS-1301	41
81-7205	28	90-2381	33	99-2220	38	CKS-L010Q125	49
81-8204	28	90-5016	09	99-2224	38	CKS-L030Q125	49
88-005X	30	90-5025	09	99-5216	37	CKS-L035Q125	49
88-010X	30	90-5200	33	99-5220	37	CKS-L065Q216	49
88-015X	30	90-5281	33	99-62XX	38	CKS-L095Q216	49
88-020X	30	90-8009	09	99-7128	37	CKS-L115Q216	49
88-021X	30	90-8100	34	99-7216	37	CKS-L175Q216	49
88-050X	30	90-8200	34	99-7220	37	CKS-L047W127	49
88-403X	32	90-8281	34	99-7224	37	CKS-P302Z030	50
88-405X	32	90-8381	34	CKD-V035S013	48	CKS-P302Z035	50
88-408X	32	90-9009	35	CKD-V045S013	48	CKS-P603Z050	50
88-410X	32	90-9025	36	CKD-V055S013	48	CKS-P606Z050	50
88-600X	29	90-9081	36	CKD-V075S013	48	CKS-P610Z050	50
88-605X	30	90-9100	36	CKD-V085S013	48		
88-610X	30	90-9200	36	CKD-V100S013	48		
88-615X	30	90-9210	35	CKD-V130S013	48		

General Laboratory Supplies

The General Laboratory Supplies section includes many consumables commonly used in basic laboratory and medical procedures. From centrifuge tubes and test tubes to disposable gloves and microscope slides, many of these general laboratory supplies may have applications in multiple life science fields.





>> Features

- Tubes: made of strong, highly transparent medical grade polypropylene
- Flat-top caps: made of medical grade polyethylene
- Plug-seal screw on caps: made of medical grade polypropylene
- 15ml and 50ml conical tubes available;
- Large white writing area for easy marking
- Double threaded design reduces cross-threading; caps are easily opened and closed
- Flat-top caps can be written on
- Gamma radiation sterilized, non-pyrogenic, RNase&DNase free
- Available in racked package (sterile) or bulk package (sterile & non-sterile)

Specifications

- Working temperature: stable from -20°C to 121°C (except flat-top cap)
- 15ml and 50ml tubes can withstand centrifugation of 8,400 and 9,400 RCF respectively
- Sealing test: complies with the International Air Transport Association (IATA) Safety Standards



Cat #	Volume	Caps	Sterile	Package	Unit	Total
10-9151	15ml	Flat Top	Yes	Rack	50 /Rack, 10 Racks /Case	500 /Case
10-9152	15ml	Flat Top	Yes	Bulk	25 /Bag, 20 Bags /Case	500 /Case
10-9501	50ml	Flat Top	Yes	Rack	25 /Rack, 20 Racks /Case	500 /Case
10-9502	50ml	Flat Top	Yes	Bulk	25 /Bag, 20 Bags /Case	500 /Case
10-9815	15ml	Flat Top	No	Bulk	500 /Case	500 /Case
10-9850	50ml	Flat Top	No	Bulk	500 /Case	500 /Case
10-0151	15ml	Plug Seal	Yes	Rack	50 /Rack, 10 Racks /Case	500 /Case
10-0152	15ml	Plug Seal	Yes	Bulk	25 /Bag, 20 Bags /Case	500 /Case
10-0501	50ml	Plug Seal	Yes	Rack	25 /Rack, 20 Racks /Case	500 /Case
10-0502	50ml	Plug Seal	Yes	Bulk	25 /Bag, 20 Bags /Case	500 /Case
10-0815	15ml	Plug Seal	No	Bulk	500 /Case	500 /Case
10-0850	50ml	Plug Seal	No	Bulk	500 /Case	500 /Case

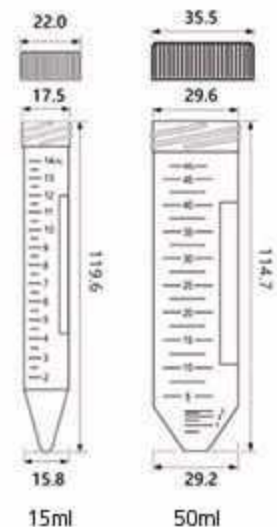

Dimensions = mm

Microcentrifuge Tubes



>> Features

- Made of high quality medical grade polypropylene
- Transparent tube walls permit easy viewing of contents
- Beveled lip for convenient one-handed operation
- Writing area and attached flat cap for labeling

Specifications

- Working temperature: stable from -20°C to 121°C
- Can withstand high speed centrifugation of 20,000 RCF



80-0020

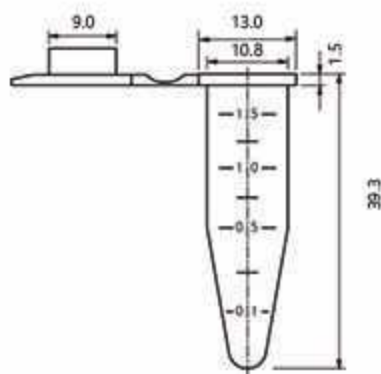

Dimensions = mm

Cat #	Volume	Color	Sterile	RNase & DNase free	Unit	Total
80-0500	0.5ml	Clear	No	Yes	500 /Bag/Pack, 10 Packs/Case	5000 /Case
80-0015	1.5ml	Clear	No	Yes	500 /Bag/Pack, 10 Packs/Case	5000 /Case
80-1500	1.5ml	Clear	No	Yes	500 /Bag/Pack, 10 Packs/Case	5000 /Case
80-0020	2.0ml	Clear	No	No	500 /Bag/Pack, 10 Packs/Case	5000 /Case
80-1501*	1.5ml	Red	No	Yes	500 /Bag/Pack, 10 Packs/Case	5000 /Case
80-1502*	1.5ml	Yellow	No	Yes	500 /Bag/Pack, 10 Packs/Case	5000 /Case
80-1503*	1.5ml	Blue	No	Yes	500 /Bag/Pack, 10 Packs/Case	5000 /Case

* Call for details

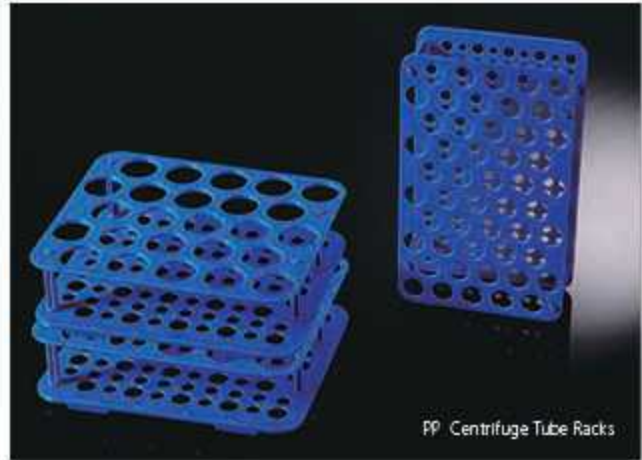
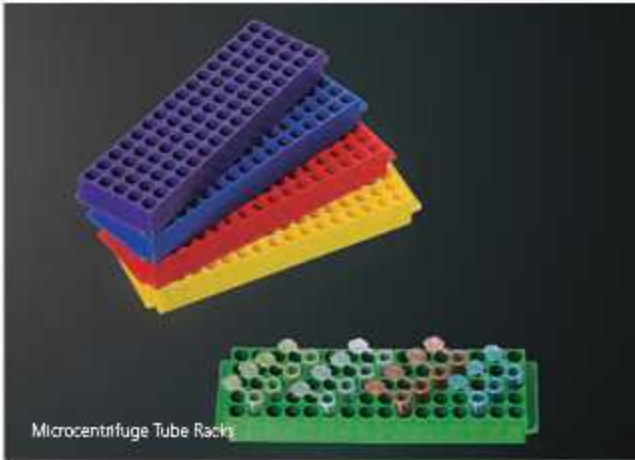

>> Features

Microcentrifuge Tube Racks

- Made of high strength plastic, chemically resistant to alcohols and mild organic solvents
- Writing area on side of rack for easy marking
- Handles on each end for secure handling
- 5x16 array, 80 wells, molded with a numeric grid for easy tube identification
- Fit for 1.5ml, 2.0ml microcentrifuge tubes and screw cap tubes

PP Centrifuge Tube Racks

- Made of high quality medical grade polypropylene
- 50-well racks hold 15ml centrifuge tubes
- 25-well racks hold 50ml centrifuge tubes
- Sturdy design keeps tubes upright

Cardboard Centrifuge Tube Racks

- Made of durable cardboard with superior white coating, chemically resistant to alcohols and mild organic solvents
- 36-well racks for 15ml centrifuge tubes, 16-well racks for 50ml centrifuge tubes
- Removable lid features a lined writing area



Cardboard Centrifuge Tube Rack
Working temperature:
from -196 °C to 121°C

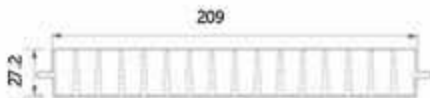

90-8009

Dimensions = mm

Cat #	Well	Color	Sterile	Unit	Total
90-8009	80-well	Assorted Colors	No	5 /Bag, 4 Bags/Case	20 /Case
90-1536	36-well	White	No	5 /Bag, 20 Bags/Case	100 /Case
90-5016	16-well	White	No	5 /Bag, 20 Bags/Case	100 /Case
90-1550	50-well	Blue	No	1 /Bag, 20 Bags/Case	20 /Case
90-5025	25-well	Blue	No	1 /Bag, 20 Bags/Case	20 /Case

Pipet Tips

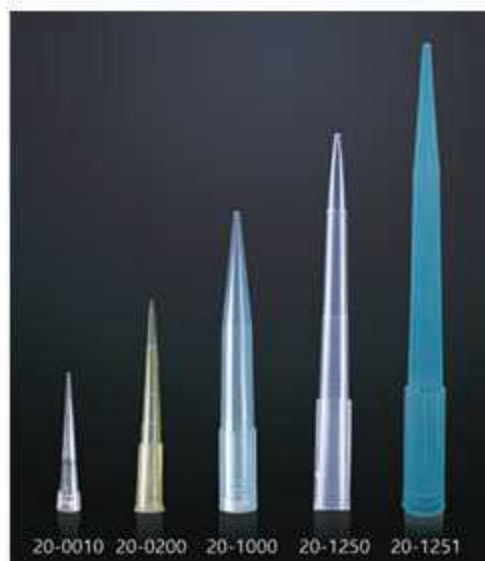

>> Features

- Made of polypropylene, autoclavable
- Available in 10µl, 200µl and 1000µl sizes, suitable for standard manual and electronic pipettes
- 10µl and 200µl tips are graduated, 200µl tips have a beveled point design that reduces sample retention
Extended 1000µl tips facilitate pipetting from deep or narrow containers
- RNase & DNase free, non-pyrogenic
- Available in racked package (sterile) and bulk package (non-sterile)

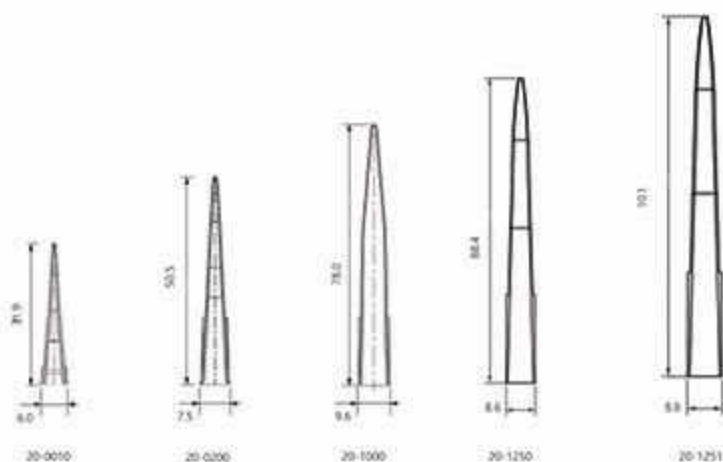

Dimensions = mm

Cat #	Volume	Color	Sterile	Unit	Total
20-0010	10µl	Natural	No	1,000 /Bag, 2 Bags /Pack, 5 Packs/Case	10000 /Case
21-0010	10µl	Natural	Yes	96 /Rack, 10 Racks/Pack, 10 Packs/Case	9600 /Case
20-0200	200µl	Yellow	No	1,000 /Bag/Pack, 10 Packs/Case	10000 /Case
21-0200	200µl	Yellow	Yes	96 /Rack, 10 Racks/Pack, 10 Packs/Case	9600 /Case
20-1000	1000µl	Blue	No	1,000 /Bag/Pack, 10 Packs/Case	10000 /Case
21-1000	1000µl	Blue	Yes	100 /Rack, 6 Racks/Pack, 10 Packs/Case	6000 /Case
20-1250	1000µl Extended	Natural	No	1,000 /Bag/Pack, 10 Packs/Case	10000 /Case
21-1250	1000µl Extended	Natural	Yes	96 /Rack, 6 Racks/Pack, 10 Packs/Case	5760 /Case
20-1251	1000µl Extra-Long	Blue	No	1,000 /Bag/Pack, 10 Packs/Case	10000 /Case



>> Features

- Tips are made of medical grade polypropylene, and filters are made of highly hydrophobic UHMWPE
- Filters prevent cross-contamination and damage to samples, ensure accurate and precise sample aspiration, and protect the user by preventing sample liquid or vapor from entering the pipette body
- Standard filter tips and low retention filter tips available in all sizes
- Low retention treated tips undergo a coating-free treatment and will not contaminate samples
- All filter tips are autoclavable
- Available in racked package (sterile) and bulk package (non-sterile)
- RNase & DNase free, non-pyrogenic



Small and uniform filter pore size ensures the accuracy and precision of sample aspiration

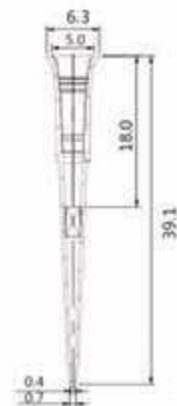

10µl Dimensions=mm

Cat #	Volume	Color	Sterile	Low Retention	Unit	Total
22-0010	10µl	Natural	No	No	1,000 /Bag, 2 Bags/Pack, 5 Packs /Case	10000 /Case
22-0011	10µl	Natural	No	Yes	1,000 /Bag, 2 Bags/Pack, 5 Packs /Case	10000 /Case
23-0010	10µl	Natural	Yes	No	96 /Rack, 10 Racks/Pack, 10 Packs/Case	9600 /Case
23-0011	10µl	Natural	Yes	Yes	96 /Rack, 10 Racks/Pack, 10 Packs/Case	9600 /Case
22-0200	200µl	Natural	No	No	1,000 /Bag/Pack, 10 Packs /Case	10000 /Case
22-0201	200µl	Natural	No	Yes	1,000 /Bag/Pack, 10 Packs /Case	10000 /Case
23-0200	200µl	Natural	Yes	No	96 /Rack, 10 Racks/Pack, 10 Packs/Case	9600 /Case
23-0201	200µl	Natural	Yes	Yes	96 /Rack, 10 Racks/Pack, 10 Packs/Case	9600 /Case
22-1000	1000µl	Natural	No	No	1,000 /Bag/Pack, 10 Packs /Case	10000 /Case
22-1001	1000µl	Natural	No	Yes	1,000 /Bag/Pack, 10 Packs /Case	10000 /Case
23-1000	1000µl	Natural	Yes	No	96 /Rack, 6 Racks/Pack, 10 Packs/Case	5760 /Case
23-1001	1000µl	Natural	Yes	Yes	96 /Rack, 6 Racks/Pack, 10 Packs/Case	5760 /Case

Pipet Tip Compatibility

Pipettor Brand/Make	Volume Range	0.5-10µl	20-0010	0.5-10µl	21-0010	1-200µl	20-0200	1-200µl	21-0200	100-1000µl	20-1000	100-1000µl	21-1000	100-1000µl	20-1250	100-1000µl	20-1250	0.5-10µl	21-1250	0.5-10µl	22-0010	0.5-10µl	22-0011	0.5-10µl	23-0010	1-200µl	23-0011	1-200µl	22-0200	1-200µl	22-0201	1-200µl	23-0200	1-200µl	23-0201	100-1000µl	22-1000	100-1000µl	22-1001	100-1000µl	23-1000					
Axygen Axyjet (single channel)	0.1-2µl	✓	✓															✓	✓	✓	✓																									
	0.5-10µl	✓	✓															✓	✓	✓	✓																									
	2-20µl					✓	✓																																							
	5-50µl					✓	✓																																							
	10-100µl					✓	✓																																							
	20-200µl					✓	✓																				✓	✓	✓	✓																
	50-250µl																																													
	100-1000µl																																													
Axygen Axyjet (multichannel)	1-10µl	✓	✓															✓	✓	✓	✓																									
	5-50µl					✓	✓																																							
	20-200µl					✓	✓																			✓	✓	✓	✓																	
	50-300µl					✓	✓																																							
Axygen Axyjet-16	0.2-2µl																																													
	0.5-10µl																																													
	5-50µl																																													
Bohli Proline (single channel)	0.2-10µl	✓	✓															✓	✓	✓	✓																									
	5-100µl					✓	✓																																							
	10-250µl					✓	✓																				✓	✓	✓	✓																
	10-500µl									✓	✓	✓	✓	✓																																
	50-1000µl									✓	✓	✓	✓	✓																																
Bohli Proline (multichannel)	0.2-10µl	✓	✓															✓	✓	✓	✓																									
	5-100µl					✓	✓																				✓	✓	✓	✓																
	25-250µl					✓	✓																				✓	✓	✓	✓																
Bohli e-Line (single channel)	1-10µl	✓	✓															✓	✓	✓	✓																									
	5-120µl					✓	✓																																							
	10-300µl					✓	✓																																							
	50-1000µl									✓	✓	✓	✓	✓																																
Bohli e-Line (multichannel)	0.2-10µl	✓	✓															✓	✓	✓	✓																									
	5-120µl					✓	✓																				✓	✓	✓	✓																
	10-300µl					✓	✓																																							
Bohli m-Line (single channel)	0.5-10µl																																													
	2-20µl					✓	✓																																							
	10-100µl					✓	✓																																							

Pipet Tip Compatibility

0.5-10µl	0.5-10µl	1-200µl	1-200µl	100-1000µl	100-1000µl	100-1000µl	100-1000µl	100-1000µl	100-1000µl	0.5-10µl	0.5-10µl	0.5-10µl	0.5-10µl	1-200µl	1-200µl	1-200µl	1-200µl	100-1000µl	100-1000µl	100-1000µl	Volume/Biology Tip	Volume Range	Pipettor Brand/Make				
✓	✓									✓	✓	✓	✓									0.1-10µl	Eppendorf Reference (single channel) (multichannel)				
		✓	✓																			2-20µl					
		✓	✓																			10-100µl					
		✓	✓											✓	✓	✓	✓					20-200µl					
				✓	✓	✓	✓	✓						✓	✓	✓	✓	✓	✓	✓		100-1000µl					
✓	✓									✓	✓	✓	✓									0.1-2.5µl	Eppendorf Research (single channel)				
✓	✓									✓	✓	✓	✓									0.5-10µl					
		✓	✓																			2-20µl					
		✓	✓																			10-100µl					
														✓	✓	✓	✓					25-200µl					
				✓	✓	✓	✓	✓														✓	✓	✓	100-1000µl		
✓	✓									✓	✓	✓	✓										0.5-10µl	Eppendorf Research (multichannel)			
										✓	✓	✓	✓										5-100µl				
		✓	✓																				50-100µl				
		✓	✓											✓	✓	✓	✓						20-300µl				
		✓	✓	✓	✓									✓	✓	✓	✓						30-300µl				
		✓	✓	✓	✓																	✓	✓	✓	50-1200µl		
✓	✓									✓	✓	✓	✓										0.2-10µl	Thermo Scientific Finnpipette (single channel)			
✓	✓									✓	✓	✓	✓										0.5-10µl				
		✓	✓																				5-40µl				
		✓	✓											✓	✓	✓	✓						40-200µl				
				✓	✓	✓	✓	✓														✓	✓		✓	100-1000µl	
				✓	✓	✓	✓	✓														✓	✓	✓	200-1000µl		
		✓	✓																				5-50µl	Thermo Scientific Finnpipette (multichannel)			
		✓	✓											✓	✓	✓	✓						50-300µl				
✓	✓									✓	✓	✓	✓										P2, 0.1-2µl	Gilson Pipetman (single channel)			
✓	✓									✓	✓	✓	✓										P10, 0.2-10µl				
		✓	✓																				P20, 2-20µl				
		✓	✓																				P100, 10-100µl				
		✓	✓											✓	✓	✓	✓						P200, 20-200µl				
				✓	✓	✓	✓	✓														✓	✓		✓	P1000, 100-1000µl	
		✓	✓											✓	✓	✓	✓						P200-M8, 20-200µl (m/c)				



>> Features

- Polyethylene pipettes will not shatter or break
- An excellent alternative to Pasteur pipettes and rubber bulbs
- Evenly distributed thickness ensures uniform suction force
- Gamma radiation sterilized option available
- Available wrapped individually (sterile) or in bulk package (non-sterile)

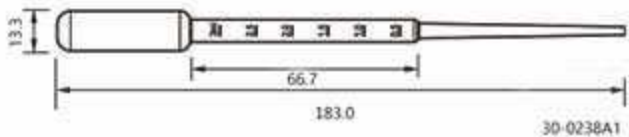
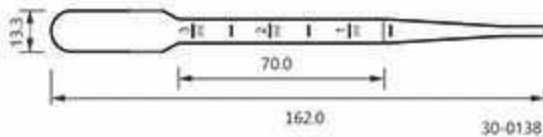
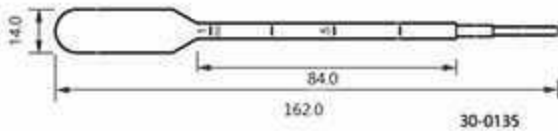
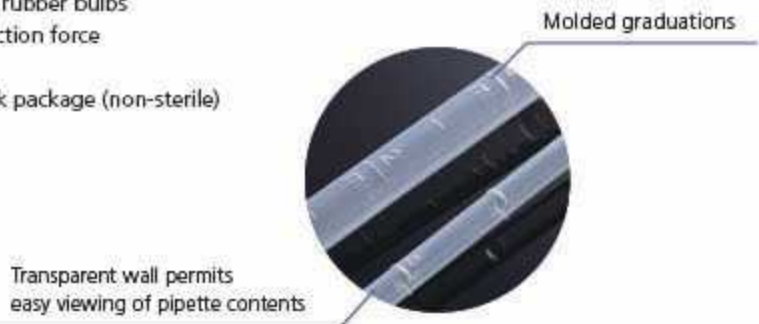

Dimensions = mm

Cat #	Length	Graduated To	Sterile	Package	Unit	Total
30-0135	162.0mm	1ml	No	Bulk	500 /Pack, 4 Packs/Case	2000 /Case
30-0135A1	162.0mm	1ml	Yes	Individually Wrapped	500 /Pack, 4 Packs/Case	2000 /Case
30-0138	162.0mm	3ml	No	Bulk	500 /Pack, 4 Packs/Case	2000 /Case
30-0138A1	162.0mm	3ml	Yes	Individually Wrapped	500 /Pack, 4 Packs/Case	2000 /Case
30-0238A1	183.0mm	3ml	Yes	Individually Wrapped	500 /Pack, 4 Packs/Case	2000 /Case

Solution Basins



>> Features

- Made of PVC, polystyrene (PS), or strong polypropylene (PP)
- PVC basins have transparent walls to permit easy viewing of contents
- Polypropylene basins are chemically resistant to alcohols and mild organic solvents
- PS one-channel basins are available in three sizes: 25ml, 55ml, and 100ml; 25ml and 55ml basins have a V-shaped bottom design
- PVC one-channel basins have a capacity of 55ml and a V-shaped bottom design
- PP 12-channel basins are double sided: the 12-channel side has a capacity of 5ml per channel; the other side (single-channel) has a capacity of 50ml
- PP 12-channel basins are available in assorted colors: clear, blue, green, pink, and yellow
- PS basins are individually packaged (sterile); PVC and PP basins are bulk packaged (non-sterile)

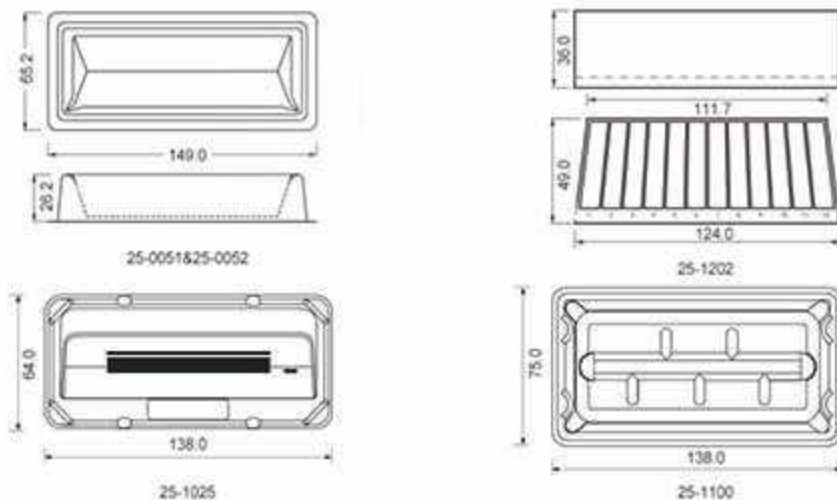

Dimensions = mm

Cat #	Volume	Material	Color	Sterile	Package	Unit	Total
25-1025	25ml	PS	White	Yes	Individually Wrapped	1 /Bag, 100 Bags/Case	100 /Case
25-1202	50ml	PP	Assorted Colors	No	Bulk	25 /Bag, 4 Bags/Case	100 /Case
25-0052	55ml	PVC	Clear	No	Bulk	100 /Bag, 8 Bags/Case	800 /Case
25-0051	55ml	PS	White	Yes	Individually Wrapped	1 /Bag, 100 Bags/Case	100 /Case
25-1100	100ml	PS	White	Yes	Individually Wrapped	1 /Bag, 50 Bags/Case	50 /Case



>> Features

- Made of strong, medical grade polypropylene, autoclavable
- Tri-corner design provides three dripless pouring spouts
- Six different sizes meet different needs

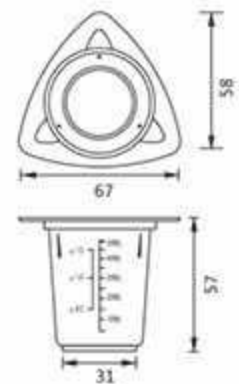
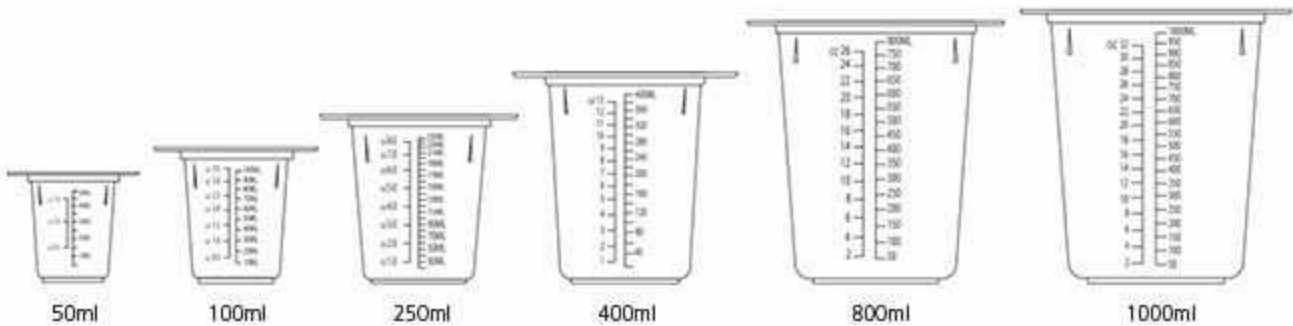

Cat #	Volume	Sterile	Unit	Total
93-0050	50ml	No	25 Pieces/Sleeve, 4 Sleeves/Case	100 /Case
93-0100	100ml	No	25 Pieces/Sleeve, 4 Sleeves/Case	100 /Case
93-0250	250ml	No	25 Pieces/Sleeve, 4 Sleeves/Case	100 /Case
93-0400	400ml	No	25 Pieces/Sleeve, 4 Sleeves/Case	100 /Case
93-0800	800ml	No	25 Pieces/Sleeve, 4 Sleeves/Case	100 /Case
93-1000	1,000ml	No	25 Pieces/Sleeve, 4 Sleeves/Case	100 /Case

Dimensions - mm

Reagent Bottles



>> Features

- Made of durable medical grade polypropylene or high-density polyethylene
- Uniform wall thickness and strength, impact-resistant, great chemical resistance to most acid, alkali and alcohol
- Polypropylene bottles are autoclavable
- Wide-mouth design enables the superior sealing performance, and the convenience for filling liquid
- Linerless caps provide the ultimate in leakproof protection without the use of liner that can wrinkle, cause leaks or contaminate your reagents
- Natural and brown bottles are available
- Brown bottles reduce UV light transmissions to protect light-sensitive liquids Natural bottles are convenient to observe inner items
- Various volumes are available: 5ml, 8ml, 10ml, 15ml, 30ml, 60ml, 125ml, 200ml, 250ml, 500ml, and 1000ml



Cat # (Natural)	Cat # (Brown)	Volume	Material	Unit
04-0005	04-1005	5ml	PP	2000 /Case
04-0010	04-1010	10ml	PP	1200 /Case
04-0015	04-1015	15ml	PP	1200 /Case
04-0030	04-1030	30ml	PP	800 /Case
04-0060	04-1060	60ml	PP	400 /Case
04-0125	04-1125	125ml	PP	250 /Case
04-0200	04-1200	200ml	PP	200 /Case
04-0250	04-1250	250ml	PP	150 /Case
04-0500	04-1500	500ml	PP	120 /Case
04-2008	04-3008	8ml	Bottles: HDPE, Caps: PP	1000 /Case
04-2015	04-3015	15ml	Bottles: HDPE, Caps: PP	1000 /Case
04-2030	04-3030	30ml	Bottles: HDPE, Caps: PP	400 /Case
04-2060	04-3060	60ml	Bottles: HDPE, Caps: PP	650 /Case
04-2125	04-3125	125ml	Bottles: HDPE, Caps: PP	350 /Case
04-2250	04-3250	250ml	Bottles: HDPE, Caps: PP	200 /Case
04-2500	04-3500	500ml	Bottles: HDPE, Caps: PP	100 /Case
04-2100	04-3100	1000ml	Bottles: HDPE, Caps: PP	50 /Case



PS



PP

>> Features

- Tubes: made of medical grade polystyrene or polypropylene
- Caps: made of medical grade polyethylene
- Tubes are available in two sizes: 12 x 75mm and 13 x 100mm

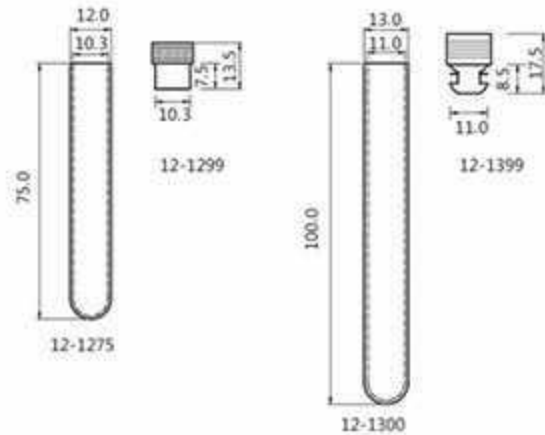

Dimensions - mm

Cat #	Description	Size(mm)	Material	Color	Volume	Sterile	Unit	Total
12-1275	Tube	12x75	PS	Clear	5ml	No	500 /Bag, 4 Bags/Case	2000 /Case
12-2275	Tube	12x75	PP	Clear	5ml	No	500 /Bag, 4 Bags/Case	2000 /Case
12-1300	Tube	13x100	PS	Clear	8ml	No	250 /Bag, 8 Bags/Case	2000 /Case
12-1299	Cap	12x13.5	PE	Blue	-	No	1,000 /Bag, 2 Bags/Case	2000 /Case
12-1399	Cap	13x17.5	PE	Red	-	No	1,000 /Bag, 2 Bags/Case	2000 /Case

Slide Storage Boxes

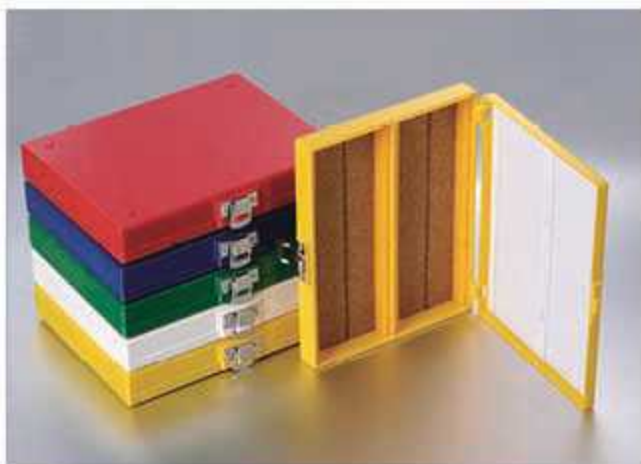

>> Features

Microscope Slides

- Made of high quality, highly transparent glass
- Slide faces are highly polished
Ground edges prevent chipping and personal injury
- Slides with frosted area are convenient for labeling and storage
Slides without frosted area have a larger usable surface area

Slide Storage Boxes

- Made of strong ABS material
- Available in 25-place or 100-place sizes
- Traditional cork or foam lining available
- 5 assorted colors available: red, yellow, green, blue, and white
- Stores 25mm x 75mm microscope slides
- Each slot is numbered to correspond to the slide inventory sheet inside the lid
- 100-place slide boxes are secured with a rust-resistant clasp and hinge pin

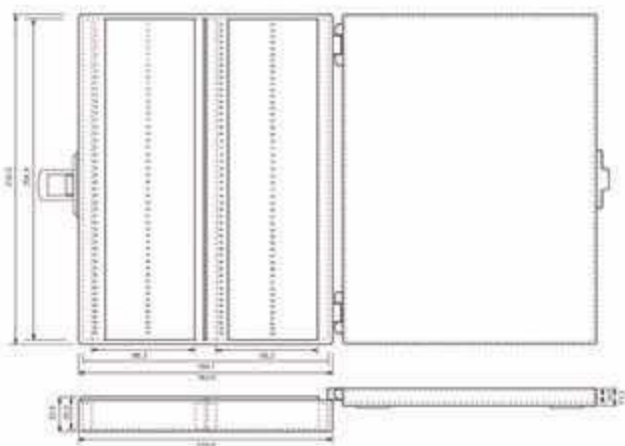

41-5100

Dimensions = mm

Microscope Slides

Cat #	Material	Type	Size (mm)	Sterile	Unit	Total
7101	Clear Glass	Plain Slides	25.4 x 76.2	No	72 /Pack, 50 Packs/Case	3600 /Case
7105	Clear Glass	Single Frosted End	25.4 x 76.2	No	72 /Pack, 50 Packs/Case	3600 /Case

Slide Storage Boxes

Cat #	Place	Lining	Color	Sterile	Unit	Total
41-5025	25-place	Foam	Assorted	No	5 /Bag, 4 Bags/Case	20 /Case
41-6025	25-place	Cork	Assorted	No	5 /Bag, 4 Bags/Case	20 /Case
41-5100	100-place	Foam	Assorted	No	5 /Bag, 6 Bags/Case	30 /Case
41-6100	100-place	Cork	Assorted	No	5 /Bag, 6 Bags/Case	30 /Case

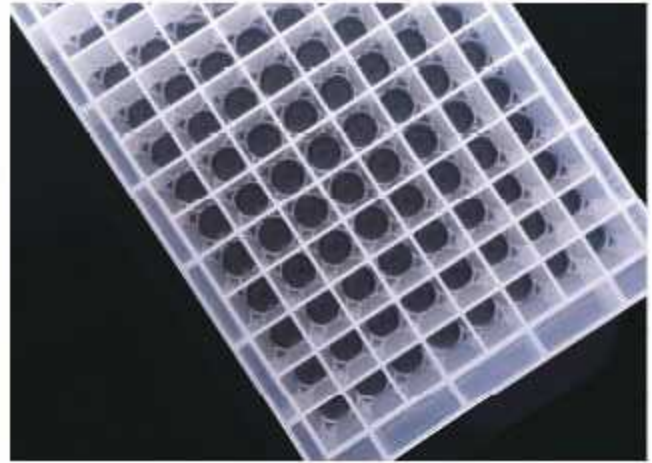
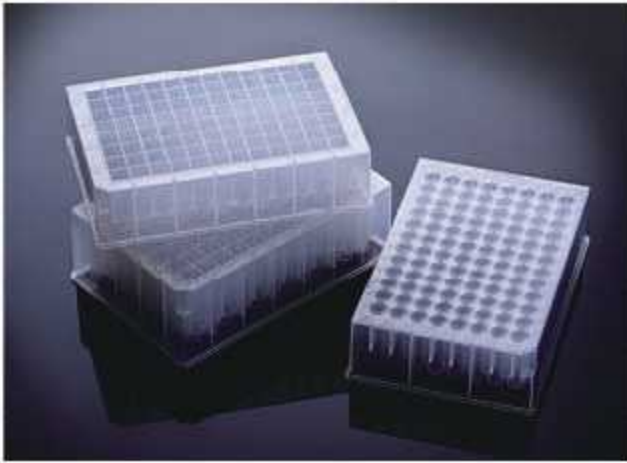

>> Features

- Made of medical grade polypropylene
- Chemically resistant to alcohols and mild organic solvents
- Three types available: 1.0ml plates with round wells, and 1.6ml and 2.2ml plates with square wells
- Autoclavable
- Can be sealed with sealing film or silicone covers
- Conforms with the SBS standards for automation
- Compatible with automated DNA extraction equipment

Can be sealed with sealing film or silicone covers

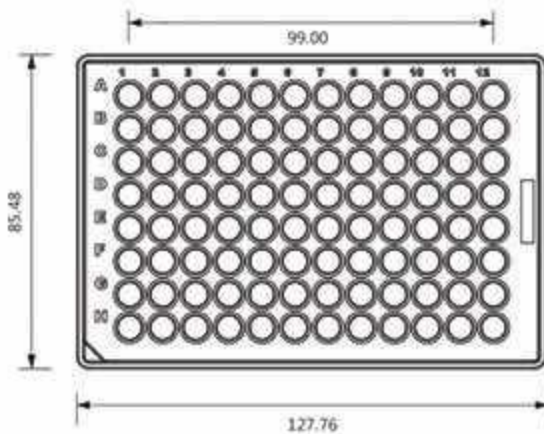
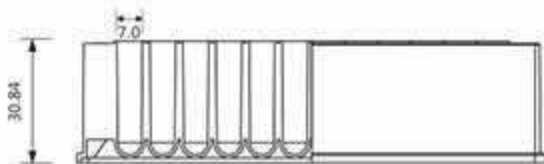
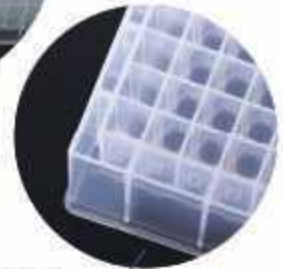
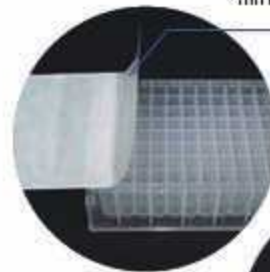

02-2010



Dimensions = mm

Molded alphanumeric labeling

Cat #	Description	Volume	Sterile	Unit	Total
02-2010	Round well	1.0ml	No	24 /Pack, 4 Packs/Case	96 /Case
02-1016	Square well	1.6ml	No	24 /Pack, 4 Packs/Case	96 /Case
02-1022	Square well	2.2ml	No	24 /Pack, 4 Packs/Case	96 /Case

Microplate Sealers



>> Features

- Made of High quality polypropylene, transparent polyester, hard polyester, impermeable aluminum foil, vinyl
- Well with not only PCR, qPCR, ELISA, inoculation and fluorescence experiment but also general and high throughput operation
- Applied to ELISA, inoculation, sample storage and microorganism cultivation sterile/ non-sterile
- Multiple temperature ranges are available, -80°C, -70°C, -40°C, -20°C, +80°C, 90°C, +100°C, +120°C
- Colored sealers with five options are available, green/purple/orange/red/blue
- Film-sealing paddle and plate roller are optional



Cat#	Material	Temperature range	Application	Sterile	Unit	Total
61-0010	Polypropylene	-40°C ~ +120°C	ELISA, inoculation	No	100 Pieces/Box	100 /Case
61-0020	Impermeable aluminum foil	-80°C ~+120°C	PCR, cold storage of sample	No	100 Pieces/Box	100 /Case
61-0040	Hard polyester	-40°C ~ +120°C	PCR, qPCR and sample storage	No	100 Pieces/Box	100 /Case
61-0041	Hard polyester	-40°C ~+120°C	PCR, qPCR and sample storage	No	100 pieces/Box	100 /Case
61-0051	Thick porous hydrophobic rayon	-20°C ~+80°C	biological culture	No	50 Pieces/Box	50 /Case
61-0060	Thick vinyl	-40°C ~ +90°C	automatic sampling	No	100 Pieces/Box	100 /Case
61-0080	DMSO resistant sealing foil	-80°C ~+120°C	PCR, photosensitive test and mechanical operation	No	100 Pieces/Box	100 /Case
61-0120	Hard polyester	-40°C ~ +120°C	ELISA, inoculation	Yes	2 Rolls/Box, 100 Pieces/Roll, equip with dispenser	200 /Case
61-0152	Thick porous hydrophobic rayon	-20°C ~+80°C	biological culture	Yes	2 Rolls/Box, 50 Pieces/Roll, equip with dispenser	100 /Case
61-0210	Polyolefin	-70°C ~ +100°C	qPCR, sample storage and protein crystallization	No	100 Pieces/Box	100 /Case
61-0303	Transparent polyester	-40°C ~+120°C	PCR, qPCR and sample storage	No	400 Pieces/Box	400 /Case
61-0304	Aluminum foil	-80°C ~ +120°C	PCR, sample storage photosensitive test, automatic operation	No	300 Strip/Box	300 /Case



>> Features

- Available in powder free latex and powder free nitrile
- Textured fingertips for an improved grip
Beaded cuff design helps users don gloves efficiently
- Extra length for increased protection
Biocompatibility tested (ISO 10993)
- Non-sterile



Nitrile material promotes better puncture



Extra-long cuffs

Cat #	Material	Size	Color	Unit	Total
97-1111	Latex	XS	Natural Off-White	100 /Pack, 10 Packs/Case	1000 /Case
97-1112	Latex	S	Natural Off-White	100 /Pack, 10 Packs/Case	1000 /Case
97-1113	Latex	M	Natural Off-White	100 /Pack, 10 Packs/Case	1000 /Case
97-1114	Latex	L	Natural Off-White	100 /Pack, 10 Packs/Case	1000 /Case
97-1115	Latex	XL	Natural Off-White	100 /Pack, 10 Packs/Case	1000 /Case
97-6111	Nitrile	XS	Dark Blue	100 /Pack, 10 Packs/Case	1000 /Case
97-6112	Nitrile	S	Dark Blue	100 /Pack, 10 Packs/Case	1000 /Case
97-6113	Nitrile	M	Dark Blue	100 /Pack, 10 Packs/Case	1000 /Case
97-6114	Nitrile	L	Dark Blue	100 /Pack, 10 Packs/Case	1000 /Case
97-6115	Nitrile	XL	Dark Blue	100 /Pack, 10 Packs/Case	1000 /Case



CryoKING Biobanking

CryoKING focus on core services of biobank comprehensive planning, biobank product supply and biobank systematic training, which continuously enhance systematic service ability. We are building a one-stop supply model featuring high automation degree, advanced modular function, perfect information layout, and full provision of hardware and software.



>> Features

- Made of medical grade polypropylene
- Can be repeatedly frozen and thawed
- Universal screw threads for use
- Tubes fit most common rotors
- Tubes fit standard 1-inch and 2-inch
- Autoclavable to 121°C and freezable to -86°C

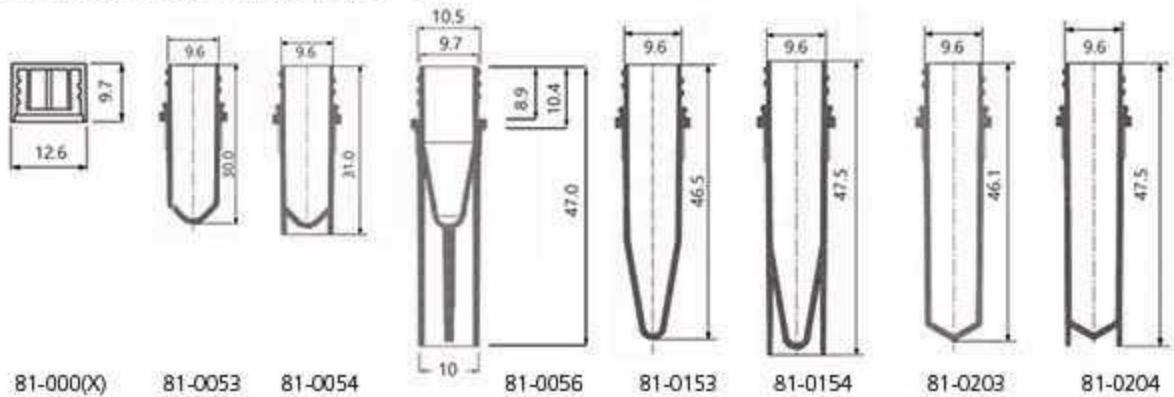

Dimensions = mm

Cat#	Type	Volume	Height	Color	Bottom	Sterile	Unit	Total
81-0053	Tubes	0.5ml	30.0	Clear	Conical	No	500 /Bag/Pack, 10 Packs/Case	5000 /Case
81-0054	Tubes	0.5ml	31.0	Clear	Self-Standing	No	500 /Bag/Pack, 10 Packs/Case	5000 /Case
81-0055	Tubes	0.5ml	47.5	Brown	Self-Standing	No	500 /Bag/Pack, 10 Packs/Case	5000 /Case
81-0056	Tubes	0.5ml	47.5	Clear	Self-Standing	No	500 /Bag/Pack, 10 Packs/Case	5000 /Case
81-0153	Tubes	1.5ml	46.5	Clear	Conical	No	500 /Bag/Pack, 10 Packs/Case	5000 /Case
81-0154	Tubes	1.5ml	47.5	Clear	Self-Standing	No	500 /Bag/Pack, 10 Packs/Case	5000 /Case
81-0203	Tubes	2.0ml	46.1	Clear	Conical	No	500 /Bag/Pack, 10 Packs/Case	5000 /Case
81-0204	Tubes	2.0ml	47.5	Clear	Self-Standing	No	500 /Bag/Pack, 10 Packs/Case	5000 /Case
81-0000	Caps	-	9.7	Clear	-	No	500 /Bag/Pack, 10 Packs/Case	5000 /Case
81-0001*	Caps	-	9.7	Pink	-	No	500 /Bag/Pack, 10 Packs/Case	5000 /Case
81-0002*	Caps	-	9.7	Green	-	No	500 /Bag/Pack, 10 Packs/Case	5000 /Case
81-0003*	Caps	-	9.7	Blue	-	No	500 /Bag/Pack, 10 Packs/Case	5000 /Case
81-0004*	Caps	-	9.7	Yellow	-	No	500 /Bag/Pack, 10 Packs/Case	5000 /Case
81-0005*	Caps	-	9.7	Assorted	-	No	500 /Bag/Pack, 10 Packs/Case	5000 /Case
81-0006	Caps	-	9.7	Brown	-	No	500 /Bag/Pack, 10 Packs/Case	5000 /Case

* Call for details.

Cryogenic Vials



81-8204

>> Features

- Made of medical grade polypropylene
- Autoclavable
- Can be repeatedly frozen and thawed
- Universal screw threads
- Vials fit most common rotors
- Vials fit standard 1-inch and 2-inch freezer boxes
- Gamma radiation sterilized
- DNase & RNase free, endotoxin free, and human DNA free
- 81-8204 2ml self-standing vials have a white writing area and black graduations

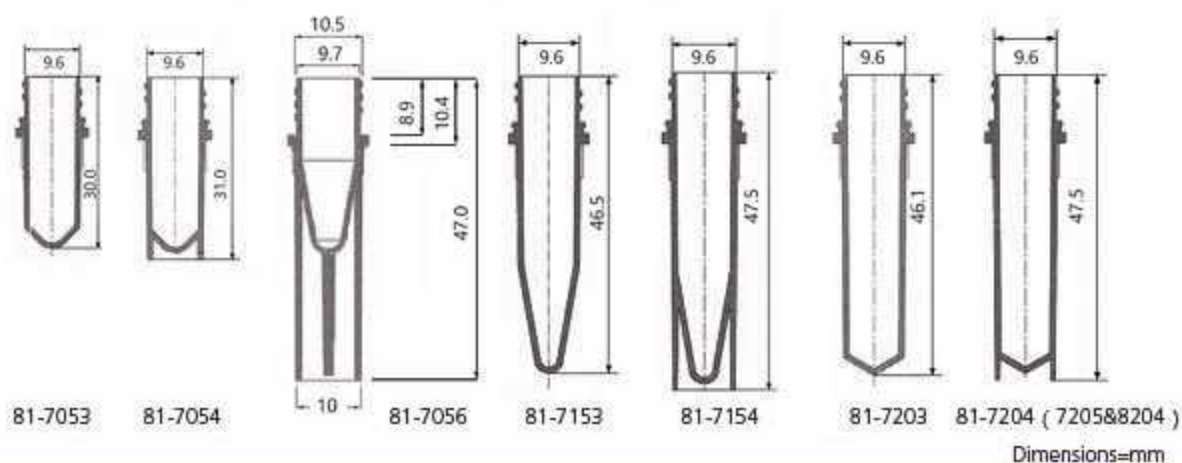

Dimensions=mm

Cat #	Volume	Color	Height	Bottom	Writing Area	Sterile	Unit	Total
81-7053*	0.5ml	Clear	30.0	Conical	No	Yes	50 /Bag, 10 Bags/Pack, 4 Packs/Case	2000 /Case
81-7054	0.5ml	Clear	31.0	Self-Standing	No	Yes	50 /Bag, 10 Bags/Pack, 4 Packs/Case	2000 /Case
81-7055	0.5ml	Brown	47.5	Self-Standing	No	Yes	50 /Bag, 10 Bags/Pack, 4 Packs/Case	2000 /Case
81-7056	0.5ml	Clear	47.5	Self-Standing	No	Yes	50 /Bag, 10 Bags/Pack, 4 Packs/Case	2000 /Case
81-7153	1.5ml	Clear	46.5	Conical	No	Yes	50 /Bag, 10 Bags/Pack, 4 Packs/Case	2000 /Case
81-7154	1.5ml	Clear	47.5	Self-Standing	No	Yes	50 /Bag, 10 Bags/Pack, 4 Packs/Case	2000 /Case
81-7203	2.0ml	Clear	46.1	Conical	No	Yes	50 /Bag, 10 Bags/Pack, 4 Packs/Case	2000 /Case
81-7204	2.0ml	Clear	47.5	Self-Standing	No	Yes	50 /Bag, 10 Bags/Pack, 4 Packs/Case	2000 /Case
81-7205	2.0ml	Brown	47.5	Self-Standing	No	Yes	50 /Bag, 10 Bags/Pack, 4 Packs/Case	2000 /Case
81-8204	2.0ml	Clear	47.5	Self-Standing	Yes	Yes	50 /Bag, 10 Bags/Pack, 4 Packs/Case	2000 /Case

* Call for details.



>> Features

- Made of medical grade polypropylene; Autoclavable; and can be repeatedly frozen and thawed
- 5ml cryogenic vials are available with external screw threads, and 2ml cryogenic vials are available with both external screw threads and internal screw threads. External thread screw vials' caps have no o-ring, which reduces the possibility of contamination
- Fit 9x9 (81-well) standard cryogenic boxes
- 7 different colored screw caps, tubes with black graduation printing, tubes top with white writing area, base with six corners, convenient to be operated
- Gamma radiations sterilized, RNase and DNase free, endotoxin free and foreign DNA free
- Pre-set 1D barcodes and numbers on sides for immediate scanning or visual identification
- 6 different colored markers: red, yellow, white, blue, purple, green

Specifications

- Working temperature: stable from -196°C to 121°C
- Suitable for liquid nitrogen freezing

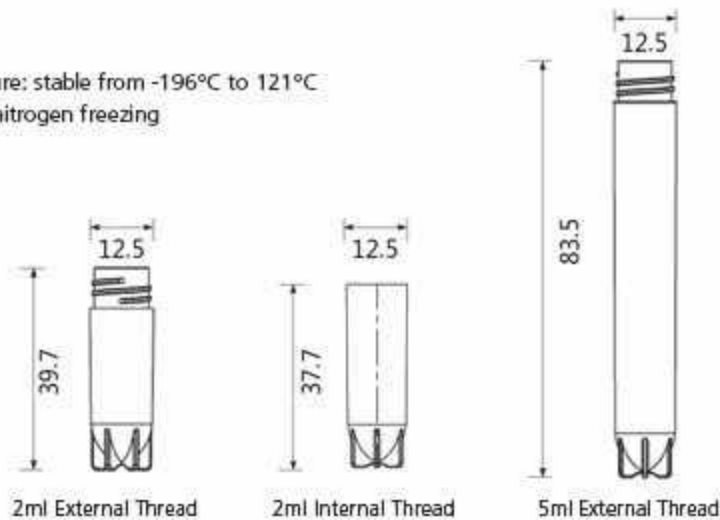

Dimensions=mm

Cat #	Type	Thread Type	Volume	Bottom	Side Barcode	Writing Area	Sterile	Unit	Total
88-621X	Tubes	Internal	2ml	Self-Standing	Yes	Yes	Yes	25 Sets/Bag, 40 Bags/Case	1000 Sets/Case
88-620X	Tubes	External	2ml	Self-Standing	Yes	Yes	Yes	25 Sets/Bag, 40 Bags/Case	1000 Sets/Case
88-650X	Tubes	External	5ml	Self-Standing	Yes	Yes	Yes	25 Sets/Bag, 40 Bags/Case	1000 Sets/Case
88-600X	Markers	-	-	-	-	-	-	100 Sets/Bag, 30 Bags/Case	3000 Sets/Case

X—Color of Caps : 0—White, 1—Red, 2—Green, 3—Blue, 4—Yellow*, 5—Purple, 7—Clear

* Call for details.

CryoKING Cryogenic Vials



>> Features

- Made of medical grade polypropylene, can be repeatedly frozen and thawed
- Vials have a white writing area and black graduations; 6 different colored caps are available
- Vials with pre-set Datamatrix 2D barcodes are available, and the 2D barcodes can be customized
- Use the microscopic imaging technique to pre-set 2D barcodes
- Gamma radiation sterilized, DNase & RNase free, endotoxin free, foreign DNA free
- Pre-set 1D barcodes and human readable numbers on sides for visual identification, and can be read by various scanners

Specifications

- Working temperature: stable from -196°C to 121°C
- Suitable for liquid nitrogen freezing

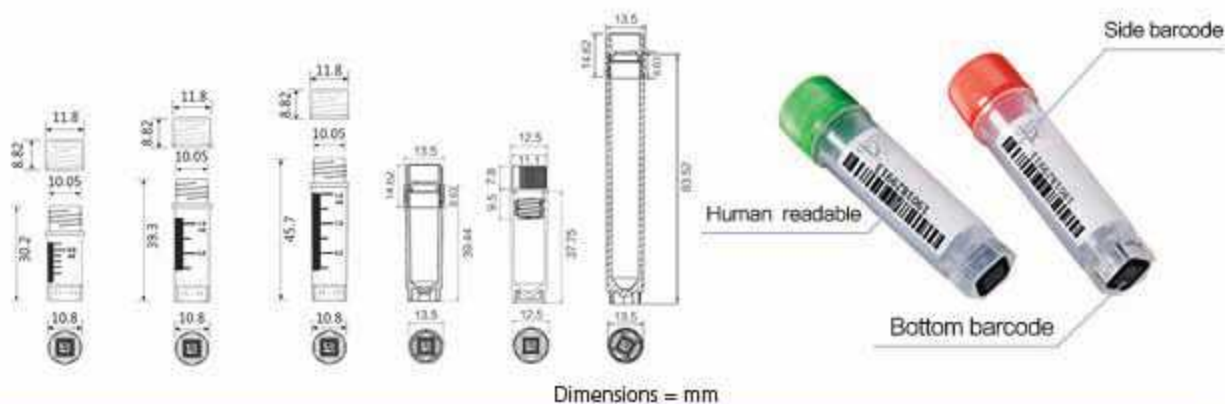

Cat #	Cat# (Upgrade with Side Barcode)	Thread Type	Volume	Bottom	Bottom Barcode	Writing Area	Sterile	Unit	Total
88-005X	88-605X	External	0.5ml	Self-Standing	No	Yes	Yes	25 Sets/Bag, 40 Bags/Case	1000 Sets/Case
88-010X	88-610X	External	1.0ml	Self-Standing	No	Yes	Yes	25 Sets/Bag, 40 Bags/Case	1000 Sets/Case
88-015X	88-615X	External	1.5ml	Self-Standing	No	Yes	Yes	25 Sets/Bag, 40 Bags/Case	1000 Sets/Case
88-020X	88-720X	External	2.0ml	Self-Standing	No	Yes	Yes	25 Sets/Bag, 40 Bags/Case	1000 Sets/Case
88-021X	88-721X	Internal	2.0ml	Self-Standing	No	Yes	Yes	25 Sets/Bag, 40 Bags/Case	1000 Sets/Case
88-050X	88-750X	External	5.0ml	Self-Standing	No	Yes	Yes	25 Sets/Bag, 40 Bags/Case	1000 Sets/Case
-	88-905X	External	0.5ml	Self-Standing	Yes	Yes	Yes	25 Sets/Bag, 40 Bags/Case	1000 Sets/Case
-	88-910X	External	1.0ml	Self-Standing	Yes	Yes	Yes	25 Sets/Bag, 40 Bags/Case	1000 Sets/Case
-	88-915X	External	1.5ml	Self-Standing	Yes	Yes	Yes	25 Sets/Bag, 40 Bags/Case	1000 Sets/Case
-	88-920X	External	2.0ml	Self-Standing	Yes	Yes	Yes	25 Sets/Bag, 40 Bags/Case	1000 Sets/Case
-	88-921X	Internal	2.0ml	Self-Standing	Yes	Yes	Yes	25 Sets/Bag, 40 Bags/Case	1000 Sets/Case
-	88-950X	External	5.0ml	Self-Standing	Yes	Yes	Yes	25 Sets/Bag, 40 Bags/Case	1000 Sets/Case

X---Cap Color : 0-White, 1-Rad, 2-Green, 3-Blue, 4-Yellow, 5-Purple, 7-Clear

Call for details.

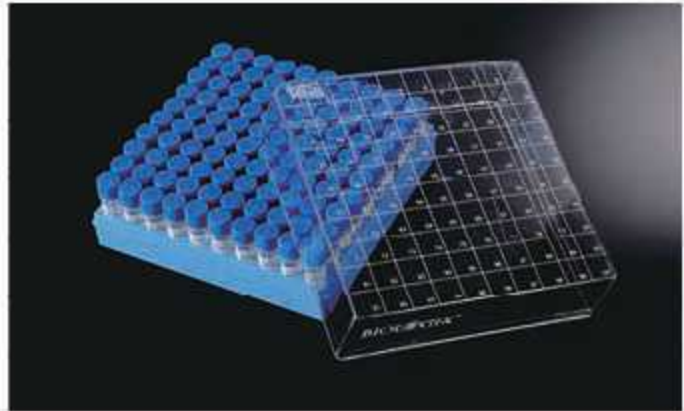
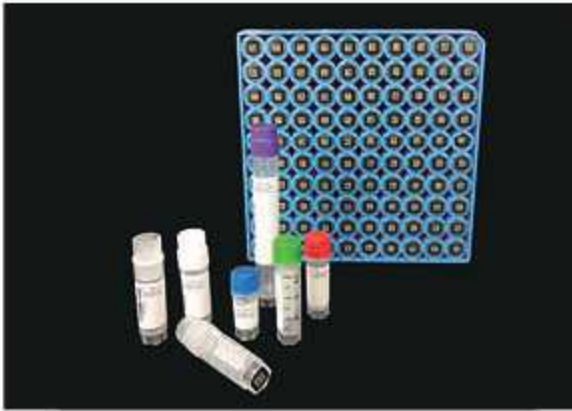

>> Features

- All you need in one package:
 - CryoKING Vials with pre-set 2D barcodes
 - Pre-assembled inside the CryoKING Boxes
 - Pre-sterilized
- Certified: foreign DNA free, DNase & RNase free, endotoxin free
- Rapidly scans and identifies an entire box full of vials
- Pre-set 1D barcodes and numbers on side for immediate scanning or visual identification.

Specifications

- Working temperature: stable from -196°C to 121°C
- Suitable for liquid nitrogen freezing

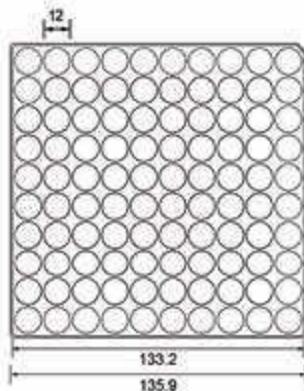

89-905X/89-910X/89-915X

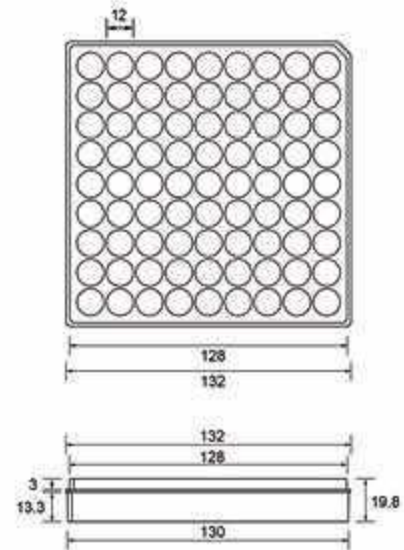
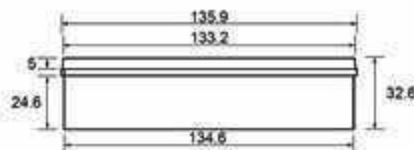

89-920X/89-921X/89-950X

Dimensions = mm

Cat #	Volume	Bottom barcode	Side Code	Wells	Thread Type	Dimensions(mm)	Unit	Total
89-905X	0.5ml Vials + 1 inBox	Yes	Yes	100-well	External	133x133x36	6 Bags/Pack , 2 Packs/Case	12 Bags/Case
89-910X	1.0ml Vials + 2 inBox	Yes	Yes	100-well	External	133x133x52	6 Bags/Pack , 2 Packs/Case	12 Bags/Case
89-915X	1.5ml Vials + 2 inBox	Yes	Yes	100-well	External	133x133x52	6 Bags/Pack , 2 Packs/Case	12 Bags/Case
89-922X	2.0ml Vials + 2 inBox	Yes	Yes	100-well	External	136x136x52	6 Bags/Pack , 2 Packs/Case	12 Bags/Case
89-923X	2.0ml Vials + 2 inBox	Yes	Yes	100-well	Internal	136x136x52	6 Bags/Pack , 2 Packs/Case	12 Bags/Case
89-920X	2.0ml Vials + 2 inBox	Yes	Yes	81-well	External	133x133x52	6 Bags/Pack , 2 Packs/Case	12 Bags/Case
89-921X	2.0ml Vials + 2 inBox	Yes	Yes	81-well	Internal	133x133x52	6 Bags/Pack , 2 Packs/Case	12 Bags/Case
89-950X	5.0ml Vials + 3.75 inBox	Yes	Yes	81-well	External	133x133x95	6 Bags/Pack , 2 Packs/Case	12 Bags/Case

X--Cap Color : 0-White,1-Red,2-Green,3-Blue,4-Yellow*,5-Purple,7-Clear

* Call for details.

Automated Product Series of SBS Standards



>> Features

- 2D barcodes on 96-well format cryogenic vials are easy to be read
- 2D barcode and human-readable numbers on the side of SBS format racks; 2D barcode at the bottom of racks, cryogenic vials and racks can be traced at the same time
- Simple yet powerful mechanical locking function and slide the buttons on both sides to unlock
- Laser etched 2D barcodes, resistant to DMSO and other organic solvents
- SBS format rack fits 96-well format cryogenic vials perfectly for automatic operations

Specifications

- Working temperature: stable from -196°C to 121°C
- Suitable for liquid nitrogen freezing



96-well SBS Cryogenic Vials

Cat #	Thread Type	Volume	Bottom	Bottom Barcode	Writing Area	Sterile	Unit	Total
88-403X	Internal	300µl	Self-Standing	Yes	No	Yes	96 Sets/Bag, 10 Bags/Pack, 2 Packs/Case	1920 Sets/Case
88-405X	Internal	500µl	Self-Standing	Yes	No	Yes	96 Sets/Bag, 10 Bags/Pack, 2 Packs/Case	1920 Sets/Case
88-408X	Internal	750µl	Self-Standing	Yes	No	Yes	96 Sets/Bag, 10 Bags/Pack, 2 Packs/Case	1920 Sets/Case
88-410X	Internal	1000µl	Self-Standing	Yes	No	Yes	96 Sets/Bag, 10 Bags/Pack, 2 Packs/Case	1920 Sets/Case

X-Cap Color : 0-White, 1-Red, 2-Green, 3-Blue, 4-Yellow, 5-Purple

SBS Format Cryogenic Racks

Cat #	Vial Volume	Wells	Color	Dimensions(mm)	Unit	Total
98-4117	300µl & 500µl	96-well, round	Blue	128x85x35	10 /Pack , 2 Packs/Case	20 /Case
98-4217	750µl & 1000µl	96-well, round	Blue	128x85x54	10 /Pack , 2 Packs/Case	20 /Case
98-4127	300µl & 500µl	96-well, square	White	128x85x35	10 /Pack , 2 Packs/Case	20 /Case
98-4227	750µl & 1000µl	96-well, square	White	128x85x54	10 /Pack , 2 Packs/Case	20 /Case

SBS Format Combo

Cat #	Description	Bottom Barcode	Side Barcode	Wells	Dimensions(mm)	Unit
89-403X	300µl Vials+Rack	Yes	No	96-well, round	128x85x35	1 Sets/Bag , 10 Bags/Pack , 2 Packs/Case
89-405X	500µl Vials+Rack	Yes	No	96-well, round	128x85x35	1 Sets/Bag , 10 Bags/Pack , 2 Packs/Case
89-408X	750µl Vials+Rack	Yes	No	96-well, round	128x85x54	1 Sets/Bag , 10 Bags/Pack , 2 Packs/Case
89-410X	1000µl Vials+Rack	Yes	No	96-well, round	128x85x54	1 Sets/Bag , 10 Bags/Pack , 2 Packs/Case
89-423X	300µl Vials+Rack	Yes	No	96-well, square	128x85x35	1 Sets/Bag , 10 Bags/Pack , 2 Packs/Case
89-425X	500µl Vials+Rack	Yes	No	96-well, square	128x85x35	1 Sets/Bag , 10 Bags/Pack , 2 Packs/Case
89-428X	750µl Vials+Rack	Yes	No	96-well, square	128x85x54	1 Sets/Bag , 10 Bags/Pack , 2 Packs/Case
89-421X	1000µl Vials+Rack	Yes	No	96-well, square	128x85x54	1 Sets/Bag , 10 Bags/Pack , 2 Packs/Case

X-Cap Color : 0-White , 1-Red , 2-Green , 3-Blue , 4-Yellow , 5-Purple

Premium Cardboard Cryogenic Boxes



>> Features

- Made of durable cardboard with superior white outer coating
- Chemically resistant to alcohols and mild organic solvents
- Five assorted colors available: white, yellow, pink, blue, and green
- White Premium Cardboard Freezer Boxes have a glossy coating, other colors have a matte coating
- Water resistant coating for improved durability
- Superior white 90-1281 & 90-1200 cardboard cryogenic boxes without outer coating are also available
- Holds 0.5ml, 1.5ml, 2.0ml, 5ml and 10ml microtubes and 15ml or 50ml Centrifuge Tubes

Specifications

- Working temperature: stable from -196°C to 121°C
- Suitable for liquid nitrogen freezing

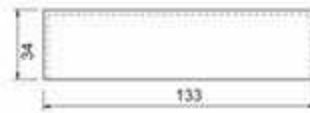
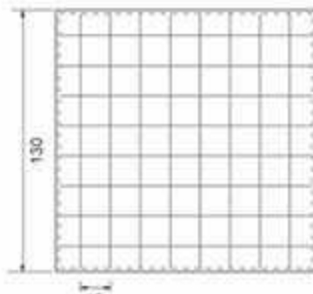

90-2281

Dimensions = mm

Cat #	Height	Wells	Description	Dimensions (mm)	Unit	Total
90-1200	2 in	100-well	Superior white without outer coating	132 x 132 x 53	5/Bag, 20 Bags/Case	100 /Case
90-1281	2 in	81-well	Superior white without outer coating	132 x 132 x 53	5/Bag, 20 Bags/Case	100 /Case
90-1300	2 in	100-well	Superior white without outer coating	133 x 133 x 76	5/Bag, 20 Bags/Case	100 /Case
90-1381	2 in	81-well	Superior white without outer coating	133 x 133 x 76	5/Bag, 20 Bags/Case	100 /Case
90-2281	2 in	81-well	White coating, plastic coating	133 x 133 x 52	5/Bag, 20 Bags/Case	100 /Case
90-2200	2 in	100-well	White coating, plastic coating	133 x 133 x 52	5/Bag, 20 Bags/Case	100 /Case
90-5281	2 in	81-well	Rainbow outer coating, matte coating	133 x 133 x 52	5/Bag, 20 Bags/Case	100 /Case
90-5200	2 in	100-well	Rainbow outer coating, matte coating	133 x 133 x 52	5/Bag, 20 Bags/Case	100 /Case
90-2381	3 in	81-well	White coating, plastic coating	133 x 133 x 76	5/Bag, 20 Bags/Case	100 /Case
90-2300	3 in	100-well	White coating, plastic coating	133 x 133 x 76	5/Bag, 20 Bags/Case	100 /Case

ID-Color™ Cardboard Cryogenic Boxes



>> Features

- Made of durable cardboard with a waterproof coating and polypropylene dividers
- Hinged lid design ensures that lids are never misplaced or mixed up
- Alphanumeric labeling featured on the lid, bottom, and four sides enables quick and easy identification of samples
- Holds 0.5ml/1.5ml/2.0ml/5.0ml microtubes and cryogenic vials

Specifications

- Suitable for liquid nitrogen freezing (after adding vent holes, and using cardboard dividers)

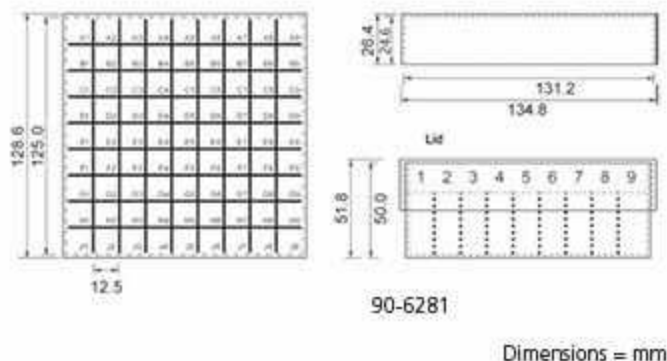

Post-style dividers



Straight grid divider design, resistant to low temperature

Cat #	Height	Well	Divider Material	Dimensions (mm)	Unit	Total
90-8100	1in	100-well	PP	133 x 133 x 36	5 /Bag, 4 Bags/Case	20 /Case
90-8281	2in	81-well	PP	133 x 133 x 52	5 /Bag, 4 Bags/Case	20 /Case
90-8200	2in	100-well	PP	133 x 133 x 52	5 /Bag, 4 Bags/Case	20 /Case
90-8381	3.75in	81-well	PP	133 x 133 x 95	5 /Bag, 4 Bags/Case	20 /Case

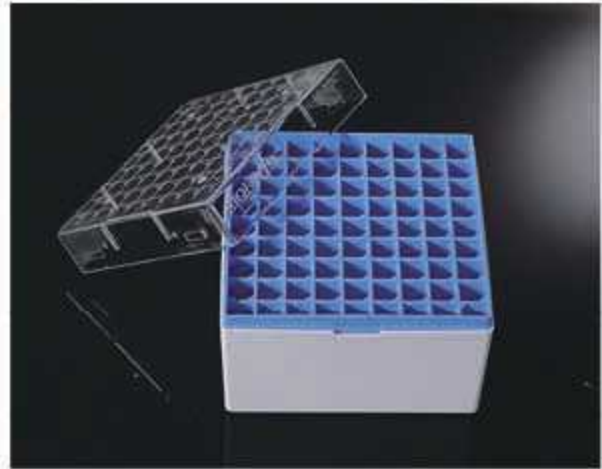

>> Features

- Made of tough polycarbonate, chemically resistant to alcohols and mild organic solvents
- Can be repeatedly frozen and thawed
- 5x5 (25-well), 9x9 (81-well), or 10x10 (100-well) boxes available
- Compatible with 0.5ml, 1.5ml, 2.0ml or 5.0ml microtubes and cryogenic vials
- Boxes feature numbered grids for sample identification
- Drain holes and air vents minimize condensation
- Five assorted colors available

Specifications

- Suitable for storage in mechanical freezers or liquid nitrogen
- Temperature range: stable from -196°C to 121°C

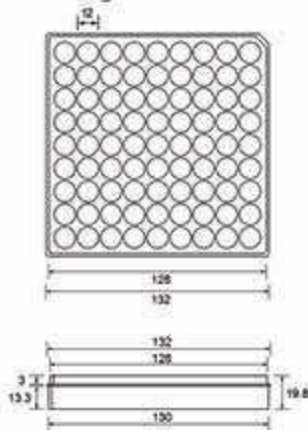
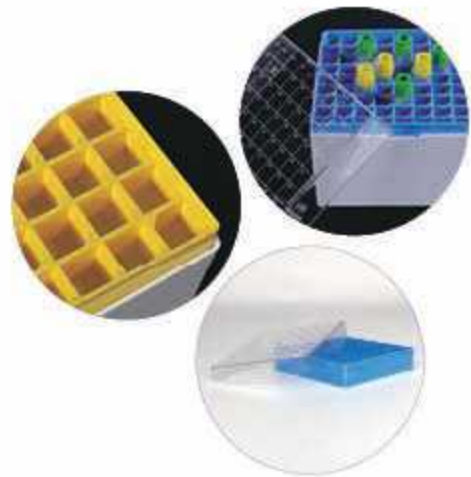

90-9009/90-9381/98-0313/98-1213

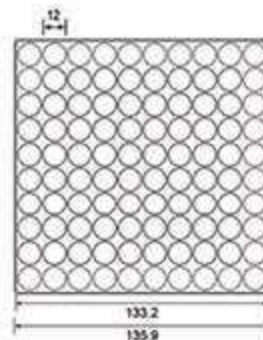

98-0113/98-0213/90-9210/98-0200

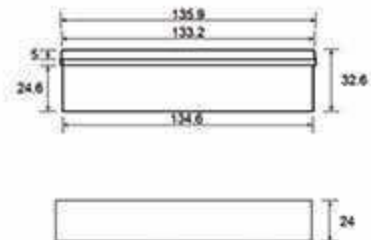

Cat #	Height	Wells	Color	Dimensions (mm)	Unit	Total
90-9009	2 in	81-well	Assorted Colors	133x133x52	5 /Bag, 4 Bags/Case	20 /Case
90-9210	2 in	100-well	Assorted Colors	133x133x52	5 /Bag, 4 Bags/Case	20 /Case
90-9250	2 in	25-well	Assorted Colors	75x75x52	5 /Bag, 6 Bags/Case	30 /Case
90-9381	3.75 in	81-well	Assorted Colors	133x133x95	5 /Bag, 4 Bags/Case	20 /Case
98-0113	1 in	100-well	Blue	133x133x36	3 /Bag, 4 Bags/Case	12 /Case
98-0200	2 in	100-well	Blue	136x136x52	3 /Bag, 4 Bags/Case	12 /Case
98-0213	2 in	100-well	Blue	133x133x52	3 /Bag, 4 Bags/Case	12 /Case
98-0313	3.75 in	81-well	Blue	133x133x95	3 /Bag, 4 Bags/Case	12 /Case
98-1213	2 in	81-well	Blue	133x133x52	3 /Bag, 4 Bags/Case	12 /Case

PP Cryogenic Boxes

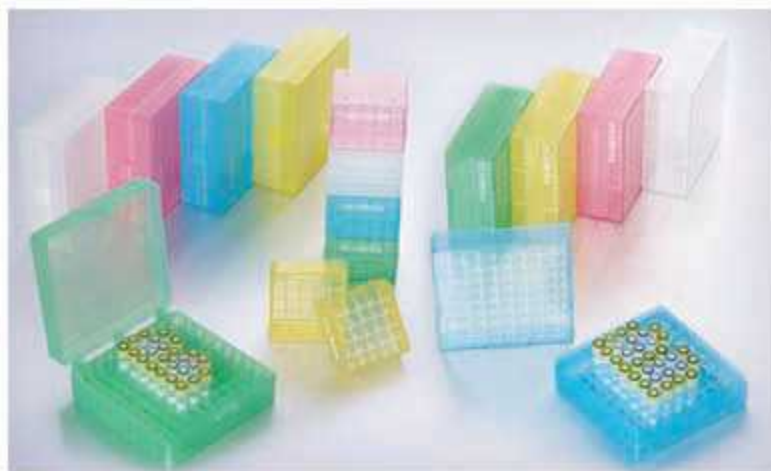

>> Features

- Made of polypropylene, chemically resistant to alcohols and mild organic solvents
- Can be repeatedly frozen and thawed
- 5x5 (25-well), 9x9 (81-well), or 10x10 (100-well) boxes available
- Compatible with 0.5ml, 1.5ml or 2.0ml microtubes and cryogenic vials
- Boxes feature numbered grids for sample identification
- Drain holes and air vents minimize condensation
- Five assorted colors available

Specifications

- Suitable for storage in mechanical freezers
- Temperature range: stable from -86°C to 121°C



Number grid for sample identification



Convenient sample organization

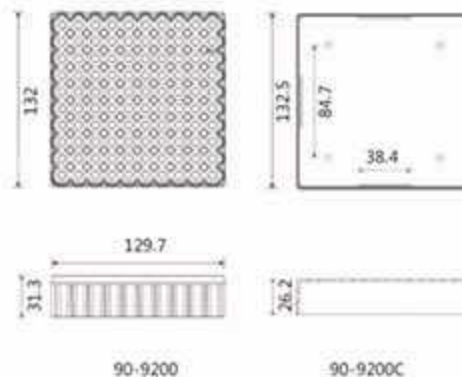

90-9200

90-9200C

Dimensions = mm

Cat #	Height	Wells	Color	Dimensions (mm)	Unit	Total
90-9025	2 in	25-well	Assorted Colors	75 x 75 x 52	5 /Bag, 6 Bags/Case	30 /Case
90-9081	2 in	81-well	Assorted Colors	133 x 133 x 52	5 /Bag, 4 Bags/Case	20 /Case
90-9100	2 in	100-well	Assorted Colors	141 x 154 x 55	5 /Bag, 4 Bags/Case	20 /Case
90-9200	2 in	100-well	Assorted Colors	133 x 133 x 52	5 /Bag, 4 Bags/Case	20 /Case



Sliding Drawer Freezer Racks

- Made of corrosion-resistant stainless steel or aluminium alloy
- Ideal for storage of 1 inch and 2 inch standard size cryogenic boxes
- Fits most standard upright freezers
- Sliding Drawer Freezer Racks include folded rails to reduce frost
- Flanging design reduces scratching
- Handle design enables easy removal from the shelf
- Colored labels for drawer/sample identification
- Special sliding drawer freezer racks can be customized

Cat #	Texture of material	Description	Capacity (D x H Configuration)	Dimensions(mm) (D x W x H)	Storage box size (mm)
99-7216	Stainless steel	Sliding Drawer Freezer Racks	4 x 4	564 x 141 x 229	133 x 133 x 52
99-7220	Stainless steel	Sliding Drawer Freezer Racks	4 x 5	564 x 141 x 285	133 x 133 x 52
99-7224	Stainless steel	Sliding Drawer Freezer Racks	4 x 6	564 x 141 x 341	133 x 133 x 52
99-7128	Stainless steel	Sliding Drawer Freezer Racks	4 x 7	564 x 141 x 285	133 x 133 x 36
96-7216	Aluminium alloy	Sliding Drawer Freezer Racks	4 x 4	564 x 141 x 231	133 x 133 x 52
96-7220	Aluminium alloy	Sliding Drawer Freezer Racks	4 x 5	564 x 141 x 288.5	133 x 133 x 52
96-7224	Aluminium alloy	Sliding Drawer Freezer Racks	4 x 6	564 x 141 x 346	133 x 133 x 52



Side Access Drawer Freezer Racks

- Made of corrosion-resistant stainless steel
- Ideal for storage of 1 inch and 2 inch standard size cryogenic boxes
- Fits most standard upright freezers
- Special sliding drawer freezer racks can be customized

Cat #	Texture of material	Description	Capacity (D x H Configuration)	Dimensions(mm) (D x W x H)	Storage box size (mm)
99-5216	Stainless steel	Side Access Drawer Freezer Racks	4 x 4	560 x 140 x 240	133 x 133 x 52
99-5220	Stainless steel	Side Access Drawer Freezer Racks	4 x 5	560 x 140 x 300	133 x 133 x 52

Freezer Racks



Frame Type Freezer Racks

- Made of corrosion-resistant stainless steel or aluminium alloy
- Ideal for storage of 1 inch and 2 inch standard size cryogenic boxes
- Fits most standard upright freezers
- Simple structure and lightweight design helps manage cryogenic boxes efficiently
- Special sliding drawer freezer racks can be customized

Cat #	Texture of material	Description	Capacity (D x H Configuration)	Dimensions (mm) (D x W x H)	Storage box size (mm)
96-2216	Aluminium alloy	Frame Type Freezer Racks	4 x 4	552 x 137 x 228	133 x 133 x 52
96-2220	Aluminium alloy	Frame Type Freezer Racks	4 x 5	552 x 137 x 284	133 x 133 x 52
96-2224	Aluminium alloy	Frame Type Freezer Racks	4 x 6	552 x 137 x 340	133 x 133 x 52
99-2120	Stainless steel	Frame Type Freezer Racks	4 x 5	560 x 137 x 204	133 x 133 x 36
99-2124	Stainless steel	Frame Type Freezer Racks	4 x 6	560 x 137 x 244	133 x 133 x 36
99-2216	Stainless steel	Frame Type Freezer Racks	4 x 4	560 x 137 x 229	133 x 133 x 52
99-2220	Stainless steel	Frame Type Freezer Racks	4 x 5	560 x 137 x 284	133 x 133 x 52
99-2224	Stainless steel	Frame Type Freezer Racks	4 x 6	560 x 137 x 339	133 x 133 x 52



Vertical Type Freezer Racks

- Made of corrosion-resistant stainless steel or aluminium alloy
- Ideal for storage of 1 inch and 2 inch standard size cryogenic boxes
- Fits most standard upright freezers
- Especially suitable for liquid nitrogen freezing
- Special sliding drawer freezer racks can be customized

Cat #	Texture of material	Description	Capacity (D x H Configuration)	Dimensions (mm) (D x W x H)	Storage box size (mm)
99-62XX	Stainless steel	Vertical Type	1 x X	* x 140 x 140	133 x 133 x 52
96-62XX	Aluminium alloy	Vertical Type	1 x X	* x 139 x 140	133 x 133 x 52

X (Capacity /L) 06, 07, 08, 09, 10, 11, 12, 13 * (Depth /mm) 338, 394, 450, 506, 562, 618, 674, 730



8-Channel



96-Channel

>> Features

8-Channel Screw Cap Capper/Decapper

- Easy-to-use design: Caps or decaps 8 tubes in an individual line
- Convenient operation: Improves processing throughput of manual procedures with automated column-wise decapping and capping in just three seconds
- Optimal torque level: Ensures reproducibility by capping/decapping all tubes to the optimal torque level
- Ergonomic design: Allows anyone in the lab to cap or decap tubes with a light weight, easy-to-use and ergonomic design
- Extra-long standby time: Enhances the convenience of actual operation
- Low noise: Enables the capping/decapping noise less than 5 decibels

96-Channel Screw Cap Capper/Decapper

Specifications

- External dimension (L*W*H) : 450mm*320mm*430mm
- Voltage: 110-220VAC
- Electric current: 6A
- Power: 600W
- Control source: DC 24V/5A
- Opening time of whole board: 12S
- Closing time of whole board: 12S



Cat#	Lithium battery capacity	Continual operation	Standby time	8-Channel screw cap capping/Decapping	External dimension(L*W*H)
CKS-1008	5500MA	8H	30 Days	3S	95mm*46mm*255mm

Cat#	Power	Control source	Opening time of whole board	Closing time of whole board	External dimension(L*W*H)
CKS-1096	600W	DC 24V/5A	12S	12S	450mm*320mm*430mm

CryoKING Tube Handling System



>> Features

- Re-array, reformat or cherry pick tubes
- Weigh tubes (tare & gross weights)
- Detect volume with the LevelCheck
- 2D Barcode decoding
- LIMS integration ready
- Work list based operation
- Efficient for both small and large projects
- Label printer and applicator option
- Designed for continuous use and unattended operation
- Encoder based robotics and precision bearings provide the highest reliability
- Integration software toolkits available

Ordering Information

- Electrical: 110–220 VAC 50/60Hz
- Operating Environment: 10°C to 40°C , 10–90% RH [Standard]; -4°C to 40°C , 10–90% RH [Cold Room Model]
- System Requirements: Windows 10, 8, 7 – 2 GB RAM Recommended – USB 2.0 ports



Weigh Tubes

Re-array, reformat tubes



Label Printing and Application

Decode 2D barcodes



Cat #	Capacity	Modules	Dimensions (mm)	Weight
CKS-1520	20 SBS Racks	Standard: Re-array, reformat tubes; Decode 2D barcodes, weigh tubes	72 x 53 x 40 cm	27 kg
CKS-152X	20 SBS Racks	Optional: Level check, DMSO hydration check, label, enclosure	Depend on modules	Depend on modules



CryoKING Handheld Scanner

- Infrared scanning individual cryogenic vials to identify barcodes and 2D barcodes accurately
- Ergonomic handheld design
- Compatible with CryoKING Crown biobanking management software
- Collect sample information rapidly and accurately



Wireless Handheld Scanner Gun

- Can scan linear and 2D barcodes
- Ergonomic, lightweight design
- Wireless, pairs with a computer or mobile device using Bluetooth
- Compatible with our CryoScan app for Windows, Android, and iOS, as well as many other barcode scanning programs



CryoKING Scanner-1.0

- Can scan 200 samples in 5 seconds
- Equipped with 2-Box Scanning frame for free
- Equipped with PC software for free, and can be paired with international database, such as SQL server, Oracle, MySQL, Postgres, HSQL
- Access with CryoKING Crown biobanking management software, and samples information can be collected rapidly and accurately



CryoKING Scanner-3.0

- Scans one rack in less than 1 second
- Advanced error handling options
- Operates down to -20°C
- Compatible with most cryogenic boxes of major brands
- Project based workflow for easy rack type changes
- Detects missing tubes
- Advanced error handling options

Cat #	Description	Scan Type
CKS-0101	Wired Handheld Scanner Gun	Individual Vial
CKS-0201	Wireless Handheld Scanner Gun	Individual Vial
CKS-1101	AC 100-240V/50Hz/60Hz	Entire Box
CKS-1301	AC 100-240V/50Hz/60Hz	Entire Box

Biobanking Management Software

The CryoKING Crown Biobanking Management Software integrates everything from sample management and storage to packaging and transport into one comprehensive management program. It is the tool of choice for streamlined scientific research and biobanking management.

>> Features

- Can be accessed through the CryoKING Cloud service, or hosted locally for use on a laboratory's own LAN
- Designed for use with industry-standard equipment and procedures
- Easy-to-use Interface allows users to upload and import existing sample data
- Compatible with CryoKING Scanner-1.0 and Scanner-3.0 for entire box of individual 2D-barcoded cryogenic vials
- Currently available in English and Simplified Chinese (more languages coming soon)

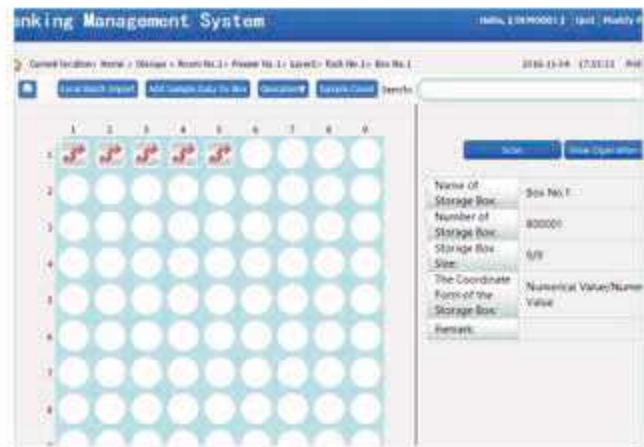

1. Our products (including freezer racks, cryogenic boxes, and cryogenic vials, with more to come) are designed with to be compatible with standard-size equipment and to be suitable for the storage of many types of samples.

2. The Crown visual interface displays a visual representation of every level of a lab's sample storage from freezers to individual samples, allowing users to review their sample storage status at a glance.

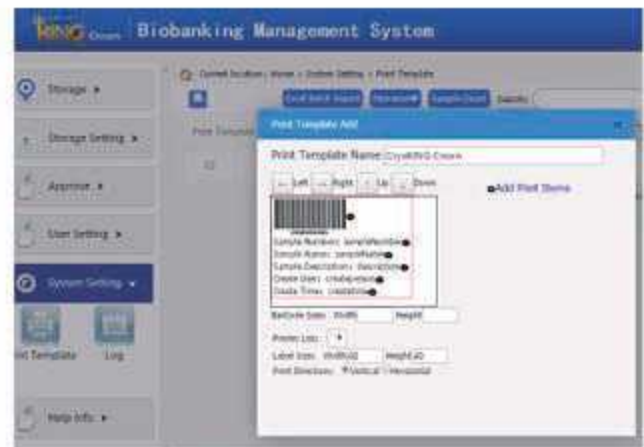

3. Icons and templates can be customized to suit each lab's needs, and custom images can be uploaded for use as icons.

4. Transition seamlessly from your previous system by importing your data into the Crown system using Excel or CSV files.

Ultra Low Freezers- Large volume series



CKF-UL678 / 778 / 858 / 1008

>> Features

Intelligence Microcontroller

- High precision computer temperature controller, platinum Resistance Temperature sensor, $-10^{\circ}\text{C} \sim -86^{\circ}\text{C}$ can be set freely
- 7inch touch screen controller, easy operation and better controlling precision

Security System

- Audible and visual alarm (high or low temperature, door open, power failure alarm, sensor fault, low battery, poor heat dissipation of condenser, system failure alarm),
- Delayed start and safe stop interval ensure reliable operation
- Keyboard lock and password protected configuration page
- Double lock design ensures secure sample storage

Refrigeration System

- New generation of cryogenic refrigeration technology to provide quick freezer and lower consumption
- Imported high efficiency compressor and EBM fan motor, strong power and energy efficiency
- Double foam insulated door, multi-patent insulation design of outer door system
- six sides of the body adopt high performance vacuum insulation material

Humanization Design

- High strength adjustable shelf: three brackets fixed, strong bearing capacity, good stability
- Special document box, make record more convenient
- Stainless steel interior (SUS304), long service life and easy cleaning
- Brand new power door handle, can be operated by one hand easily
- Front chassis panel: condenser filter can be cleaned easily
- USB data storage function, can be download and inquire by computer
- Fixed foot design: universal castor + fixed foot design, easy to move and fix
- Optional: chart recorder, backup battery, alarm lamp, voltage compensation, remote monitor system, CO2 backup system

Matching Biobank

- Optimized design of the middle body, special for biobanking storage

Cat#	Capacity	Input Power	Temperature	External Size (WxDxH mm)	Internal Size (WxDxH mm)	Weight (Kg)
CKF-UL678	678	1450	$-10 \sim -86^{\circ}\text{C}$	1090*1025*1955	750*696*1286	330
CKF-UL778	778	1450	$-10 \sim -86^{\circ}\text{C}$	1205*1025*1955	865*696*1286	380
CKF-UL858	858	1825	$-10 \sim -86^{\circ}\text{C}$	1217*1025*2005	877*696*1378	390
CKF-UL1008	1008	1900	$-10 \sim -86^{\circ}\text{C}$	1362*1025*2002	1022*696*1378	430

Ultra Low Freezers- Energy Saving Series



CKF-UL398 / 528

>> Features

Energy Saving and Environmental Protection

- CAS environment-friendly refrigeration technology
- Unique refrigeration circuit with independent intellectual property rights
- Strong refrigeration capacity by unipolar compressor oil-lubricated technology
- Imported high efficiency compressor and EBM fan motor, strong power and energy efficiency
- Double foam insulated door, multi-patent insulation design of outer door system
- The body adopt high performance vacuum heat insulation material

Control System

- 7inch touch screen controller, clear display and easy operation
- High precision computer temperature controller, platinum resistance temperature sensor
- -10℃ ~ -86℃ inside the body can be set freely

Security System

- Audible and visual alarm (high or low temperature, door open, power failure alarm, sensor fault, low battery, poor heat dissipation of condenser, system failure alarm)
- Delayed start and safe stop interval ensure reliable operation
- Keyboard lock and password protected configuration page
- Double lock design ensures secure sample storage

Humanization Design

- Narrow type door: slim figure, flexible enter and exit
- High strength adjustable shelf: three brackets fixed, strong bearing capacity, good stability
- Special document box, make record more convenient
- Stainless steel interior (SUS304), long service life and easy cleaning
- Brand new power door handle, can be operated by one hand easily
- Front chassis panel: condenser filter can be cleaned easily
- USB data storage function, can be download and inquire by computer
- Fixed foot design: universal wheel and fixed foot design, easy to move and fix
- Optional: chart recorder, backup battery, alarm lamp, voltage compensation, remote monitor system, CO2 backup system

Matching Biobank

- Optimized design of the middle body, special for biobanking storage

Cat#	Capacity	Input Power	Temperature	External Size (WxDxH,mm)	Internal Size (WxDxH,mm)	Weight (Kg)
CKF-UL398	398	980	-10 ~ -86℃	785*1041*1947	440*696*1266	252
CKF-UL528	528	1050	-10 ~ -86℃	930*1041*1947	585*696*1266	286

Ultra Low Freezers- Medium and Small Volume Series



>> Features

Control System

- High precision computer temperature controller, platinum resistance temperature sensor
- $-10^{\circ}\text{C} \sim -86^{\circ}\text{C}$ inside the body can be set freely

Security System

- Audible and visual alarm (high or low temperature, door open, power failure alarm, sensor fault, low battery, poor heat dissipation of condenser, system failure alarm)
- Sample storage is safer
- Delayed start and safe stop interval ensure reliable operation
- Keyboard lock and password protected configuration page
- Double lock design ensures secure sample storage

Humanization Design

- Rotate power handle for flexible opening (The door of Chest type: balanced hinge opening)
- Adjustable rack structure for easy storage (Only Vertical Type)
- Double door design for better heat insulation effect (Only Vertical Type)
- Optional: chart recorder, backup battery, alarm lamp, voltage compensation, remote monitor system, CO₂ backup system
- Stainless steel interior (SUS304), long service life and easy cleaning (Vertical Type)
- Universal wheel and fixed foot design, easy to move and fix (Vertical Type)

Cat#	Capacity	Input Power	Temperature	External Size (WxDxH mm)	Internal Size (WxDxH mm)	Weight (Kg)
CKF-UW138	138	860	$-10 \sim -86^{\circ}\text{C}$	1320*890*1009	490*470*570	205
CKF-UW328	328	1050	$-10 \sim -86^{\circ}\text{C}$	2005*890*1009	1200*470*570	280
CKF-UW438	438	1050	$-10 \sim -86^{\circ}\text{C}$	2005*890*1009	1270*590*540	296
CKF-UL100	100	850	$-10 \sim -86^{\circ}\text{C}$	1066*742*820	450*439*514	145
CKF-UL290	290	1040	$-10 \sim -86^{\circ}\text{C}$	755*846*1797	470*588*1047	226
CKF-UL340	340	1080	$-10 \sim -86^{\circ}\text{C}$	755*895*1982	470*578*1250	240
CKF-UL508	508	1000*2	$-10 \sim -86^{\circ}\text{C}$	1200*897*1999	880*504*Up570Down514	385
CKF-UL538	538	1850	$-10 \sim -86^{\circ}\text{C}$	842*989*2023	662*600*1344	298
CKF-UL540	540	1900	$-10 \sim -86^{\circ}\text{C}$	840*918*1984	600*730*1330	306
CKF-UL668	668	1965	$-10 \sim -86^{\circ}\text{C}$	1137*989*1994	815*666*1215	347

-40 Ultra Low Freezers



>> Features

Refrigeration System

- Fluorine-free refrigerant, imported famous brand compressor, EBM fan motor
- Unique refrigeration circuit with independent intellectual property rights
- Double foam insulated door, multi-patent insulation design of outer door system
- The body adopt high performance vacuum heat insulation material

Control System

- High precision computer temperature controller, platinum resistance temperature sensor
- Digital temperature display, keep track of running status
- $-10^{\circ}\text{C} \sim -40^{\circ}\text{C}$ inside the body can be set freely
- Double compressor for separate room control (only double room)

Security System

- Audible and visual alarm (high or low temperature, door open, power failure alarm, sensor fault, low battery, poor heat dissipation of condenser, system failure alarm)
- Delayed start and safe stop interval ensure reliable operation
- Keyboard lock and password protected configuration page
- Double lock design ensures secure sample storage

Humanization Design

- Rotate power handle for flexible opening (The door of Chest type: balanced hinge opening)
- Adjustable rack structure for easy storage (Only Vertical Type)
- Stainless steel interior, anticorrosive phosphating spraying
- Double door design for better heat insulation effect (Only Vertical Type)
- Low noise design, create comfortable working environment

Cat#	Capacity	Input Power (W)	Capacity	External Size (WxDxH mm)	Internal Size (WxDxH mm)	Weight (Kg)
CKF-CL090	90	182	$-10 \sim -40^{\circ}\text{C}$	540*558*898	410*420*675	43
CKF-CL270	270	430	$-10 \sim -40^{\circ}\text{C}$	600*640*1750	435*410*1545	80
CKF-CL450	450	700	$-10 \sim -40^{\circ}\text{C}$	780*660*1850	640*515*675	136
CKF-CL531	531	1250	$-10 \sim -40^{\circ}\text{C}$	842*989*1999	662*600*1345	250



>> Features

Control System

- Microprocessor-based temperature controller: high sensitivity sensor
- Automatic temp. control: display accuracy 0.1℃ , 2 ~ 8℃ inside adjustable
- Intelligent forced air circulation system

Security System

- Audible and visual alarm (door open, sensor failure alarm, high and low temperature alarm)
- Delayed start and lockable door to protect sample safety
- Delayed start and safe stop interval ensure reliable operatio

Refrigeration System

- Fluorine-free refrigent, imported famous brand compressor
- High effective air-cooled condenser to provide quick freezing

Humanization Design

- Stainless steel interior, anticorrosive phosphating spraying
- Internal wall is ABS engineering plastic
- Double transparent insulated glass door filled with inert gas
- Caster are mounted under the bottom
- Adjustable shelves made of quality steel wire
- With backup battery and temperature recorder (CKF-M520/M968/M1500)

Cat#	Capacity	Input Power	Temperature	External Size (WxDxH mm)	Internal Size (WxDxH mm)	Weight (Kg)
CKF-M260	260	215	2 ~ 8℃	603*590*1556	515*380*1110	72
CKF-M300	300	215	2 ~ 8℃	603*590*1728	515*380*1282	74
CKF-M520	520	460	2 ~ 8℃	710*840*1980	590*675*1445	120
CKF-M728	728	530	2 ~ 8℃	1180*670*2025	1083*546*1182	142
CKF-M968	968	650	2 ~ 8℃	1200*798*1965	1080*630*1420	180
CKF-M1500	1500	960	2 ~ 8℃	1800*798*1965	1680*640*1420	240

Ultra-low Temperature Liquid Nitrogen Tanks-Biobank Series



CKD-V035S013



CKD-V045S013



CKD-V180S013

>> Features

- Available for vapor and liquid phase
- Available in different capacities
- Small footprint and large capacity to reduce storage cost
- Stable temperature control
- Advanced temperature monitoring system, liquid level monitoring system and alarming system
- Automatic liquid nitrogen filling system
- The microprocessor system keeps data and information forever
- Demist button
- Special design for convenient operation
- Lockable lid to ensure the safety of samples
- Integral foldable steps and operation platform
- CE certified

Cat #	Capacity (L)	Neck Diameter (mm)	Inner Usable Height (mm)	Outer Diameter (mm)	Height (mm)	Max. Storage Capacity of 2ml Cryogenic Vials	Max. Blood Bag Holding Capacity	Maximum Load
CKD-V035S013	350	326	600	875	1326	13000	1296	502
CKD-V045S013	460	326	828	875	1558	18200	1728	649
CKD-V055S013	587	445	600	1104	1321	26000	2376	802
CKD-V075S013	783	445	828	1104	1591	36400	3168	1005
CKD-V085S013	890	465	773	1190	1559	42900	3360	1160
CKD-V100S013	1014	465	900	1190	1704	49500	4320	1314
CKD-V130S013	1340	635	620	1565	1398	58500	4716	1934
CKD-V160S013	1660	635	791	1565	1589	76050	5502	2255
CKD-V180S013	1880	635	900	1565	1883	87750	7074	2504
CKD-V180S014	1880	635	900	1565	1883	94875	7758	2504

Ultra-low Temperature Liquid Nitrogen Tanks-Laboratory Series



>> Features

- Made of durable aluminum alloy
- Racks and boxes are available
- Large capacity and low energy consumption
- Locked-lid switch, liquid level monitoring system and carrying cart are available
- CE certified
- Vacuum warranty: 5 years
- Designed for long-term storage
- Labeled racks and boxes for sample identification and orientation
- Liquid level monitoring system is optional and it will send out sound and light for alarm when the liquid reaches low level



Cat #	Geometric Capacity (L)	Neck Diameter (mm)	Number of Cryogenic Vials	Static Evaporation Loss Rate (LD)	Static Holding Time (D)
CKS-L010Q125	10	125	100	0.42	24
CKS-L030Q125	30	125	600	0.33	90
CKS-L035Q125	35	125	750	0.36	97
CKS-L047W127	47	127	750	0.36	130
CKS-L065Q216	65	216	2400	0.78	83
CKS-L095Q216	95	216	3000	0.97	98
CKS-L115Q216	115	216	3600	0.94	122
CKS-L175Q216	175	216	6000	0.95	184

Ultra-low Temperature Liquid Nitrogen Tanks-Portable Dewar and Static Storage Series



>> Features

- High-strength light aluminum alloy
- Protective holding bag
- Low evaporation
- Numerical canisters for orientation
- Lockable-lid switch is available
- CE certified
- Vacuum warranty: 5 years

Cat#	Geometric capacity (L)	Neck diameter (mm)	Static evaporation loss rate (L/Day)	Static holding time (Day)	Height(mm)	Outer diameter(mm)	Empty weight(kg)
CKS-P302Z030	2	30	0.07	28	399	223	2.8
CKS-P302Z035	2	35	0.08	24	428	204	2.6
CKS-P603Z050	3	50	0.12	26	435	223	3.1
CKS-P606Z050	6	50	0.12	52	482	300	4.8
CKS-P610Z050	10	50	0.12	86	552	300	6.1

Cell Culture Series

Cell culture involves sampling cells from an organism, placing these cells in an in vitro environment, and observing the growth, reproduction, aging or other processes of the cells. Cell culture has become an important practice in life science research, and plays a central role in the development of the biotechnology industry.

The Biologix Cell Culture Series offers a range of safe and reliable basic supplies for cell transfer, filtering, and other applications.



Cell Culture Flasks



>> Features

- Made of high quality medical grade polystyrene
- Available flask sizes include surface areas of 25 cm², 75 cm², or 175 cm²
- Plug cap and filter cap options available for all flask sizes
- Plug caps completely isolate the culture from the outside environment
- Filter caps prevent cross-contamination while meeting the requirements for gas exchange
- Short, wide, angled neck design for easy access
- Gamma radiation sterilized
- Non-pyrogenic, non-cytotoxic
- DNase & RNase free, human DNA free

Suitable for open culture conditions, effectively preventing cross-contamination while meeting therequirements for gas exchange in cell and tissue culture

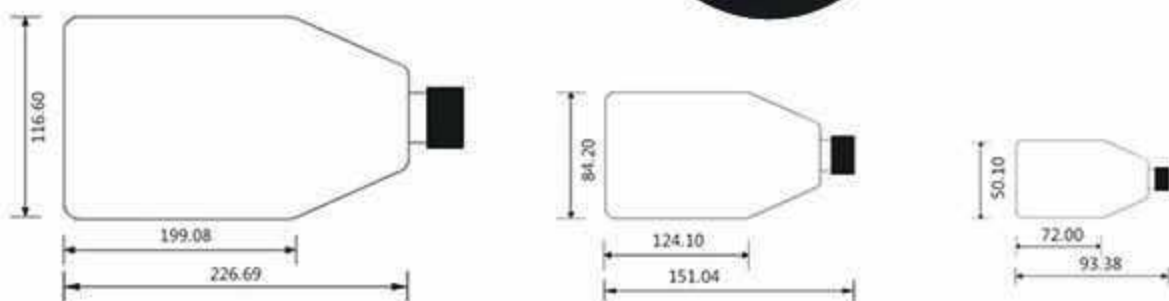

Dimensions = mm

Cat #	Cap Type	Culture Area	Working Volume	Total Volume	Surface Treatment	Sterile	Unit	Total
07-8025	Filter	25cm ²	7ml	60 ml	Yes	Yes	5 /Bag, 40 Bags/Case	200 /Case
07-8075	Filter	75cm ²	25ml	250ml	Yes	Yes	5 /Bag, 20 Bags/Case	100 /Case
07-8175	Filter	175cm ²	50ml	650ml	Yes	Yes	5 /Bag, 8 Bags/Case	40 /Case
07-9025	Plug	25cm ²	7ml	60ml	Yes	Yes	5 /Bag, 40 Bags/Case	200 /Case
07-9075	Plug	75cm ²	25ml	250ml	Yes	Yes	5 /Bag, 20 Bags/Case	100 /Case
07-9175	Plug	175cm ²	50ml	650ml	Yes	Yes	5 /Bag, 8 Bags/Case	40 /Case

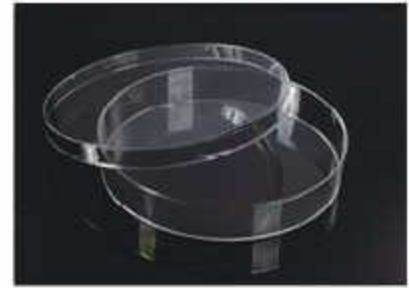

>> Features

- Made of high quality medical grade polystyrene
- Lid design promotes effective gas exchange
- External grip for easier handling (07-3035 and 07-3060)
- Raised edges for convenient stacking
- Vacuum plasma surface treatment ensures excellent cell adhesion
- Smooth, transparent materials facilitate observation of cells through a microscope
- Electron beam sterilized
- Non-pyrogenic, non-cytotoxic
- DNase & RNase free, human DNA free

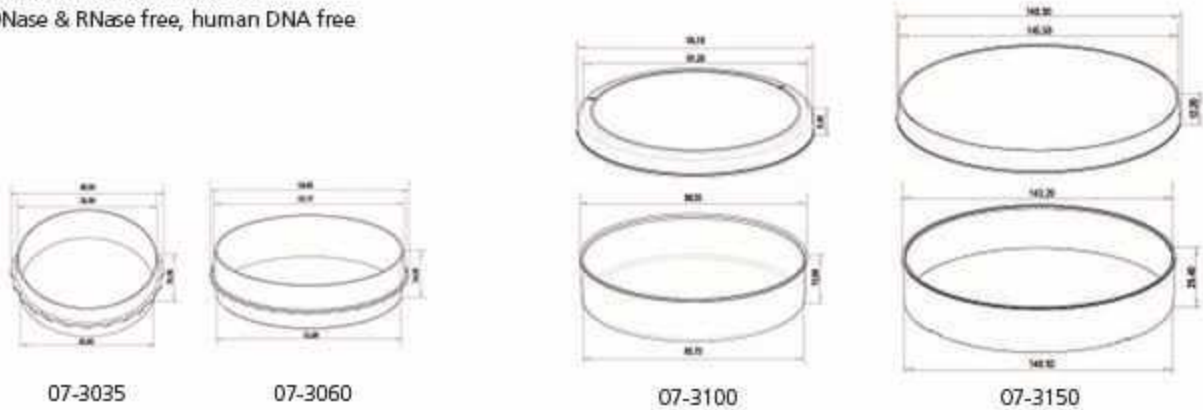

Dimensions = mm

Cat #	Dish style D x H (mm)	Internal Dimensions D x H (mm)	Culture Area	Working Volume	External Grip	Sterile	Unit
07-3035	35.00 x 10.00	34.30 x 9.30	9.40cm ²	3.00ml	Yes	Yes	10 /Bag, 500 /Case
07-3060	60.00 x 15.00	52.80 x 12.80	21.50cm ²	5.00ml	Yes	Yes	10 /Bag, 500 /Case
07-3100	90.00 x 20.00	86.26 x 17.70	57.50cm ²	12.50ml	No	Yes	10 /Bag, 200 /Case
07-3150	150.00 x 25.00	140.20 x 23.30	148.00cm ²	35.00ml	No	Yes	10 /Bag, 120 /Case

Cell Culture Plates



>> Features

- Constructed of prime virgin polystyrene
- Plate cover design minimizes the risk of cross contamination
- Thin-walled well bottoms increase thermal consistency, reducing the edge effect
- Flat well bottoms provide excellent clarity for microscopic examination of samples
- Gamma radiation sterilized
- Non-pyrogenic, non-cytotoxic
- DNase & RNase free, human DNA free

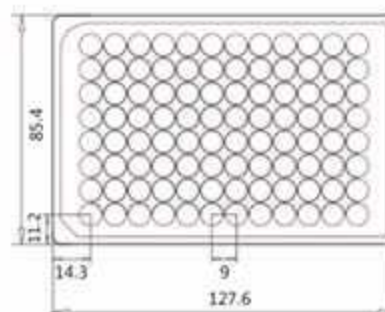
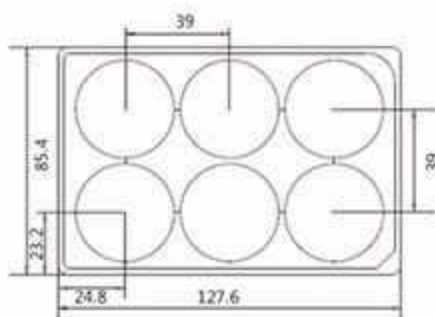

Dimensions = mm

Cat. #	Wells	External Dimensions W x L x H (mm)	Well Dimensions D x H (mm)	Culture Area	Working Volume	Sterile	Unit
07-6006	6-well	85.40 x 127.60 x 20.20	35.00 x 17.50	9.6cm ²	3ml	Yes	1/Bag, 50 Bags/Case
07-6012	12-well	85.40 x 127.60 x 20.20	21.90 x 17.50	3.8cm ²	2ml	Yes	1/Bag, 50 Bags/Case
07-6024	24-well	85.40 x 127.60 x 20.20	15.50 x 17.50	1.9cm ²	1ml	Yes	1/Bag, 50 Bags/Case
07-6048	48-well	85.40 x 127.60 x 20.20	9.75 x 17.50	0.75cm ²	0.5ml	Yes	1/Bag, 50 Bags/Case
07-6096	96-well	85.40 x 127.60 x 14.40	6.50 x 10.80	0.33cm ²	0.2ml	Yes	1/Bag, 50 Bags/Case

Serological Pipettes



>> Features

- Constructed of highly transparent prime virgin polystyrene
- Available in 1ml, 2ml, 5ml, 10ml, 25ml, 50ml volumes
- Each volume labeled with a different color for ease of use
- Ascending and descending graduations
- Filter at the top of each pipette prevents damage to pipettors
- Electron beam sterilized
- Non-pyrogenic, non-cytotoxic
- DNase & RNase free, human DNA free

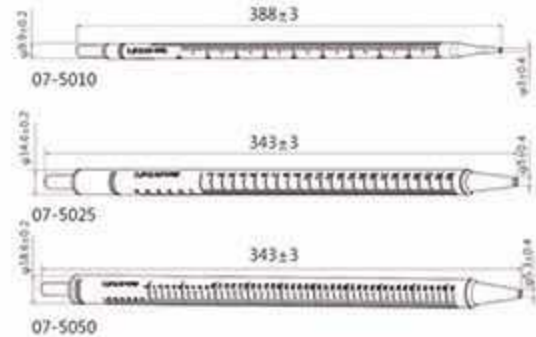
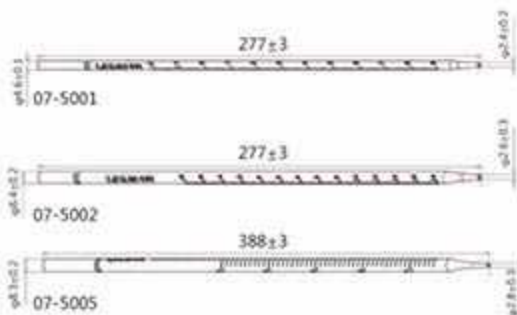

Dimensions = mm

Cat #	Working Volume	Color	Sterile	Unit	Total
07-5001	1.00ml	Yellow	Yes	1 /Bag, 200 Bags/Pack, 4 Packs/Case	800 /Case
07-5002	2.00ml	Green	Yes	1 /Bag, 150 Bags/Pack, 4 Packs/Case	600 /Case
07-5005	5.00ml	Blue	Yes	1 /Bag, 100 Bags/Pack, 4 Packs/Case	400 /Case
07-5010	10.00ml	Orange	Yes	1 /Bag, 100 Bags/Pack, 4 Packs/Case	400 /Case
07-5025	25.00ml	Red	Yes	1 /Bag, 50 Bags/Pack, 4 Packs/Case	200 /Case
07-5050	50.00ml	Purple	Yes	1 /Bag, 40 Bags/Pack, 4 Packs/Case	160 /Case

Cell Culture Slides

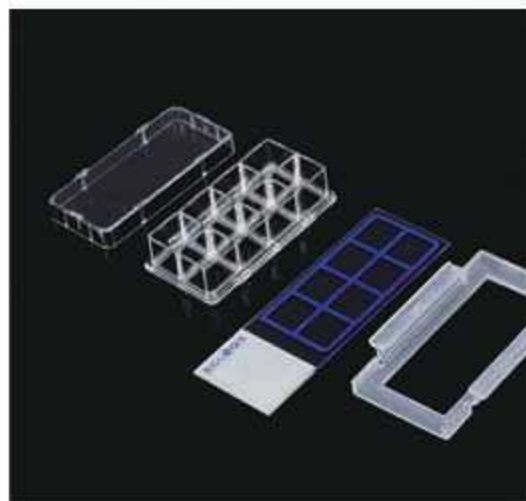
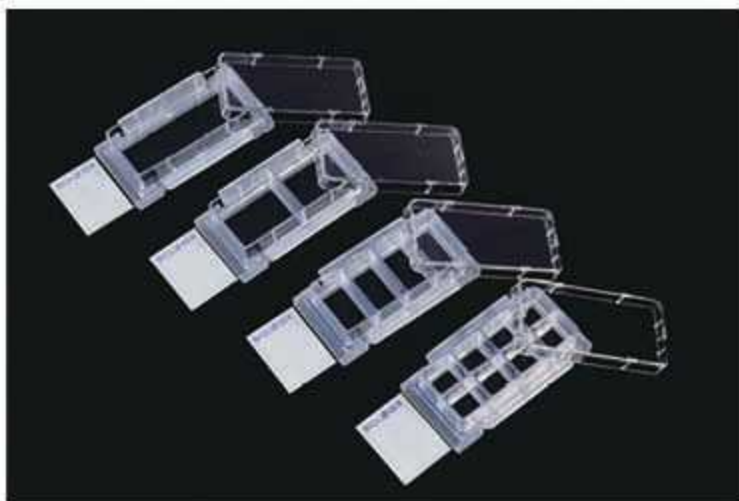

>> Features

- Easy-to-open, highly transparent slide chambers
- Chamber numbering for convenient sample identification
- Polystyrene chamber piece available with 1, 2, 4, or 8 wells
- Packing trays can be used as incubation racks in CO₂ incubators
- Slide and chamber apparatus can be easily disassembled without damaging samples
- EO Sterilized

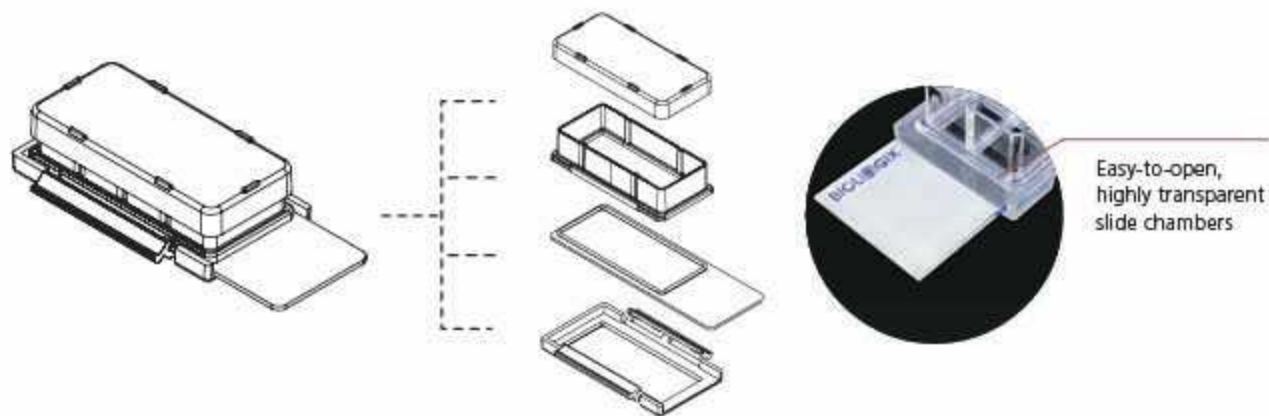

Cat #	Material Chamber/Slide/Holder	Wells	Color	Growth Area	Working	Sterile	Unit	Total
07-2101	PS /Glass/PP	1-well	Clear	9.40cm ²	2.50-5.50ml	Yes	6 /Pack, 2 Packs/Case	12 /Case
07-2102	PS /Glass/PP	2-well	Clear	4.55cm ²	1.20-2.50ml	Yes	6 /Pack, 2 Packs/Case	12 /Case
07-2104	PS /Glass/PP	4-well	Clear	2.13cm ²	0.50-1.30ml	Yes	6 /Pack, 2 Packs/Case	12 /Case
07-2108	PS /Glass/PP	8-well	Clear	0.98cm ²	0.20-0.60ml	Yes	6 /Pack, 2 Packs/Case	12 /Case



>> Features

- Made of sturdy polypropylene and strong nylon mesh
- Three different pore sizes available: 40µm, 70µm, or 100µm
- Strainers are color-coded according to pore size for convenience
- Fits perfectly into Biologix 50ml Centrifuge Tubes
- Gamma radiation sterilized, non-pyrogenic

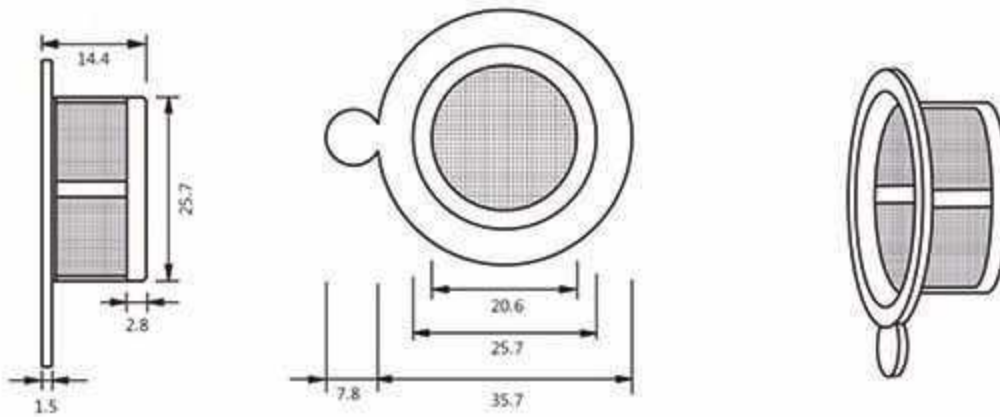

Dimensions = mm

Cat #	Size	Color	Sterile	Package	Unit	Total
15-1040	40µm	Purple	Yes	Individual	1 /Bag, 100 Bags/Case	100 /Case
15-1070	70µm	Orange	Yes	Individual	1 /Bag, 100 Bags/Case	100 /Case
15-1100	100µm	Green	Yes	Individual	1 /Bag, 100 Bags/Case	100 /Case

Cell Scrapers & Lifters

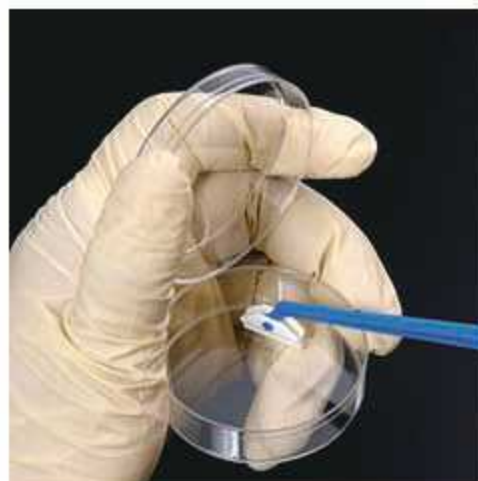

>> Features

Cell Scrapers

- Made of polyethylene
- Available in two sizes: 18cm or 25cm in length,
- Pivoting blade makes precise cutting and scraping movements
- Gamma radiation sterilized, non-pyrogenic

Cell Lifters

- Made of polyethylene
- One-piece design and chiseled blade provide improved control while minimizing damage to cells
- Gamma radiation sterilized, non-pyrogenic

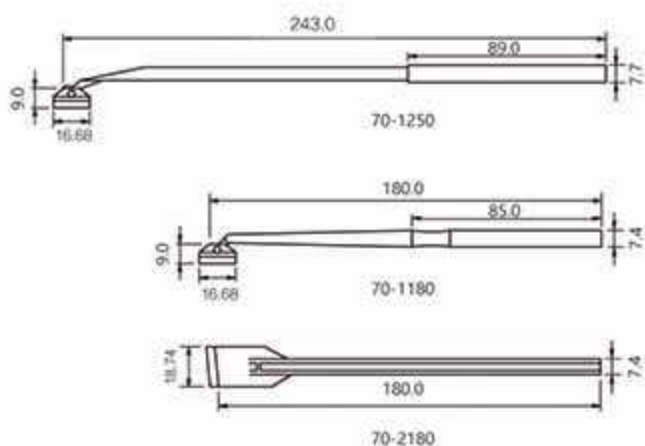

Dimensions = mm

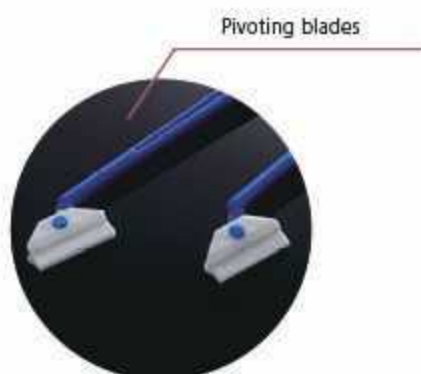

Cat #	Name	Handle Length	Sterile	Package	Unit	Total
70-2180	Cell Lifter	18cm	Yes	Individual	1 /Bag, 100 Bags/Case	100 /Case
70-1180	Cell Scraper	18cm	Yes	Individual	1 /Bag, 100 Bags/Case	100 /Case
70-1250	Cell Scraper	24.3cm	Yes	Individual	1 /Bag, 200 Bags/Case	200 /Case

PCR Series

PCR (polymerase chain reaction) is a technique used in molecular biology to amplify a segment of DNA, and is commonly used in both clinical and research laboratories for many applications, including DNA sequencing, diagnosis of hereditary diseases, and more. The Biologix PCR Series includes a variety of PCR tubes and plates suitable for standard PCR experiments.

PCR Tubes



>> Features

- Made of high quality medical grade polypropylene
- Ultra thin-wall tubes provide faster heating and cooling
- High degree of transparency allows for easy observation of samples
- Available with domed caps or flat caps
- Domed caps ensure efficient heat transfer
- Flat caps are ideal for Real-Time PCR (qPCR)
- Unique cap design prevents opening during cycling and incubation stages
- DNase, RNase, and endotoxin free

Specifications

- Fits most standard thermocyclers
- Can withstand centrifugation of up to 6,000 RCF

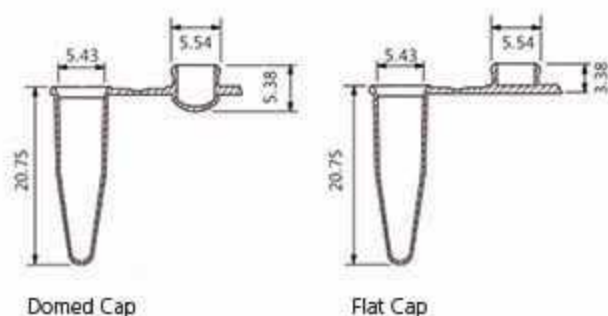

Dimensions = mm

Cat #	Volume	Color	Cap	Sterile	Unit	Total
60-0082	0.2ml	Clear	Flat-top	No	1,000 /Bag/Pack, 10 Packs/Case	10000 /Case
60-0182*	0.2ml	Pink	Flat-top	No	1,000 /Bag/Pack, 10 Packs/Case	10000 /Case
60-0282*	0.2ml	Green	Flat-top	No	1,000 /Bag/Pack, 10 Packs/Case	10000 /Case
60-0382*	0.2ml	Blue	Flat-top	No	1,000 /Bag/Pack, 10 Packs/Case	10000 /Case
60-0482*	0.2ml	Yellow	Flat-top	No	1,000 /Bag/Pack, 10 Packs/Case	10000 /Case
60-0002	0.2ml	Clear	Dome-shaped	No	1,000 /Bag/Pack, 10 Packs/Case	10000 /Case
60-0102*	0.2ml	Pink	Dome-shaped	No	1,000 /Bag/Pack, 10 Packs/Case	10000 /Case
60-0202*	0.2ml	Green	Dome-shaped	No	1,000 /Bag/Pack, 10 Packs/Case	10000 /Case
60-0302*	0.2ml	Blue	Dome-shaped	No	1,000 /Bag/Pack, 10 Packs/Case	10000 /Case
60-0402*	0.2m	Yellow	Dome-shaped	No	1,000 /Bag/Pack, 10 Packs/Case	10000 /Case

* Call for details.



>> Features

- Made of high quality medical grade polypropylene
- Ultra thin-wall tubes provide faster heating and cooling
- High degree of transparency allows for easy observation of samples
- Available with domed caps or flat caps
- Domed caps ensure efficient heat transfer
- Flat caps are ideal for Real-Time PCR (qPCR)
- Unique cap design prevents opening during cycling and incubation stages

Specifications

- Fits most standard thermocyclers
- Can withstand centrifugation of up to 6,000 RCF
- Packaged in resealable bags

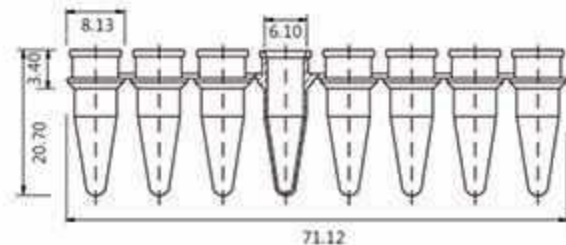

Dimensions = mm

Cat#	Volume	Color	Cap Type	Sterile	Unit
60-0088	0.2ml	Clear	Flat	No	125 Strip Tubes+125 Strip Caps/Bag/Pack, 10 Packs/Case; 1250 sets/Case
60-0188*	0.2ml	Pink	Flat	No	125 Strip Tubes+125 Strip Caps/Bag/Pack, 10 Packs/Case; 1250 sets/Case
60-0288*	0.2ml	Green	Flat	No	125 Strip Tubes+125 Strip Caps/Bag/Pack, 10 Packs/Case; 1250 sets/Case
60-0388*	0.2ml	Blue	Flat	No	125 Strip Tubes+125 Strip Caps/Bag/Pack, 10 Packs/Case; 1250 sets/Case
60-0488*	0.2ml	Yellow	Flat	No	125 Strip Tubes+125 Strip Caps/Bag/Pack, 10 Packs/Case; 1250 sets/Case
60-0008	0.2ml	Clear	Domed	No	125 Strip Tubes+125 Strip Caps/Bag/Pack, 10 Packs/Case; 1250 sets/Case
60-0108*	0.2ml	Pink	Domed	No	125 Strip Tubes+125 Strip Caps/Bag/Pack, 10 Packs/Case; 1250 sets/Case
60-0208*	0.2ml	Green	Domed	No	125 Strip Tubes+125 Strip Caps/Bag/Pack, 10 Packs/Case; 1250 sets/Case
60-0308*	0.2ml	Blue	Domed	No	125 Strip Tubes+125 Strip Caps/Bag/Pack, 10 Packs/Case; 1250 sets/Case
60-0408*	0.2ml	Yellow	Domed	No	125 Strip Tubes+125 Strip Caps/Bag/Pack, 10 Packs/Case; 1250 sets/Case

* Call for details.

PCR Plates

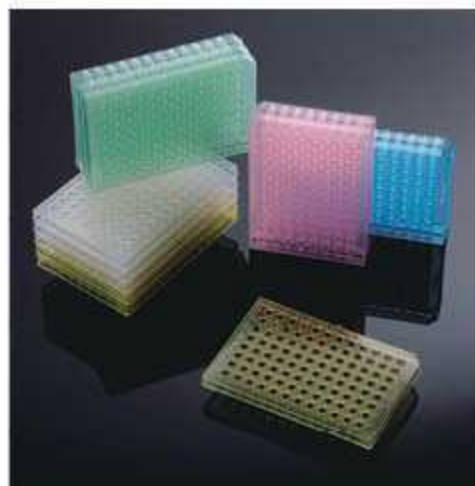

>> Features

- Made of high quality medical grade polypropylene
- Ultra-thin tube walls with uniform thickness for accelerated heat transfer, shorter cycle times, and more consistent results
- Alphanumeric well labeling for convenient identification
- DNase, RNase, and endotoxin free

Specifications

- Fits most standard thermocyclers
- Can withstand centrifugation of up to 6,000 RCF



Half-skirted plates are easy to insert and remove

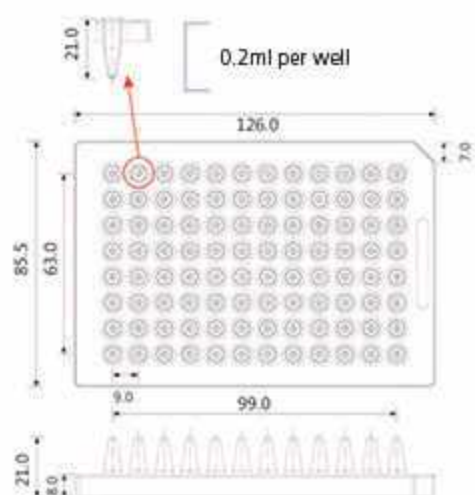

Dimensions = mm

Cat #	Well	Skirt	Color	Sterile	Unit	Total
60-0056	96-well	Half-Skirted	Clear	No	5 /Bag, 5 Bags /Pack, 4 Packs/Case	100 /Case
60-0156*	96-well	Half-Skirted	Pink	No	5 /Bag, 5 Bags /Pack, 4 Packs/Case	100 /Case
60-0256*	96-well	Half-Skirted	Green	No	5 /Bag, 5 Bags /Pack, 4 Packs/Case	100 /Case
60-0356*	96-well	Half-Skirted	Blue	No	5 /Bag, 5 Bags /Pack, 4 Packs/Case	100 /Case
60-0456*	96-well	Half-Skirted	Yellow	No	5 /Bag, 5 Bags /Pack, 4 Packs/Case	100 /Case

* Call for details.

Biologix Plates ▶

60-0056
(Half-Skirted)



Brand	Model	
Real Time PCR Thermal Cyclers		
Applied Biosystems	7000	✓
	7300	✓
	7500	✓
	7700	✓
	7900HT	✓
	StepOne	
BioRad	iCycler	✓
	MyiQ	
	IQ5	✓
Eppendorf	MasterCycler ep Realplex	
MJ Research	Opticon	
	Opticon 2	
	Chromo 4	
	MX-4000	
	MX-3000	
Techne	Quantica	
PCR Thermal Cyclers		
Applied Biosystems	Veriti	✓
	9600	✓
	9700	✓
	7800FAST	
	2720	✓
Biomtra	Uno	✓
	Uno II	✓
	T1 Thermal Cycler	✓
	Tgradient	✓
	Trobot	✓
BioRad	iCycler	✓
	MyCycler	✓
Corbett Research	PalmCycler 96	✓
	PalmCycler 384	
Eppendorf	Mastercycler	✓
	Mastercycler ep	✓
	Mastercycler M384	
Flexi	Gene	✓
	Genius	✓

Biologix Plates ▶

60-0056
(Half-Skirted)



Brand	Model	
Ericom	Single Block	✓
	Twin Block	✓
	Deltacycler I	✓
ThermoHybaid	PCR Sprint	✓
	PCR Express	✓
	Multiblock System	✓
	Touchdown	✓
	Omnigene	✓
	Omn-E	✓
	pxe	✓
	px2	✓
MJ Research	PTC-100	✓
	PTC-200	✓
	PTC-225 Tetrad	✓
	Dyad/Disciple	✓
MWG	Primus 96	✓
	Primus 384	
Stratagene	Robocycler	
TaKaRa	TP240	
	TP3000	✓
Techne	Touchgene Gradient (TC512)	✓
	Genius (TC412)	✓
	Touchgene X	✓
Sequencers		
Applied Biosystems	3100	✓
	3130	✓
	3700	✓
	3730/3730x	✓

This chart is intended only as a general guide. Compatibility may vary based on your particular configuration and features. For further help with product selection, please contact us.

FOR TECHNICAL INFORMATION, VISIT WWW.BIOLOGIXGROUP.COM

Microbiology Series

Microbiology is the study of microbial morphology, physiology, biochemistry, genetic variation, and more. It plays an important role in the study of genetic engineering, as well as disease control and prevention. Our Microbiology Series of products covers all your basic microbiology supply needs.



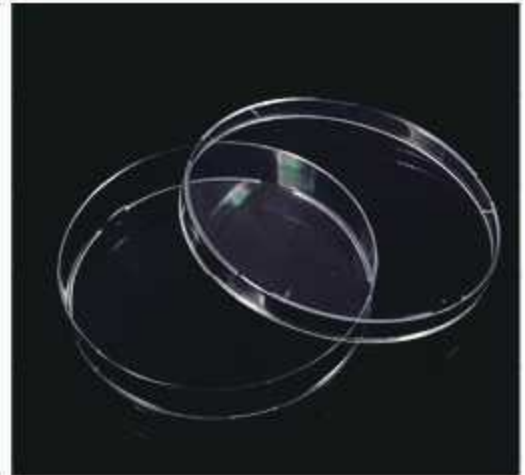

>> Features

- Made of medical grade polystyrene
- Highly transparent for microscopic analysis
- Three sizes available: 60mm, 90mm, or 150mm in diameter
- 66-1701 fit automatic systems
- Vented lid for better gas exchange
- Dishes are stackable
- EO Sterile

Vents for gas exchange



66-1560

66-1501



66-1701

Dimensions = mm

Cat.#	Size (mm)	Color	Sterile	Unit	Total
66-1560	60x15	Clear	Yes	10 /Bag, 50 Bags/Case	500 /Case
66-1501	90x15	Clear	Yes	10 /Bag, 50 Bags/Case	500 /Case
66-1701	90x17	Clear	Yes	10 /Bag, 50 Bags/Case	500 /Case
66-1515	150x15	Clear	Yes	10 /Bag, 20 Bags/Case	200 /Case

Inoculating Loops & Needles



>> Features

- Made of medical grade polystyrene
- Loops available in 1 μ L and 10 μ L sizes
- The opposite end of each loop can be used as a needle
- Needles are suitable for removal of single-colony specimens
- Gamma radiation sterilized, non-pyrogenic
- Packaged in resealable bags

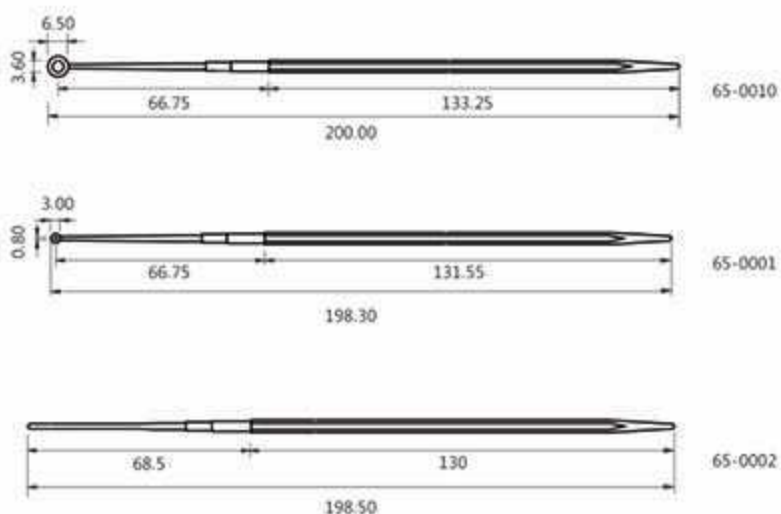

65-0010

Can be used as needles

65-0001

65-0002



Dimensions = mm

Cat. #	Size	Description	Color	Sterile	Unit	Total
65-0001	1 μ L	Loops	Blue	Yes	25 /Bag, 40 Bags/Case	1000 /Case
65-0010	10 μ L	Loops	Orange	Yes	25 /Bag, 40 Bags/Case	1000 /Case
65-0002	-	Needles	Yellow	Yes	25 /Bag, 40 Bags/Case	1000 /Case

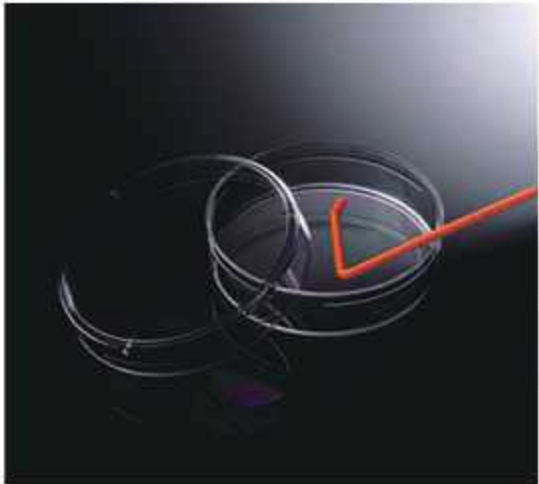
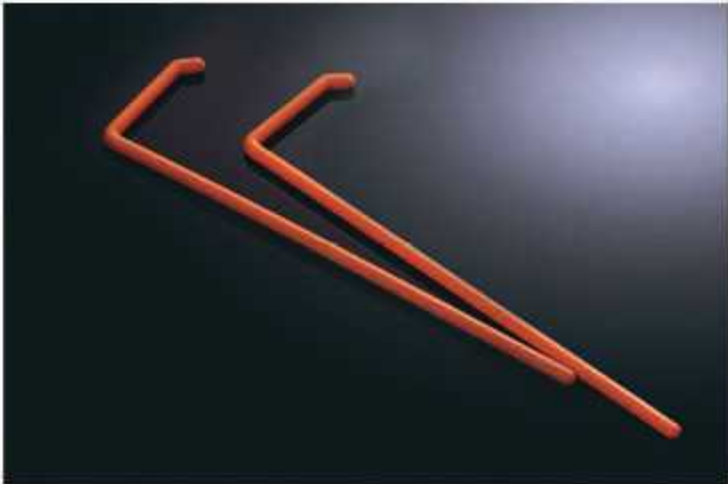

>> Features

- Polystyrene
- Smooth surface quality and angled end reduce the risk of damaging the culture medium
- L-shape allows application on the entire Culture Dish or plate surface
- Two package options: individually wrapped (sterile), or 10 per bag (sterile, resealable)
- Gamma radiation sterilized



Individually plastic packaging



Zip-seal packaging

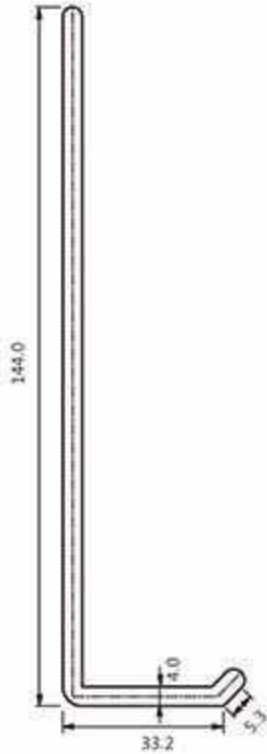

Dimensions = mm

Cat #	Color	Sterile	Unit	Total
65-1001	Orange	Yes	1 /Bag, 500 Bags/Case	500 /Case
65-1010	Orange	Yes	10 /Bag, 50 Bags/Case	500 /Case

A close-up photograph of a scientist in a laboratory setting. The scientist is wearing a white lab coat, a light blue hairnet, safety glasses, and a white surgical mask. They are holding a test tube with a blue liquid inside, and their hands are gloved in white. The background is a blurred laboratory environment with shelves and equipment.

Drosophila Culture

Drosophila Culture is the culture of *Drosophila melanogaster* fruit flies, which is a common practice in the fields of genetics and developmental biology, due to the convenience of raising *D. melanogaster*, its rapid breeding rate, and the ease with which its morphology can be identified. Our Drosophila Culture Series includes vials, bottles, and foam plugs in bulk or tray packaging.



>> Features

- Made of premium grade polystyrene
- Glass-like clarity for sample observation
- Disposable vials are a safe and cost-effective alternative to glass vials
- Narrow or wide vials available
- Both narrow and wide vials are available in bulk or tray packaging
- Tray packs are great for quick, effortless filling of vials



51-0500



51-0800

Dimensions = mm

Your can put your logo here



Cat #	Description	Dimensions (mm)	Sterile	Packaging	Unit	Total
51-0500	Narrow	25 x 95	No	Bulk	25 /Bag, 20 Bags/Case	500 /Case
51-0501	Narrow	25 x 95	No	Tray	100 /Tray, 5 Trays/Case	500 /Case
51-0800	Wide	28.5 x 95	No	Bulk	25 /Bag, 20 Bags/Case	500 /Case
51-0801	Wide	28.5 x 95	No	Tray	100 /Tray, 5 Trays/Case	500 /Case

Drosophila Bottles



>> Features

- Made of clear polypropylene
- Autoclavable
- Transparent bottle with square bottom
- Firm, stiff neck for easier handling

Molded graduations

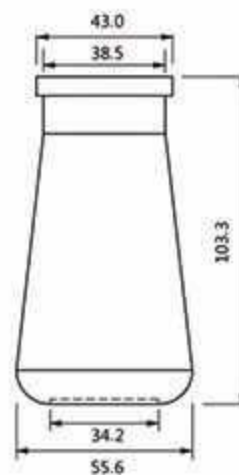

Dimensions = mm

Cat #	Sterile	Packaging	Unit	Total
51-17720	No	Bulk	200 /Bag, 1 Bag/Case	200 /Case
51-17721	No	Tray	25 /Tray, 8 Trays/Case	200 /Case

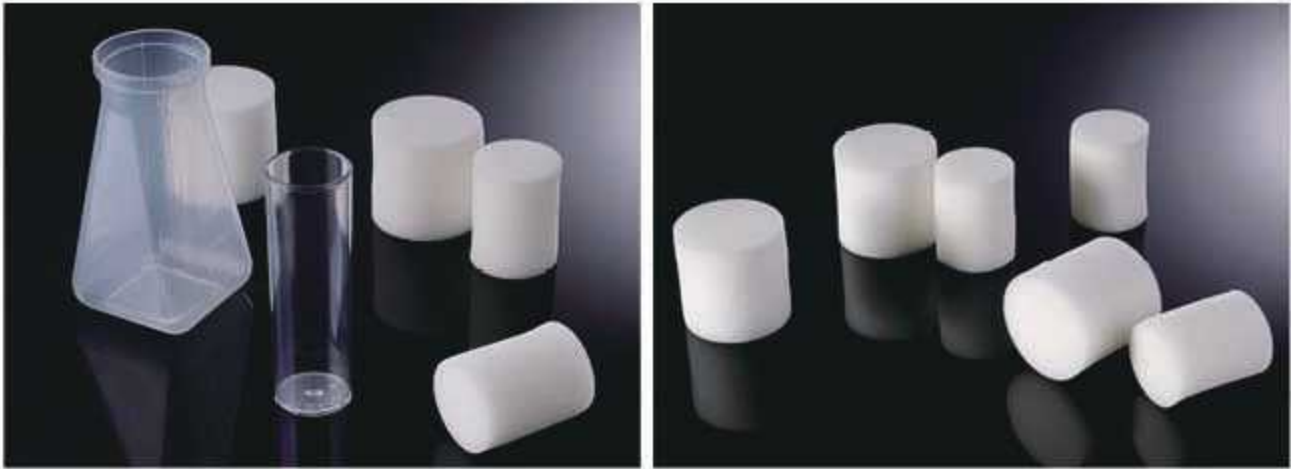

>> Features

- Made of high density foam
- Causes minimal shedding and reduces evaporation
- Maintains tight fit after repeated use and removal
- Fits Biologix Drosophila vials and bottles

Flat surface accepts can be marked



51-0505



51-0805



51-17725

Cat #	Applied #	Fits	Sterile	Unit	Total
51-0505	51-0500/0501	Narrow Drosophila Vials	No	100 /Bag, 10 Bags/Case	1000 /Case
51-0805	51-0800/0801	Wide Drosophila Vials	No	100 /Bag, 10 Bags/Case	1000 /Case
51-17725	51-17720/17721	Drosophila Bottles	No	50 /Bag, 20 Bags/Case	1000 /Case



Instruments

In addition to consumable lab supplies, laboratory instruments are also important tools for life science research. High-quality lab instruments can greatly improve research efficiency and ensure precise and accurate results. Biologix now supplies small laboratory instruments for a wide variety of applications, including liquid handling, mixing, PCR, centrifuging, electrophoresis, and more.



dPette Digital Pipette

Features

- Comprehensive range of liquid handling protocols
- Three aspiration/dispensing speeds
- Motor-drive with built-in error control
- Efficient lithium-ion rechargeable battery
- Autoclavable lower barrel



01-2306



Micro PettePlus Pipettes

Features

- Convenient one-handed operation
- Fully autoclavable
- Compatible with most standard pipette tips

Pipette Stand (01-2306)

- Holds up to six single- or multi-channel pipettes

Cat #	Type	Channels	Volume Range (μL)	Tip Volume
01-241X	dPette Digital Pipette	1	0.5-10 μL	0.01 μL
01-242X	dPette Digital Pipette	1	5-50 μL	0.1 μL
01-243X	dPette Digital Pipette	1	30-300 μL	1 μL
01-244X	dPette Digital Pipette	1	100-1000 μL	5 μL
01-2101	MicroPette Plus Pipettes	1	0.5-10 μL	0.1 μL
01-2104	MicroPette Plus Pipettes	1	10-100 μL	1 μL
01-2102	MicroPette Plus Pipettes	1	20-200 μL	1 μL
01-2110	MicroPette Plus Pipettes	1	100-1000 μL	5 μL
01-2115	MicroPette Plus Pipettes	1	1000-5000 μL	50 μL
01-2122	MicroPette Plus Pipettes	1	2-20 μL	0.5 μL
01-2155	MicroPette Plus Pipettes	1	5-50 μL	0.5 μL
01-2801	MicroPette Plus Pipettes	8	0.5-10 μL	0.1 μL
01-2805	MicroPette Plus Pipettes	8	5-50 μL	0.5 μL
01-2830	MicroPette Plus Pipettes	8	50-300 μL	5 μL

Liquid Handling



Levo ME Pipette Filler

Features

- Ergonomic shape and intuitive operation
- Pressure-sensitive buttons: increasing pressure increases aspiration/dispensing speed
- Autoclavable hydrophobic filter prevents over-aspiration
- LED light indicates aspiration/dispensing, charging, and low battery

Cat #	Type	Aspiration Speeds	Dispensing Speeds	Battery Life	Compatible Pipette Types
01-221X	Levo ME	aspirates 25mL of water in < 7 seconds	gravity dispensing	8+ hours of intermittent use	glass or plastic pipettes (0.1-100mL), Pasteur pipettes



Levo Plus Pipette Filler

Features

- Eight aspiration and dispensing speeds
- LCD display shows speed settings and remaining battery life
- Efficient lithium-ion battery can last for up to 8 hours of intermittent use
- Integral, autoclavable silicone adapter suits use with 0.1-100 mL pipettes

Cat #	Type	Aspirate Speeds	Dispense Speeds	Battery Life	Compatible Pipette Types
01-220X	Levo Plus	25ml < 5s (8 shift)	Motor (8 shift) / Gravity	8+ hours of intermittent use	glass or plastic pipettes (0.1-100mL), Pasteur pipettes



SAFEVAC Vacuum Aspiration System

Features

- Integrated pump with adjustable vacuum control
- Self-closing connectors for quick installation and dismantling, prevention of drips, and containment of aerosols
- Liquid level sensor prevents overflow
- Single-channel and multi-channel nozzles and other accessory options available

Cat #	Vacuum range	Pump flow rate	Dimensions [W x D x H]	Weight	Input voltage	Bottle volume
01-270X	0 - 600 mbar	1-15 ml/s	180 x240 x 450mm	3 kg	100-240 VAC, 50/60 Hz	4L



Laboratory Fluid Collection System

Features

- Filmed inner wall
- Connection type: Can be connected with fluid instruments of various brands
- Funnel type: Equipped with the valve funnel
- High sealing performance
- Equipped with super efficient filter with connector
- Optional: Liquid level alarm



Cat #	Product	Description	Unit
05-2720	Connection type	One 20L security bucket with inner film , One inner cover, One outer cover, One set of liquid-phase connector, One set of efficient filter connector, One inorganic or organic filter	1 Set/Case
05-2721	Funnel type	One 20L security bucket with inner film , One inner cover, One outer cover, One funnel with a cover, One set of efficient filter connector, One inorganic or organic filter	1 Set/Case
05-2791	Super efficient filter	Inorganic chemical filter	1 Set/Case
05-2792	Super efficient filter	Organic chemical filter	1 Set/Case
05-2793	Liquid lever alarm	Tactile liquid lever alarm	1 Set/Case
05-2797	Liquid carrying cart(standard)	Adjustable size; one cart and one tray	1 Set/Case
05-2798	Liquid carrying cart(intelligent)	Adjustable size; one cart and one tray; equipped with intelligent module	1 Set/Case

Stirrers



Classic Magnetic Stirrer

Features

- Powerful rare-earth permanent magnet
- PET stirring plate provides excellent chemical resistance
- Stand included



FlatSpin Magnetic Stirrer

Features

- Ultra-flat, space-saving design
- Automatic rotation-reversing stirring for better mixing results
- Slip-resistant and stable



Magnetic Stirrer Hotplate

Features

- Digital control system
- ABS casing is fire-retardant and resistant to weak acids and bases
- Ceramic-coated stainless steel hotplate is chemically resistant and scratch-proof
- Safety feature: HOT caution indicator is displayed at 50°C and above

Cat #	Type	Stirring plate size [mm]	Motor input rating [W]	Motor output rating [W]	Max. stirring quantity [L, H ₂ O]	Speed range [rpm]	Overheating Protection [°C]
01-330X	Classic	Ø 120	7.2	1.2	1.5	300-2000	-
01-320X	FlatSpin	Ø 90	5	3	0.8	15-1500	-
01-310X	Hotplate	Ø 135	5	3	3	100-1500	320



Vortex Mixer

Features

- Orbital mixing movement
- Touch and continuous operation settings
- Cast aluminum base and specially designed vacuum suction feet keep the mixer stable
- Various adapters and accessories available for use with tubes of different sizes ($\Phi 6\text{mm}$, $\Phi 10\text{mm}$, $\Phi 12\text{mm}$, $\Phi 16\text{mm}$, $\Phi 20\text{mm}$ test tubes and vessels $< 99\text{mm}$ in diameter)



Classic Rotators (axial)



Classic Rotators (radial)

Classic Rotators

Features

- End-over-end rotation
- Compact, space saving design
- Various adapters available for use with 1.5mL-50mL tubes

Cat #	Type	Speed range [rpm]	Operation mode	Voltage [V]	Power [W]
01-110X	Vortex Mixer	0-2500	Touch operation/Continuous	110-120/220-230	60
01-120X	Classic Rotator	0-80	Continuous	100-240	20
01-130X	Classic Rotator	0-80	Continuous	100-240	20

Shakers



Linear and Orbital Shakers

Features

- Continuous operation
- Sturdy aluminum-alloy platform
- Tray platform, non-slip mat, and elastic bands included
- Various platforms available

Cat #	Type	Power [W]	Operation type	Max. load capacity (with platform) [kg]	Shaking speed range [rpm]
01-610X	Linear Shaker	30	Continuous	3	40-200
01-620X	Orbital Shaker	30	Continuous	3	40-200



LED Digital Linear and Orbital Shakers

Features

- Timed and continuous operation
- LED displays for timer and shaking speed

Cat #	Type	Power [W]	Operation type	Max. load capacity (with platform) [kg]	Shaking speed range [rpm]
01-611X	LED Digital Linear Shaker	30	Continuous	3	40-200
01-621X	LED Digital Orbital Shaker	30	Continuous	3	40-200



Rocking and 3D Shakers

Features

- Continuous operation
- Sturdy aluminum-alloy platform
- Tray platform, non-slip mat, and elastic bands included
- Various platforms available for use with different types of vessels

Cat #	Type	Power [W]	Shaking motion	Tilt angle	Max. load capacity (with platform) [kg]	Shaking speed range [rpm]
01-630X	Rocking Shaker	20	See-saw rocking	7°	3	10-80
01-640X	3D Shaker	20	3D orbital	7°	3	10-80



LED Digital Rocking and 3D Shakers

Features

- Timed and continuous operation
- LED displays for timer and shaking speed

Cat #	Type	Power [W]	Shaking motion	Tilt angle	Max. load capacity (with platform) [kg]	Shaking speed range [rpm]
01-631X	LED Digital Rocking Shaker	20	See-saw rocking	7°	3	10-80
01-641X	LED Digital 3D Shaker	20	3D orbital	7°	3	10-80

Thermocyclers



Gradient Thermocycler

Features

- Thermal gradient: program different temperatures across different areas of the heating block
- Consistent and uniform sealing across entire heating block
- Intuitive touch-screen user interface



Thermocycler

Features

- Consistent and uniform sealing across entire heating block
- Intuitive touch-screen user interface

Cat #	Type	Heating Temperature Range [°C]	Temperature Display Accuracy [°C]	Max. Heating/Cooling Rate [°C/s]	Gradient Temperature Setting Range [°C]	Gradient Range [°C]
01-700X	Gradient Thermocycler	4-99	0.1	3	30-99	1-42
01-710X	Thermocycler	4-99	0.1	3	-	-



Palm Micro Centrifuge

Features

- Quick acceleration and deceleration
- Rotors for microcentrifuge tubes, PCR tubes, and PCR 8-strip tubes included.
- Quiet, low-noise design

Cat.#	Type	Speed Range [rpm]	Max. RCF [×g]	Rotor Capacity
01-800X	Palm Micro Centrifuge	7000	2680	0.2ml/0.5ml/1.5ml/2ml x 8; 0.2ml PCR tubes x 16 or 0.2ml PCR 8-strips x 2



Mini and Mini-Plus High Speed Centrifuges

Features

- Brushless DC motor quickly accelerates rotor to the set speed
- Rotors are designed for 1.5ml and 2ml microcentrifuge tubes; adapters for 0.2ml and 0.5ml tubes are also available

Specifications

- 01-821X (Mini-Plus) with 01-829† plastic rotor kit*
- Low noise: 54dB; delivers fast acceleration and deceleration

Cat.#	Type	Speed Range [rpm]	Max. RCF [×g]	Rotor Capacity	Speed Accuracy [rpm]	Temperature Range [°C]
01-821X	Mini High Speed Centrifuge	500-15000; increment: 100	15100; increment: 100	0.2ml/0.5ml/ 1.5ml/2.0ml x 12	±20	N/A

Centrifuges



High Speed Micro-Centrifuge

Features

- Bio-safe rotor prevents sample overflow and ensures samples do not leak during the centrifuging process
- High strength aluminum alloy rotor is autoclavable and highly durable
- Four different rotors are available, assembled with 1.5ml/2ml x 24



High Speed Refrigerated Micro-Centrifuge

Features

- Powerful cooling system quickly cools chamber to 2°C after only 7 minutes, and keeps sample temperature below 2°C while centrifuging at maximum speed
- FastTemp: pre-cooling feature begins cool down prior to operation and ensures maximal temperature accuracy inside the chamber
- Four different rotors are available, assembled with 1.5ml/2ml x 24

Cat #	Type	Speed Range (rpm)	Max. RCF [xg]	Rotor Capacity	Speed Accuracy (rpm)	Temperature Range [°C]
01-830X	High Speed Micro-Centrifuge	200-15000; increment: 10	21380; increment: 10	5ml x 18; 0.2ml/0.5ml/ 1.5ml/2ml x 24; 0.5ml x 36; PCR8 x 4	±20	N/A
01-831X	High Speed Refrigerated Micro-Centrifuge					-20-40



Dry Bath Incubator

Features

- A broad temperature range, from room temperature to 120°C
- Continuous and timed operation settings
- Over-temperature protection
- Various interchangeable heating blocks are available (0.2ml x 54, 0.5ml x 40, 1.5/2ml x 40, 5/15ml x 28, 50ml x 8, 0.2ml+0.5ml+1.5/2ml, 96 or 384 well plate)

Cat #	Type	Functions	Temperature uniformity [°C]	Overheating protection	Max heating rate [°C/min]
01-910X	Dry Bath Incubator	Heating	Max ± 0.5	140 °C	5.5



Hot/Cold Dry Bath Incubator

Features

- Excellent temperature control system
- Can maintain hot or cold temperatures
- Supports creating and saving custom operation programs
- Various interchangeable heating blocks are available (24 x 0.5ml, 24 x 1.5ml, 24 x 2ml, 8 x 5ml, 8 x 15ml, 4 x 50ml, well plate, 0.2 x 96 PCR plate)

Cat #	Type	Functions	Temperature range	Temperature control accuracy [°C, at 20–45°C]	Max heating rate [°C/min]
01-920X	Hot/Cold Dry Bath	Heating & cooling	Heating: room temp. ~110°C Cooling: room temp. ~ below room temp. 25°C	± 0.5	5.5

Dry Bath Incubators



Shaker Incubator

Features

- Excellent temperature control system
- Can maintain hot or cold temperatures
- Orbital shaking movement function
- Supports creating and saving custom programs
- Various interchangeable heating blocks are available (24 x 0.5ml, 24 x 1.5ml, 24 x 2ml, 8 x 5ml, 8 x 15ml, 4 x 50ml, well plate, 0.2 x 96 PCR plate)

Cat #	Type	Functions	Temperature range	Max heating rate [°C/min]	Max cooling rate [°C/min]	Shaking speed range [rpm]
01-930X	Shaker Incubator	Heating, cooling, & mixing	Heating: room temp. - 100°C Cooling: room temp. - below room temp. 25°C	5.5	5 (110°C - room temp.) 0.5 (below room temp.)	300-1500



One Block Unit



Dual Block Unit

Elite Series Dry Bath Incubators

Features

- PID temperature control maintains temperature accuracy
- Leak-proof molded aluminum alloy chamber with PTFE coating
- Multi-functional: can also be used as a water bath or bead bath
- Various interchangeable heating blocks are available (0.2ml tubes x 64 or PCR 8-strip tubes x 8, 0.5ml tubes x 20, 1.5ml or 2.0ml tubes x 20, 15ml x centrifuge tubes x12, 50ml x centrifuge tubes x4)
- Blocks are not included, need to buy separately.

Cat #	Type	Display	Temperature Control Range [°C]	Temperature Increment [°C]	Temperature Accuracy at 37 [°C]	Operation Modes
03-4221	Elite Series One-Block Dry Bath Incubator	LCD Display	5 above ambient to 150	0.10	±20	Continuous or timed up to 99 hr:59 min
03-4222	Elite Series Dual Block Dry Bath Incubator					



Mini 300V Power Supply



300V Power Supply

Power Supplies

Features

- Stackable and programmable
- Multiple safety features: no-load detection, shrouded plugs and sockets, leakage detection, over-temperature protection, crossover protection, full floating, over-current/over-voltage detection

Cat #	Type	Output Voltage / Inc [V]	Output Current / Inc [mA]	Max Power [W]
03-1300	Mini 300V Power Supply	10-300/1	10-400/1	60
03-2310	300V Power Supply	5-300/1	1-700/1	150



03-3100

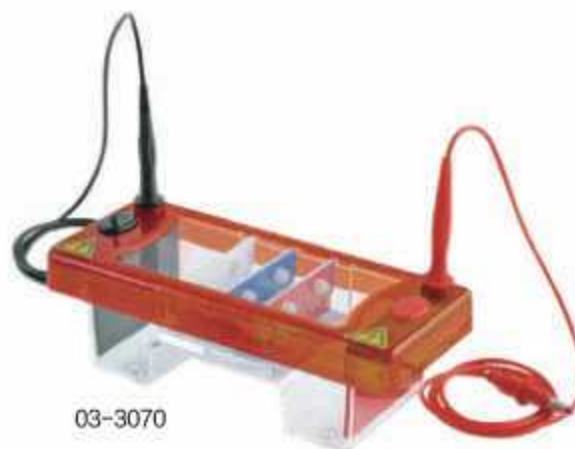

03-3070

Electrophoresis Tanks

Features

- Injection molded, leak-proof tank
- No tapes, clamps, or springs required
- Low buffer consumption
- Multiple tray sizes and combs available

Cat #	Tank Dimensions [W x L x H]	Gel Dimensions [mm]	Max. Sample Capacity [mm]	Rapid Casting Gel
03-3070	210 x 90 x 90mm	70 x 70, 70 x 100	32 for 70 x 70 64 for 70 x 100	Offer gel maker
03-3100	220 x 125 x 90mm	100 x 70, 100 x 100	50 for 100 x 70 100 for 100 x 100	Offer gel maker

BluView Transilluminator

Super bright blue LED lights can be used with a variety of safe dyes, and the lights are harmless and safe to view the experiment result. You can cut the gel with accuracy. With its compact size and light weight, the transilluminator occupies little of your lab bench and is easy to move from lab to lab.



BluView Transilluminator

Features

- Compact, and easy to carry
- Aluminum alloy casing design
- Low heat dispersion
- Energy saving product
- 470nm harmless blue light for direct human contact
- Thinner and more lightweight body
- Use accessories to document experiment results by a smart phone

Cat #	Blue Light Wavelength [nm]	Base Design	Construction Material	Power Adaptor	Filter Viewing Surface Dimensions [mm]
03-6210	470	Flat bed	Aluminum alloy	12VDC/5A, 60W Max.	153×153

Application Guidelines

Maximum centrifugal acceleration force can be influenced by following criteria:

- Use of organic solutions, temperature below 0°C, centrifuging without centrifuge adapter, etc. Conduct a trial run to determine proper conditions before any critical use begins.
- The RCF (relative centrifugal force) or G ratings for our disposable centrifuge tubes have been established at room temperature using tubes filled to nominal capacity with water and centrifuging for 30 minutes. recommended carriers, adapters, and cushions that fully support the tubes. If an angle head rotor is used or proper support is not provided, G values will be lower.
- Do not confuse speed or revolutions per minute (RPM) with relative centrifugal force (RCF). Instructions for centrifuging a sample at a given RPM and time are incomplete unless the rotor or radius is specified. Protocols should always state the time and RCF value for centrifuging a sample.

Autoclaving guideline for Plastics

To ensure successful steam sterilization of your plastic labware please adhere to the following guidelines:

PLEASE NOTE THAT NOT ALL PRODUCTS ARE AUTOCLAVABLE. Autoclave plastic consumables at 121°C and 15psi/1 atm for 15 minutes. Do not use a dry cycle, as this may cause deformation or weakening of the plastic. Allow temperature within the autoclave to return to 80°C or below before removing products.

Our Commitment to Quality

At Biologix, we look at quality from every angle in terms of functionality, safety, purity, formulation, consistency, manufacturing, customer service, technical support, and much more, all in order to consistently ensure customer satisfaction.

According to the detailed QA/QC procedures for our manufacturing facility, each and every product is traceable by lot, regardless of packaging format. Products must go through a five-step human inspection before being released for packaging.

Our facility is equipped with the latest instruments and technology from the most trusted manufacturers, ensuring that Biologix applies the most stringent standards to certify that products are free from RNase, DNase, endotoxin (pyrogens), etc.

In addition to being ISO 9001:2008, CE, and FDA compliant, we also make available to our customers lot-specific certificates such as Sterilization Certificates, Nuclease Free Certificates, Certificates of Origin, etc. Certificates of Compliance can also be downloaded directly from our website: www.BiologixGroup.com.

Note: Product parameters within this catalogue are for reference only.

Chemical Resistance Form

For Biologix Plastic Laboratory Supplies

	PS	PP	HDPE	LDPE	PVC	CA	PC	CN	NY	MCE	PTFE	PET
Acids												
Hydrochloric acid (25%)	G	G	G	G	G	N	R	R	N	O	R	R
Hydrochloric acid (concentrated)	F	G	G	G	F	N	R	N	N	N	R	O
Nitric acid (concentrated)	P	P	N	N	P	N	R	N	N	N	O	N
Nitric acid (25%)	P	G	F	F	F	N	R	L	N	O	R	R
Alcohols												
Butanol	G	G	G	G	G	R	R	R	R	R	R	R
Ethanol	G	G	G	G	G	R	R	N	R	O	R	R
Methanol	G	G	G	G	G	R	R	N	R	O	R	R
Amines												
Aniline	G	G	G	G	P	N	N	R	R	N	R	O
Dimethylformamide	P	G	G	G	F	N	N	N	R	N	R	N
Bases												
Ammonium hydroxide (25%)	F	G	G	G	G	R	N	R	R	O	N	O
Ammonium hydroxide (1N)	F	G	G	G	G	N	N	R	R	O	N	N
Sodium hydroxide	G	G	G	G	G	N	N	N	R	N	R	N
Hydrocarbons												
Hexane	P	G	G	G	F	R	R	R	R	R	R	R
Toluene	P	G	N	N	P	R	O	R	R	R	R	N
Xylene	P	F	P	N	P	R	R	R	R	R	R	N
Dioxane	P	G	G	F	P	N	N	N	R	N	R	R
Dimethylsulfoxide (DMSO)	P	G	G	G	P	N	N	N	R	N	R	O*
Halogenated Hydrocarbons												
Chloroform	P	G	P	N	P	N	N	R	R	N	R	R
Methylene chloride	P	F	P	N	P	N	N	R	R	N	R	N
Ketones												
Acetone	P	G	G	G	P	N	O	N	R	N	R	R
Methyl ethyl diketone	P	G	G	G	P	N	O	N	R	O	R	R

* Can be used with aqueous solutions containing up to 20% DMSO.

The above chemical resistance chart is meant to be used as a guide only.

LEGEND

R = Recommended

L = Limited Resistance

N = Not Recommended

O = Testing Advised

F = Fair

G = Good

P = Poor

PS = Polystyrene

PP = Polypropylene

PVC = Polyvinyl Chloride

CA = Cellulose Acetate

PC = Polycarbonate

PTFE = Polytetrafluorethylene (Teflon)

CN = Cellulose Nitrate

NY = Nylon

MCE = Mixed Cellulose Esters

PET = Polyethylene Terephthalate



Biologix Group Limited

Phone: +86-531-67802668

Biologix Corporation

No.2766 Ying Xiu Road
High-Tech Industrial Development Zone
Jinan, Shandong 250101
P.R. China

Inquiry@BiologixGroup.com

www.BiologixGroup.com

www.CryoKING.com

Biologix USA, Inc.

10555 86th Ave. Pleasant Prairie, WI 53158 , USA

Phone: +1-888-3233585. 816

+1-816-6597165

Biologix Europe GmbH

Mathias-Brüggen-Str 156,
50829 Köln, Germany

