

Operating Manual

Translation of the original operating manual

KBF (E6)

Constant climate chambers with program control

Model	Model version	Art. No.
KBF 115	KBF115-230V	9020-0320, 9120-0320
	KBF115-240V	9020-0321, 9120-0321
KBF 240	KBF240-230V	9020-0322, 9120-0322
	KBF240-240V	9020-0323, 9120-0323
KBF 720	KBF720-230V	9020-0324, 9120-0324
	KBF720-240V	9020-0325, 9120-0325
KBF 1020	KBF1020-230V	9020-0326, 9120-0326
	KBF1020-240V	9020-0327, 9120-0327

KMF (E6)

Constant climate chambers
with enlarged temperature and humidity range
with program control

Model	Model version	Art. No.
KMF 115	KMF115-230V	9020-0341, 9120-0341
	KMF115-240V	9020-0342, 9120-0342
KMF 240	KMF240-230V	9020-0343, 9120-0343
	KMF240-240V	9020-0344, 9120-0344
KMF 720	KMF720-230V	9020-0345, 9120-0345
	KMF720-240V	9020-0346, 9120-0346

BINDER GmbH

Address
Tel.
Fax
Internet
E-mail
Service Hotline
Service Fax
Service E-Mail
Service Hotline USA
Service Hotline Asia Pacific
Service Hotline Russia and CIS

Post office box 102, 78502 Tuttlingen, Germany
+49 7462 2005 0
+49 7462 2005 100
<http://www.binder-world.com>
info@binder-world.com
+49 7462 2005 555
+49 7462 2005 93 555
service@binder-world.com
+1 866 885 9794 or +1 631 224 4340 x3
+852 390 705 04 or +852 390 705 03
+7 495 988 15 16

Content

1. SAFETY	6
1.1 Legal considerations	6
1.2 Structure of the safety instructions	6
1.2.1 Signal word panel	6
1.2.2 Safety alert symbol	7
1.2.3 Pictograms.....	7
1.2.4 Word message panel structure	8
1.3 Localization / position of safety labels on the chamber	8
1.4 Type plate.....	10
1.5 General safety instructions on installing and operating the chambers.....	11
1.6 Intended use.....	13
1.7 Operating instructions	13
1.8 Measures to prevent accidents	14
1.9 Resistance of the humidity sensor against harmful substances	15
2. CHAMBER DESCRIPTION	16
2.1 Chamber overview	17
2.2 Instrument panel.....	17
2.3 Lateral control panels	18
2.4 Rear view with water connections	19
3. COMPLETENESS OF DELIVERY, TRANSPORTATION, STORAGE, AND INSTALLATION	20
3.1 Unpacking, and checking equipment and completeness of delivery.....	20
3.2 Guidelines for safe lifting and transportation	21
3.3 Storage.....	21
3.4 Location of installation and ambient conditions.....	22
4. INSTALLATION AND CONNECTIONS	24
4.1 Spacer for wall distance	24
4.2 Wastewater connection.....	24
4.3 Freshwater supply	25
4.3.1 Automatic fresh water supply via water pipe	25
4.3.2 Manual fresh water supply via external freshwater can (option).....	26
4.3.3 Connection kit for connecting the chamber to the water main	26
4.3.4 Safety kit: Hose burst protection device with reflux protection device (available via BINDER INDIVIDUAL customized solutions)	27
4.4 Electrical connection	29
4.5 Connection of the voltage changer (option for KBF)	30
5. FUNCTIONAL OVERVIEW OF THE MB2 CHAMBER CONTROLLER	32
5.1 Operating functions in normal display	33
5.2 Display views: Normal display, program display, chart-recorder display.....	34
5.3 Controller icons overview	35
5.4 Operating modes.....	37
5.5 Controller menu structure.....	38
5.5.1 Main menu.....	39
5.5.2 "Settings" submenu	40
5.5.3 "Service" submenu	40
5.6 Principle of controller entries	41
5.7 Performance during and after power failures	41
5.8 Performance when opening the door	42

6.	START UP	42
6.1	Turning on the chamber	42
6.2	Controller settings upon start up	42
6.3	Turning on/off humidity control	43
7.	SET-POINT ENTRY IN “FIXED VALUE” OPERATING MODE	44
7.1	Set-point entry for temperature, humidity, and fan speed through the “Setpoints” menu	45
7.2	Direct setpoint entry via Normal display	46
7.3	Special controller functions via operation lines	46
8.	TIMER PROGRAM: STOPWATCH FUNCTION.....	47
8.1	Starting a timer program	47
8.1.1	Performance during program delay time	48
8.2	Stopping a running timer program.....	48
8.2.1	Pausing a running timer program	48
8.2.2	Cancelling a running timer program	49
8.3	Performance after the end of the program.....	49
9.	TIME PROGRAMS	50
9.1	Starting an existing time program	50
9.1.1	Performance during program delay time	51
9.2	Stopping a running time program	52
9.2.1	Pausing a running time program	52
9.2.2	Cancelling a running time program.....	52
9.3	Performance after the end of the program.....	52
9.4	Creating a new time program	53
9.5	Program editor: program management.....	53
9.6	Section editor: Section management	55
9.6.1	Add a new section	56
9.6.2	Copy and insert or replace a section	56
9.6.3	Deleting a section	57
9.7	Value entry for a program section	58
9.7.1	Section duration.....	58
9.7.2	Set-point ramp and set-point step	59
9.7.3	Special controller functions via operation lines.....	60
9.7.4	Temperature setpoint	61
9.7.5	Humidity setpoint	62
9.7.6	Tolerance range	62
9.7.7	Fan speed.....	64
9.7.8	Repeating one or several sections within a time program	64
9.7.9	Saving the time program	65
10.	WEEK PROGRAMS	66
10.1	Starting an existing week program	66
10.2	Cancelling a running week program.....	67
10.3	Creating a new week program	68
10.4	Program editor: program management.....	69
10.5	Section editor: Section management	70
10.5.1	Add a new section	71
10.5.2	Copy and insert or replace a section	72
10.6	Value entry for a program section	72
10.6.1	Set-point ramp and set-point step modes.....	72
10.6.2	Weekday.....	73
10.6.3	Start time	73
10.6.4	Temperature setpoint	74
10.6.5	Humidity setpoint	74
10.6.6	Fan speed.....	75
10.6.7	Special controller functions via operation lines.....	75
10.7	Deleting a week program	76

11. NOTIFICATION AND ALARM FUNCTIONS	77
11.1 Notification and alarm messages overview.....	77
11.1.1 Notifications	77
11.1.2 Alarm messages.....	78
11.1.3 Messages concerning the humidity system.....	78
11.2 State of alarm.....	79
11.3 Resetting an alarm, list of active alarms	79
11.4 Tolerance range settings.....	80
11.5 Activating / deactivating the audible alarm (alarm buzzer).....	81
12. TEMPERATURE SAFETY DEVICES	82
12.1 Over temperature protective device (class 1)	82
12.2 Overtemperature safety controller class 3.1	82
12.2.1 Safety controller modes	82
12.2.2 Setting the safety controller	83
12.2.3 Message and measures in the state of alarm	84
12.2.4 Function check	84
12.3 Temperature safety device class 3.3 (option)	85
12.3.1 Temperature safety device class 3.1.....	86
12.3.2 Temperature safety device class 3.2.....	87
13. USER MANAGEMENT	88
13.1 Authorization levels and password protection	88
13.2 Log in.....	91
13.3 Log out	92
13.4 User change.....	92
13.5 Password assignment and password change.....	93
13.5.1 Password change	93
13.5.2 Deleting the password for an individual authorization level	96
13.5.3 New password assignment for “service” or “admin” authorization level when the password function was deactivated.....	97
13.6 Activation code.....	98
14. GENERAL CONTROLLER SETTINGS.....	99
14.1 Selecting the controller’s menu language	99
14.2 Selecting the temperature unit	99
14.3 Setting date and time	100
14.4 Display configuration	102
14.4.1 Adapting the display parameters ().....	102
14.4.2 Touchscreen calibration	104
14.5 Network and communication.....	105
14.5.1 Serial interfaces.....	105
14.5.2 Ethernet	106
14.5.3 Web server	107
14.5.4 E-Mail.....	109
14.6 Data import / export via USB medium.....	111
15. GENERAL INFORMATION	112
15.1 Service contact page.....	112
15.2 Current operating parameters	112
15.3 Event list.....	113
15.4 Technical chamber information.....	114
16. CHART RECORDER DISPLAY.....	114
16.1 Views.....	115
16.2 Setting the parameters.....	117
17. HUMIDIFICATION / DEHUMIDIFICATION SYSTEM	119
17.1 Function of the humidifying and dehumidifying system.....	121



18. DEFROSTING AT REFRIGERATING OPERATION	122
19. OPTIONS.....	123
19.1 Communication software APT-COM™ 3 DataControlSystem (option).....	123
19.2 RS485 interface (option)	123
19.3 Data logger kits (option).....	123
19.4 Analog outputs for temperature and humidity (option).....	124
19.5 Zero-voltage relay alarm outputs for temperature and humidity (option)	124
19.6 Water protected internal socket (option for KBF – not for UL chambers).....	125
19.7 Additional flexible Pt 100 temperature sensor (available via BINDER INDIVIDUAL customized solutions).....	126
19.8 Object temperature display with flexible Pt 100 temperature sensor (option).....	126
19.9 External freshwater and wastewater cans (option)	127
19.9.1 Mounting the freshwater can	127
19.9.2 Mounting the wastewater can	129
19.9.3 Mounting with wastewater recycling	130
19.10 BINDER Pure Aqua Service (option).....	131
20. MAINTENANCE, CLEANING, AND SERVICE.....	131
20.1 Maintenance intervals, service	131
20.2 Cleaning and decontamination.....	132
20.2.1 Cleaning.....	132
20.2.2 Decontamination.....	134
20.3 Sending the chamber back to BINDER GmbH	135
21. DISPOSAL.....	135
21.1 Disposal of the transport packing.....	135
21.2 Decommissioning.....	136
21.3 Disposal of the chamber in the Federal Republic of Germany.....	136
21.4 Disposal of the chamber in the member states of the EC except for the Federal Republic of Germany.....	137
21.5 Disposal of the chamber in non-member states of the EC	138
22. TROUBLESHOOTING	139
23. TECHNICAL DESCRIPTION.....	141
23.1 Factory calibration and adjustment	141
23.2 Over current protection.....	141
23.3 Definition of usable volume	142
23.4 KBF Technical Data	142
23.5 KMF technical data.....	144
23.6 Equipment and options (extract)	146
23.7 Spare parts and accessories (extract)	147
23.8 Dimensions size 115	149
23.9 Dimensions size 240	150
23.10 Dimensions size 720	151
23.11 Dimensions size 1020	152
24. CERTIFICATES AND DECLARATIONS OF CONFORMITY	153
24.1 EU Declaration of Conformity for KBF	153
24.2 EU Declaration of Conformity for KMF	155
24.3 Certificate for the GS mark of conformity of the “Deutsche Gesetzliche Unfallversicherung e.V.“ (German Social Accident Insurance) DGUV	157
25. PRODUCT REGISTRATION	159
26. CONTAMINATION CLEARANCE CERTIFICATE.....	160
26.1 For chambers located outside USA and Canada.....	160
26.2 For chambers located in USA and Canada.....	163

Dear customer,

For the correct operation of the chambers, it is important that you read this operating manual completely and carefully and observe all instructions as indicated. Failure to read, understand and follow the instructions may result in personal injury. It can also lead to damage to the chamber and/or poor equipment performance.

1. Safety

This operating manual is part of the components of delivery. Always keep it handy for reference. The device should only be operated by laboratory personnel especially trained for this purpose and familiar with all precautionary measures required for working in a laboratory. Observe the national regulations on minimum age of laboratory personnel. To avoid injuries and damage observe the safety instructions of the operating manual.

	 WARNING
	<p>Failure to observe the safety instructions. Serious injuries and chamber damage.</p> <ul style="list-style-type: none">➤ Observe the safety instructions in this operating manual.➤ Carefully read the complete operating instructions of the chambers.

1.1 Legal considerations

This operating manual is for informational purposes only. It contains information for installing, start-up, operation and maintenance of the product. Note: the contents and the product described are subject to change without notice.

Understanding and observing the instructions in this operating manual are prerequisites for hazard-free use and safety during operation and maintenance. In no event shall BINDER be held liable for any damages, direct or incidental arising out of or related to the use of this manual.

This operating manual cannot cover all conceivable applications. If you would like additional information, or if special problems arise that are not sufficiently addressed in this manual, please ask your dealer or contact us directly by phone at the number located on page one of this manual

Furthermore, we emphasize that the contents of this operating manual are not part of an earlier or existing agreement, description, or legal relationship, nor do they modify such a relationship. All obligations on the part of BINDER derive from the respective purchase contract, which also contains the entire and exclusively valid statement of warranty administration. The statements in this manual neither augment nor restrict the contractual warranty provisions.

1.2 Structure of the safety instructions

In this operating manual, the following safety definitions and symbols indicate dangerous situations following the harmonization of ISO 3864-2 and ANSI Z535.6.

1.2.1 Signal word panel

Depending on the probability of serious consequences, potential dangers are identified with a signal word, the corresponding safety color, and if appropriate, the safety alert symbol.

 DANGER
Indicates an imminently hazardous situation that, if not avoided, will result in death or serious (irreversible) injury.

WARNING

Indicates a potentially hazardous situation which, if not avoided, could result in death or serious (irreversible) injury.

CAUTION

Indicates a potentially hazardous situation which, if not avoided, may result in moderate or minor (reversible) injury.

CAUTION

Indicates a potentially hazardous situation which, if not avoided, may result in damage to the product and/or its functions or of a property in its proximity.

1.2.2 Safety alert symbol







Use of the safety alert symbol indicates a **risk of injury**.

Observe all measures that are marked with the safety alert symbol in order to avoid death or injury.

1.2.3 Pictograms

Warning signs			
Electrical hazard	Hot surface	Explosive atmosphere	Stability hazard
Lifting hazard	Scalding hazard	High humidity	Danger of frost
Risk of corrosion and / or chemical burns	Harmful substances	Biohazard	Pollution Hazard
Mandatory action signs			
Mandatory regulation	Read operating instructions	Disconnect the power plug	Lift with several persons
Lift with mechanical assistance	Environment protection	Wear protective gloves	Wear safety goggles

Prohibition signs			
 Do NOT touch	 Do NOT spray with water	 Do NOT climb	

	Information to be observed in order to ensure optimum function of the product.
---	---

1.2.4 Word message panel structure

<p>Type / cause of hazard.</p> <p>Possible consequences.</p> <ul style="list-style-type: none"> ⊘ Instruction how to avoid the hazard: prohibition ➤ Instruction how to avoid the hazard: mandatory action.

Observe all other notes and information not necessarily emphasized in the same way, in order to avoid disruptions that could result in direct or indirect injury or property damage.

1.3 Localization / position of safety labels on the chamber

The following labels are located on the chamber:











Pictograms (warning signs)				
	Risk of injury (on outer door, only KBF-240V and KMF-240V). Observe the safety instructions in the operating manual.			
	Hot surface (inner glass door above the glass door handle)			
	<table border="1" style="display: inline-table; vertical-align: middle;"> <tr> <td style="text-align: center;">  </td> <td> WARNING Hot Surface. Escape of hot steam. Burning & Scalding Hazard. Access only when cold. </td> <td style="text-align: center;">  </td> </tr> </table>		WARNING Hot Surface. Escape of hot steam. Burning & Scalding Hazard. Access only when cold.	
	WARNING Hot Surface. Escape of hot steam. Burning & Scalding Hazard. Access only when cold.			
Burning and scalding hazard (chamber rear)				
Service label				
<p style="margin: 0;">Service - Hotline</p> <p style="margin: 0;">International: + 49 (0) 7462 / 2005-555</p> <p style="margin: 0;">USA Toll Free: + 1 866 885 9794</p> <p style="margin: 0;">or: + 1 631 224 4340</p> <p style="margin: 0;">Россия и СНГ: + 7 495 98815 17</p> <p style="margin: 0; font-size: small;">service@binder-world.com www.binder-world.com</p> <p style="text-align: right; margin: 0;"></p>				



Figure 1: Position of labels on the chamber front (KBF-240V and KMF-240V)

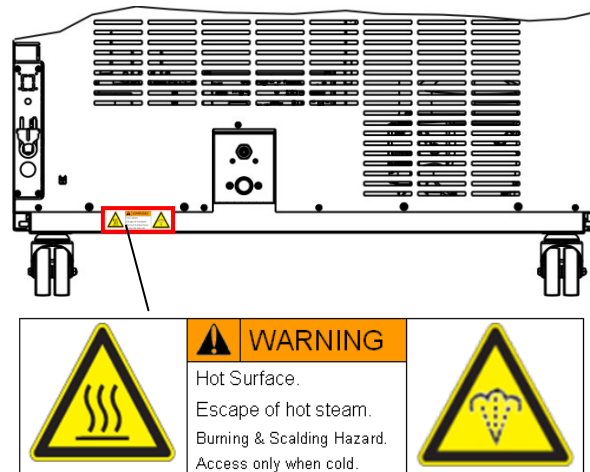

Figure 2: Position of labels on the chamber rear



Keep safety labels complete and legible.

Replace safety labels that are no longer legible. Contact BINDER Service for these replacements.

1.4 Type plate

The type plate sticks to the left side of the chamber, bottom right-hand.











Nominal temp.	70 °C	2,10 kW / 9,5 A				Max. operating pressure 15 bar R 134A – 0,17 kg Contains fluorinated greenhouse gases covered by the Kyoto Protocol
	158 °F	200-230 V / 50 Hz				
IP protection	20	200-230 V / 60 Hz				
Safety device	DIN 12880	1 N ~				
Class	3.1					
Art. No.	9020-0322					
Project No.						
Built	2016	Constant climate chamber				
		BINDER GmbH Im Mittleren Ösch 5 78532 Tuttlingen / Germany www.binder-world.com	KBF 240 E6			Serial No. 00-00000 Made in Germany

Figure 3: Type plate (example KBF 240 regular chamber 9020-0322)

Indications of the type plate (example)		Information
BINDER		Manufacturer: BINDER GmbH
KBF 240		Model designation
Constant climate chamber		Device name
Built	2016	Serial no. of the chamber
Serial No.	00-00000	Year of construction
Nominal temperature	70 °C / 158 °F	Nominal temperature
IP protection	20	IP type of protection acc. to standard EN 60529
Temp. safety device	DIN 12880	Temperature safety device acc. to standard DIN 12880:2007
Class	3.1	Class of temperature safety device
Art. No.	9020-0322	Art. no. of the chamber
Project No.	---	Optional: Special application acc. to project no.
2,10 kW		Nominal power
9,5 A		Nominal current
200-230 V / 50 Hz		Nominal voltage range +/-10% at the indicated power frequency
200-230 V / 60 Hz		
1 N ~		Current type
Max. operating pressure 15 bar		Max operating pressure in the refrigerating system (15 bar / 218 PSI)
R 134A - 0,17 kg		Refrigerant type and filling weight
Contains fluorinated greenhouse gases covered by the Kyoto Protocol		

Symbol on the type plate	Information
	CE conformity marking
	Electrical and electronic equipment manufactured / placed on the market in the EC after 13 August 2005 and be disposed of in separate collection according to Directive 2012/19/EU on waste electrical and electronic equipment (WEEE).
	GS mark of conformity of the "Deutsche Gesetzliche Unfallversicherung e.V. (DGUV), Prüf- und Zertifizierungsstelle Nahrungsmittel und Verpackung im DGUV Test" (German Social Accident Insurance (DGUV), Testing and Certification Body for Foodstuffs and Packaging Industry in DGUV Test).
	The chamber is certified according to Customs Union Technical Regulation (CU TR) for Russia, Belarus and Kazakhstan.

1.5 General safety instructions on installing and operating the chambers



With regard to operating the chambers and to the installation location, please observe the DGUV guidelines 213-850 on safe working in laboratories (formerly BGI/GUV-I 850-0, BGR/GUV-R 120 or ZH 1/119, issued by the employers' liability insurance association) (for Germany).

BINDER GmbH is only responsible for the safety features of the chamber provided skilled electricians or qualified personnel authorized by BINDER perform all maintenance and repair, and if components relating to chamber safety are replaced in the event of failure with original spare parts.



To operate the chamber, use only original BINDER accessories or accessories from third-party suppliers authorized by BINDER. The user is responsible for any risk caused by using unauthorized accessories.

	CAUTION
	<p>Danger of overheating. Damage to the chamber.</p> <ul style="list-style-type: none"> ⊘ Do NOT install the chamber in unventilated recesses. ➤ Ensure sufficient ventilation for dispersal of the heat.

Do not operate the chambers in hazardous locations.



	 DANGER
	<p>Explosion hazard. Danger of death.</p> <ul style="list-style-type: none"> ⊘ Do NOT operate the chamber in potentially explosive areas. ⊘ KEEP explosive dust or air-solvent mixtures AWAY from the chamber.

The chambers do not dispose of any measures of explosion protection.

	 DANGER
	<p>Explosion hazard. Danger of death.</p> <ul style="list-style-type: none"> ⊘ Do NOT introduce any substance into the constant climate chamber which is combustible or explosive at working temperature. ⊘ NO explosive dust or air-solvent mixture in the inner chamber.



Any solvent contained in the charging material must not be explosive or inflammable. I.e., irrespective of the solvent concentration in the steam room, NO explosive mixture with air must form. The temperature inside the chamber must lie below the flash point or below the sublimation point of the charging material. Familiarize yourself with the physical and chemical properties of the charging material, as well as the contained moisture constituent and its behavior with the addition of heat energy and humidity.



Familiarize yourself with any potential health risks caused by the charging material, the contained moisture constituent or by reaction products that may arise during the temperature process. Take adequate measures to exclude such risks prior to putting the chamber into operation.

	 DANGER
	<p>Electrical hazard. Danger of death.</p> <p>∅ The chamber must NOT become wet during operation or maintenance.</p>

The chambers were produced in accordance with VDE regulations and were routinely tested in accordance to VDE 0411-1 (IEC 61010-1).

During and shortly after operation, the temperature of the inner surfaces almost equals the set-point.

	 CAUTION
	<p>The glass doors, the glass door handles, and the inner chamber will become hot during operation.</p> <p>Danger of burning.</p> <p>∅ Do NOT touch the glass doors, the inner surfaces or the charging material during operation.</p>

 	 WARNING
	<p>Stability hazard. Danger of injury. Damage to the chamber and the charging material. Housing cover breakaway.</p> <p>∅ Do NOT climb on the lower housing cover.</p> <p>∅ Do NOT load the lower housing cover with heavy objects while the chamber door is open.</p>



1.6 Intended use

Constant climate chambers series KBF and KMF are suitable for exact conditioning of harmless materials. A mixture of any component of the charging material with air must NOT be explosive. The operating temperature must lie below the flash point or below the sublimation point of the charging material. Any component of the charging material must NOT be able to release toxic gases.

Other applications are not approved.

The chambers are not classified as medical devices as defined by the Medical Device Directive 93/42/EEC.

	Following the instructions in this operating manual and conducting regular maintenance work (chap. 20) are part of the intended use.
---	--

	 DANGER
	<p>Explosion or implosion hazard.</p> <p>Danger of poisoning.</p> <p>Danger of death.</p> <ul style="list-style-type: none"> ∅ Do NOT introduce any substance combustible or explosive at working temperature into the chamber, in particular no energy sources such as batteries or lithium-ion batteries. ∅ NO explosive dust or air-solvent mixture in the inner chamber. ∅ Do NOT introduce any substance which could lead to release of toxic gases.

	The charging material shall not contain any corrosive ingredients that may damage the machine components made of stainless steel, aluminum, and copper. Such ingredients include in particular acids and halides. Any corrosive damage caused by such ingredients is excluded from liability by BINDER GmbH.
---	--

	WARNING: If customer should use a BINDER chamber running in non-supervised continuous operation, we strongly recommend in case of inclusion of irrecoverable specimen or samples to split such specimen or samples and store them in at least two chambers, if this is feasible.
---	---

In case of foreseeable use of the chamber there is no risk for the user through the integration of the chamber into systems or by special environmental or operating conditions in the sense of EN 61010-1:2010. For this, the intended use of the chamber and all its connections must be observed.

1.7 Operating instructions

Depending on the application and location of the chamber, the operator of the chamber must provide the relevant information for safe operation of the chamber in a set of operating instructions.

	Keep these operating instructions with the chamber at all times in a place where they are clearly visible. They must be comprehensible and written in the language of the employees.
---	--

1.8 Measures to prevent accidents

The operator of the chamber must observe the following rule: “Betreiben von Arbeitsmitteln. Betreiben von Kälteanlagen, Wärmepumpen und Kühleinrichtungen“ (Operation of work equipment. Operation of refrigeration systems, heat pumps and refrigeration equipment) (GUV-R 500 chap. 2.35) (for Germany).

The manufacturer took the following measures to prevent ignition and explosions:

- **Indications on the type plate**

See operating manual chap. 1.4.

- **Operating manual**

An operating manual is available for each chamber.

- **Overtemperature monitoring**

The chamber is equipped with a temperature display, which can be read from outside.

The chamber is equipped with an additional safety controller (temperature safety device class 3.1 acc. to DIN 12880:2007). Visual and audible (buzzer) signals indicate temperature exceeding.

- **Safety, measurement, and control equipment**

The safety, measuring, and control equipment is easily accessible.

- **Electrostatic charge**

The interior parts are grounded.

- **Non-ionizing radiation**

Non-ionizing radiation is not intentionally produced, but released only for technical reasons by electrical equipment (e.g. electric motors, power cables, solenoids). The machine has no permanent magnets. If persons with active implants (e.g. pacemakers, defibrillators) keep a safe distance (distance of field source to implant) of 30 cm, an influence of these implants can be excluded with high probability.

- **Protection against touchable surfaces**

Tested according to EN ISO 13732-1:2008.

- **Floors**

See operating manual chap. 3.4 for correct installation

- **Cleaning**

See operating manual chap. 20.2.

- **Examinations**

The chamber has been inspected by the “Deutsche Gesetzliche Unfallversicherung e.V. (DGUV) (German Social Accident Insurance (DGUV)” (German Social Accident Insurance (DGUV), Testing and Certification Body for Foodstuffs and Packaging Industry in DGUV Test) and bears the GS mark.

1.9 Resistance of the humidity sensor against harmful substances

The following list of harmful substances refers only to the humidity sensor and does not include any other materials incorporated in the chamber or prohibited substances in relation to explosion protection.

Some gases - especially clean gases - do not have any influence on the humidity sensor. Others do have a very small influence, whereas others may influence the sensor to a larger extent.

- The following gases do not influence the sensor and the humidity measurement: Argon (Ar), carbon dioxide (CO₂), helium (He), hydrogen (H₂), neon (Ne), nitrogen (N₂), nitrous oxide (N₂O), oxygen (O₂)
- The following gases do not or to a minor extent influence the sensor and the humidity measurement: Butane (C₄H₁₀), ethane (C₂H₆), methane (CH₄), natural gas propane (C₃H₈)
- The following gases do not, or to a minor extent influence the sensor and the humidity measurement, provided that the indicated loads are not exceeded:

		Maximum work place threshold limit value		Tolerated concentration with permanent load	
Substance	Formula	ppm	mg/m ³	ppm	mg/m ³
Ammonia	NH ₃	20	14	5500	4000
Acetone	CH ₃ COCH ₃	500	1200	3300	8000
Benzene		300	1200		150000
Chlorine	Cl ₂	0.5	1.5	0.7	2
Acetic acid	CH ₃ COOH	10	25	800	2000
Ethyl acetate	CH ₃ COOC ₂ H ₅	400	1400	4000	15000
Ethanol	C ₂ H ₅ OH	500	960	3500	6000
Ethylene glycol	HOCH ₂ CH ₂ OH	10	26	1200	3000
Formaldehyde	HCHO	0.3	0.37	2400	3000
Isopropanol	(CH ₃) ₂ CHOH	200	500	4800	12000
Methanol	CH ₃ OH	200	260	3500	6000
Methyl ethyl ketone	C ₂ H ₅ COCH ₃	200	590	3300	8000
Ozone	O ₃	0.1	0.2	0.5	1
Hydrochloric acid	HCl	2	3	300	500
Hydrogen sulphide	H ₂ S	10	15	350	500
Nitrogen oxides	NO _x	5	9	5	9
Sulphur dioxide	SO ₂	5	13	5	13
Toluol	C ₆ H ₅ CH ₃	100	380	1300	5000
Xylene	C ₆ H ₄ (CH ₃) ₂	100	440	1300	5000

These values are to be considered as approximate values. The sensor resistance largely depends on the temperature and humidity conditions during the time of exposure to harmful substances. Avoid simultaneous condensation. Tolerated error of measurement: ± 2 %r.H. The maximum work place threshold limit value is one that can be regarded as harmless for humans.

- Vapors of oil and fat are dangerous for the sensor because they may condensate at the sensor and thus prevent its function (insulating layer). For similar reasons it is not possible to measure smoke gases.

2. Chamber description

The constant climate chambers KBF and KMF are equipped with a multifunctional microprocessor display controller with 2-channel technology for temperature and humidity plus a digital display accurate to one-tenth of a degree resp. 0.1% r.H. With its comprehensive program control functions, the display program controller MB2 permits the high precision performance of temperature and humidity cycles.

With its microprocessor controlled humidifying and dehumidifying system the KMF is a high-precision constant climate chamber.

The KBF completely meets the requirements for climatic chambers of the stipulated stability and durability tests for pharmaceutical products: Stability tests acc. to ICH guideline CPMP/ICH/2736/99 (Q1A)

The KMF completely meets the requirements of the stipulated stability and durability tests for industrial products.

The APT.line™ preheating chamber system guarantees high level of spatial and time-based temperature precision, thanks to the direct and distributed air circulation into the interior. The fan supports exact attainment and maintenance of the desired temperature accuracy.

Furthermore, it permits simulating exactly and over long periods constant conditions for other applications such as sample conditioning for material testing of paper, textiles, plastics, building materials, etc.

A resistance humidifying system humidifies the air. For this purpose, use deionized (demineralized) water. The option BINDER Pure Aqua Service allows using the chamber with any degree of water hardness.

The inner chamber, the pre-heating chamber and the interior side of the doors are all made of stainless steel V2A (German material no. 1.4301, US equivalent AISI 304). The housing is RAL 7035 powder-coated. All corners and edges are also completely coated.

All chamber functions are easy and comfortable to use thanks to their clear arrangement. Major features are easy cleaning of all chamber parts and avoidance of undesired contamination.

The efficient program controller is equipped with a multitude of operating functions, in addition to recorder and alarm functions. Programming of test cycles is easily accomplished via the modern MB2 touch screen controller and is also possible directly with a computer via Intranet in connection with the communication software APT-COM™ 3 DataControlSystem (option, chap. 19.1). The constant climate chamber KMF comes equipped with an Ethernet serial interface for computer communication. In addition, the BINDER communication software APT-COM™ 3 permits networking up to 30 chambers and connecting them to a PC for controlling and programming, as well as recording and representing temperature and humidity data. For further options, see chap.23.6.

The chambers size 240, 720, and 1020 are equipped with four castors. Both front castors can be easily locked via the attached brakes.

KBF: temperature range: 0 °C / 32 °F up to 70 °C / 158 °F, humidity range: 10% r.H. to 80% r.H.

KMF: temperature range -10 °C / 14 °F up to +100 °C / 212 °F, humidity range: 10 % r.H. to 98 % r.H.

For the control ranges of temperature and humidity, see climatic diagrams (chap. 17).

2.1 Chamber overview

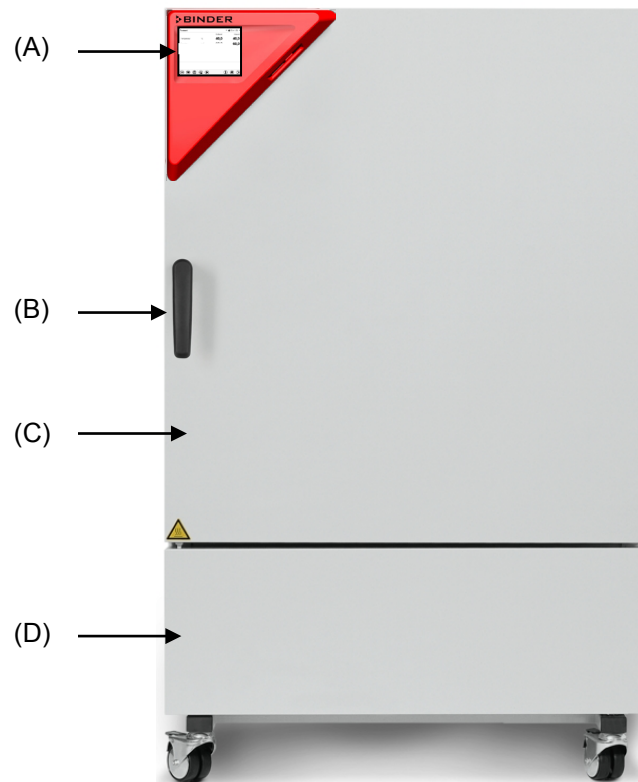

Figure 4: Constant climate chamber KBF / KMF size 240

- (A) Instrument box
- (B) Door handle
- (C) Outer door
- (D) Refrigerating machine and humidity generation module

2.2 Instrument panel

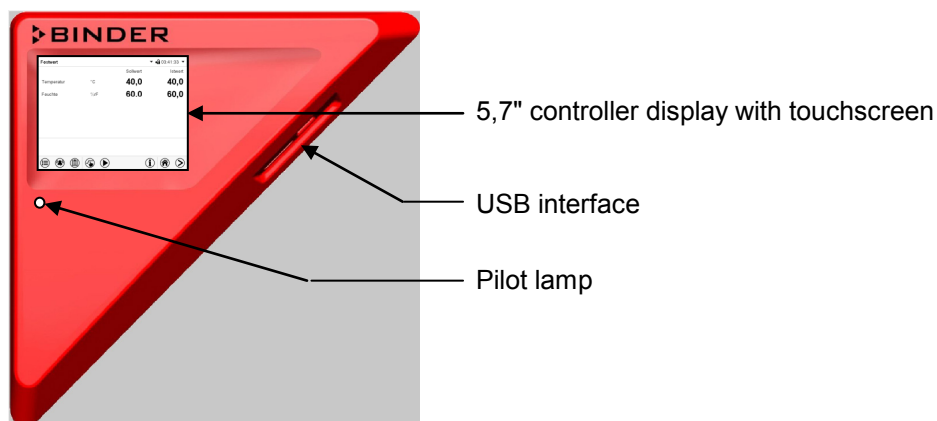

Figure 5: Instrument panel with MB2 program controller and USB interface

2.3 Lateral control panels

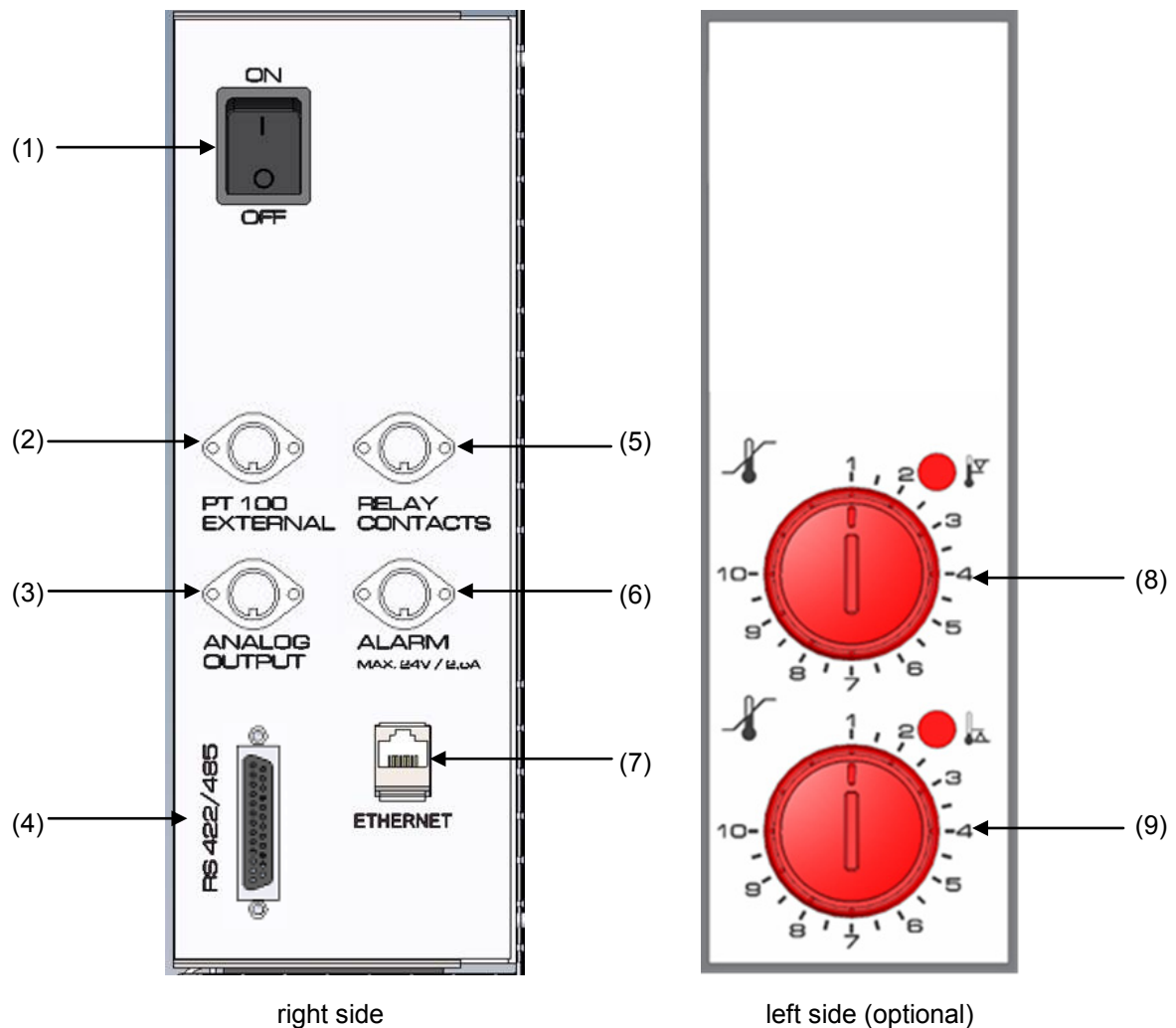

Figure 6: Lateral control panels at the sides of the refrigerating / humidity generation module with optional equipment

- (1) Main power switch
- (2) DIN socket for additional Pt 100 sensor (available via BINDER INDIVIDUAL customized solutions)
- (3) DIN socket for analog outputs (option)
- (4) RS485 interface
- (5) DIN socket for switching contacts (option for KMF)
- (6) DIN socket for zero-voltage relay alarm output (option)
- (7) Ethernet interface
- (8) Temperature safety device class 3.1 (part of option "Safety device class 3.3")
- (9) Temperature safety device class 3.2 (part of option "Safety device class 3.3")

2.4 Rear view with water connections

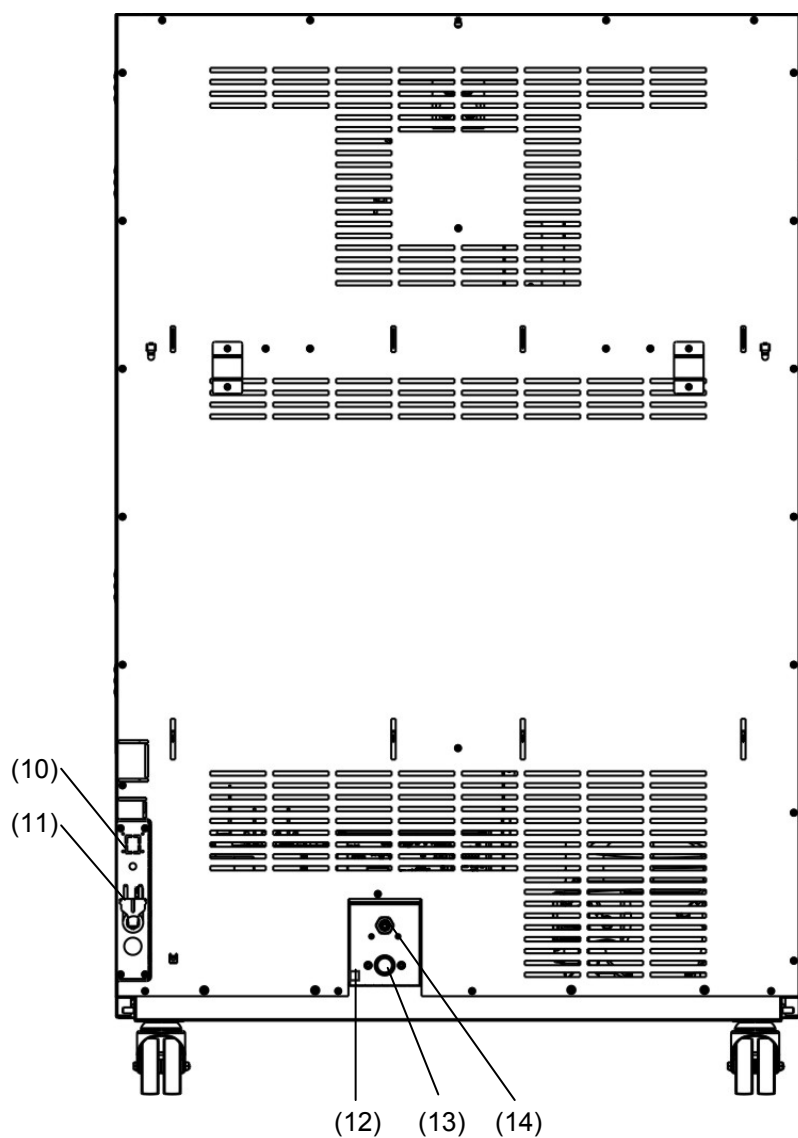

Figure 7: Rear view of the chamber with water connections

- (10) Socket for optional freshwater can (chap. 19.9.1)
- (11) Power cable
- (12) Purging outlet for humidifying module – for service purpose only
- (13) Freshwater connection “IN” with screw thread $\frac{3}{4}$ ” for hose $\frac{1}{2}$ ”, with union nut
- (14) Wastewater connection “OUT” with hose olive for hose $\frac{1}{2}$ ”





3. Completeness of delivery, transportation, storage, and installation

3.1 Unpacking, and checking equipment and completeness of delivery

After unpacking, please check the chamber and its optional accessories, if any, based on the delivery receipt for completeness and for transportation damage. Inform the carrier immediately if transportation damage has occurred.

The final tests of the manufacturer may have caused traces of the shelves on the inner surfaces. This has no impact on the function and performance of the chamber.

Please remove any transportation protection devices and adhesives in/on the chamber and on the doors and remove the operating manuals and accessory equipment.

   	 CAUTION
	<p>Sliding or tilting of the chamber.</p> <p>Damage to the chamber.</p> <p>Risk of injury by lifting heavy loads.</p> <ul style="list-style-type: none"> ⊘ Do NOT lift or transport the chamber using the door, the handle, or the lower housing. ➤ Lift chambers size 115 from the pallet at the four lower corners with the aid of four people ➤ Lift chambers size 240 from the pallet at the four lower corners with the aid of six people or with a fork lifter. Set the fork lifter only from the front or rear in the middle of the chamber. ➤ Lift the chambers sizes 720 and 1020 from the pallet using technical devices (fork lifter). Set the fork lifter only from the front or rear in the middle of the chamber. ⊘ Do NOT set the fork lifter from the chamber side.

If you need to return the chamber, please use the original packing and observe the guidelines for safe lifting and transportation (chap. 3.2).

For disposal of the transport packing, see chap. 21.1.





Note on second-hand chambers (Ex-Demo-Units):

Second-hand chambers are chambers that were used for a short time for tests or exhibitions. They are thoroughly tested before resale. BINDER ensures that the chamber is technically sound and will work flawlessly.

Second-hand chambers are marked with a sticker on the chamber door. Please remove the sticker before commissioning the chamber.

3.2 Guidelines for safe lifting and transportation

The front castors of KMF 240, 720 and 1020 can be blocked by brakes. After operation, please observe the guidelines for temporarily decommissioning the chamber (chap. 21.2). Please move the chambers with castors only when empty and on an even surface, otherwise the castors may be damaged.

   	 CAUTION
	<p>Sliding or tilting of the chamber.</p> <p>Damage to the chamber.</p> <p>Risk of injury by lifting heavy loads.</p>
	<ul style="list-style-type: none"> ➤ Transport the chamber in its original packaging only. ➤ For moving or shipping, secure the constant climate chamber with transport straps. ⊘ Do NOT lift or transport the chamber using the door, the handle, or the lower housing. ➤ Lift chambers size 115 at the four lower corners with the aid of 4 people ➤ Lift chambers size 240 at the four lower corners with the aid of 6 people or with a fork lifter. Set the fork lifter only from the front or rear in the middle of the chamber. ➤ Lift the chambers sizes 720 and 1020 using technical devices (fork lifter). Set the fork lifter only from the front or rear in the middle of the chamber. ⊘ Do NOT set the fork lifter from the chamber side.

You can order transport packing for moving or shipping purposes from BINDER service.

Permissible ambient temperature range during transport:

- If the steam humidifying system has NOT been emptied: +3 °C / 37.4 °F to +60 °C / 140 °F.
- After BINDER Service has emptied the steam humidifying system: -10 °C / 14 °F to +60 °C / 140 °F.

With temperatures below +3 °C / 37.4 °F, water must be completely removed from the humidifying system.

	CAUTION
	<p>Transport below +3 °C / 37.4 °F with filled steam humidifying system.</p> <p>Freezing in the steam generator.</p> <p>Damage to the chamber.</p> <ul style="list-style-type: none"> ➤ Contact BINDER Service before any transportation below +3 °C / 37.4 °F.

3.3 Storage

Intermediate storage of the chamber is possible in a closed and dry room. Observe the guidelines for temporary decommissioning (chap. 21.2).

Permissible ambient temperature range during storage:

- If the steam humidifying system has NOT been emptied: +3 °C / 37.4 °F to +60 °C / 140 °F.
- After BINDER Service has emptied the steam humidifying system: -10 °C / 14 °F to +60 °C / 140 °F

With temperatures below +3 °C / 37.4 °F, water must be completely removed from the humidifying system.

	CAUTION
	<p>Storage below +3 °C / 37.4 °F with filled steam humidifying system.</p> <p>Freezing in the steam generator.</p> <p>Damage to the chamber.</p> <p>➤ Contact BINDER Service before any transportation below +3 °C / 37.4 °F.</p>

Permissible ambient humidity: max. 70 % r.H., non-condensing

	CAUTION
	<p>Condensation by excess humidity.</p> <p>Danger of corrosion on the housing after operating at humidity values > 70 % r.H. for a long period.</p> <p>➤ Dry the chamber completely before shut-down:</p> <ul style="list-style-type: none"> • Set the humidity to 0 % r.H. To enable dehumidification, the humidifying and dehumidifying system must be activated (deactivated operation line "Humidity off", chap. 7.3 and setting "Control on", chap. 6.3). • Set the temperature set point to 60 °C / 140 °F for approx. 2 hours (Manual mode). • Only then, shut down the chamber at the main power switch (1) and close the tap of the water supply.

When after storage in a cold location you transfer the chamber to its warmer installation site, condensation may form. Before start-up, wait at least one hour until the chamber has attained ambient temperature and is completely dry.

3.4 Location of installation and ambient conditions

Set up the constant climate chamber on a flat, even surface, and in a well-ventilated, dry location and align it using a spirit level. The site of installation must be capable of supporting the chamber's weight (see technical data, chap. 23.5). The chambers are designed for setting up inside a building (indoor use).

	CAUTION
	<p>Danger of overheating.</p> <p>Damage to the chamber.</p> <p>⊘ Do NOT set up chamber in non-ventilated recesses.</p> <p>➤ Ensure sufficient ventilation for dispersal of the heat.</p>

- **Permissible ambient temperature range during operation:** +18 °C / 64.4 °F to +32 °C / 89.6 °F. At elevated ambient temperature values, fluctuations in temperature can occur.

	<p>The ambient temperature should not be substantially higher than the indicated ambient temperature of +22 °C +/- 3 °C / 71.6 °F ± 5.4 °F to which the specified technical data relate. Deviations from the indicated data are possible for other ambient conditions. Lower values of the temperature range indicated in the technical data are valid at an ambient temperature of max. 25 °C / 77 °F.</p>
---	---

	<p>With each degree of ambient temperature >25 °C / 77 °F, the refrigeration power decreases by 1.5 K.</p>
---	---

- **Permissible ambient humidity:** 70 % r.H. max., non-condensing

When operating the chamber at temperature set-points below ambient temperature, high ambient humidity may lead to condensation on the chamber.

- Installation height: max. 2000 m / 6562 ft. above sea level.

A water tap (1 bar to 10 bar) is necessary for the installation of the humidification system (chap. 4.3). If no suitable in-house water connection is available, you can manually supply water by filling the freshwater can (option, chap. 19.9).

	To avoid any possible water damage, provide a floor drain at the location of the device. Select a suitable installation site to avoid any consequential damage by splashing water.
---	--

When placing several chambers of the same size side by side, maintain a minimum distance of 250 mm / 9.84 in between each chamber. Wall distances: rear 100 mm / 3.9 in, sides 160 mm / 6.29 in. Spacing above the chamber of at least 100 mm / 3.9 in must also be accounted for.

	CAUTION
	<p>Danger by stacking.</p> <p>Damage to the chambers.</p> <p>⊘ Do NOT place the chambers on top of each other.</p>



To completely separate the chamber from the power supply, you must disconnect the power plug. Install the chamber in a way that the power plug is easily accessible and can be easily pulled in case of danger.

For the user there is no risk of temporary overvoltages in the sense of EN 61010-1:2010.

With an increased amount of dust in the ambient air, clean the condenser fan (by suction or blowing) several times a year.

Avoid any conductive dust in the ambiance according to the chamber layout complying with pollution degree 2 (IEC 61010-1).

Do not install or operate the chamber in potentially explosive areas.

	 DANGER
	<p>Explosion hazard.</p> <p>Danger of death.</p> <p>⊘ Do NOT operate the chamber in potentially explosive areas.</p> <p>➤ KEEP explosive dust or air-solvent mixtures AWAY from the vicinity of the chamber.</p>

After turning off the chamber, you must close the tap of the water supply. Install the chamber in a way that the freshwater supply is easily accessible.

In case of a prolonged temporal decommissioning: Leave the chamber door open or remove the access port plugs.

4. Installation and connections

4.1 Spacer for wall distance

Please fix both spacers with the supplied screws at the chamber rear. This serves to ensure the prescribed minimum distance to the rear wall of 100 mm / 3.94 in.



Figure 8: Spacer for wall distance

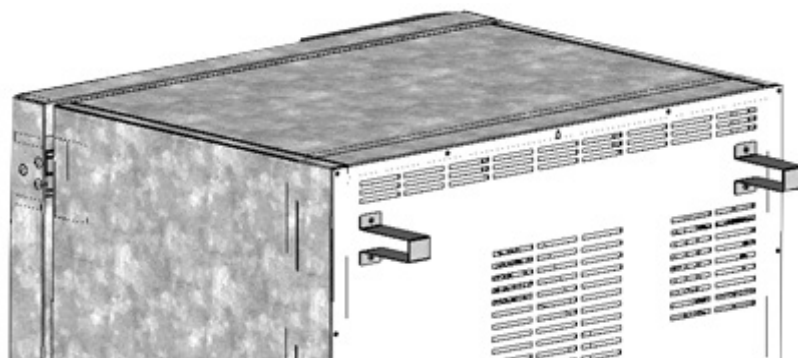

Figure 9: Rear KMF with mounted spacers

4.2 Wastewater connection

Fasten the wastewater hose to the wastewater connection "OUT" (14) on the rear of the chamber (olive \varnothing 14 mm). Observe the following points:

- You can use a part of the supplied water hose as a drainage hose. In case another hose is used, it has to be permanently resistant against at least 95 °C / 203 °F.
- Mount the wastewater hose with a maximum positive inclination of 1 m and a maximum total length of 3 m.
- Protect the chamber end of the drainage hose with one of the supplied hose clamps.
- Reliably prevent sucking back of wastewater. The end of the wastewater hose must not be immersed in liquids. This can be ensured e.g., by free discharge.



Waste water is collected in an internal can with a volume of approx. 0.5 liters. It is pumped off only when required, thus there is no continuous waste water flow.



Protect the waste water supply with the supplied hose clamps.

4.3 Freshwater supply



Connect the waste water pipe before connecting the chamber to a freshwater pipe or filling the freshwater can (option, chap. 19.9).

You can supply the chamber with freshwater via a water pipe or by manually filling a freshwater can (option, chap. 19.9).



Water intake temperature NOT below +5 °C / 41 °F and not exceeding 40 °C / 104 °F.



CAUTION

Calcification of the humidifying system.

Damage to the chamber.

➤ Operate the chamber with deionized (demineralized) water only.

Types of suitable water quality:

- Deionized water from a water treatment installation already existing at the customer's site. Conductivity from 1 µS /cm up to a maximum of 20 µS/cm. (Water, which is in equilibrium with the CO₂ in the air, and has a conductivity below 1 µS/cm (ultrapure water), may cause acid corrosion due to its low pH.)
- Water treated by the optional water treatment system BINDER Pure Aqua Service (disposable system). A reusable measuring equipment to assess the water quality is included (chap. 19.10).



BINDER GmbH is NOT responsible for the water quality at the user's site.

Any problems and malfunctions that might arise following use of water of deviating quality is excluded from liability by BINDER GmbH.

The warranty becomes void in the event of use of water of deviating quality.

4.3.1 Automatic fresh water supply via water pipe

An enclosure inside the chamber contains the connection kit for freshwater and wastewater. Install the freshwater connection using either the enclosed water hose or another pressure-resistant one. To accomplish this, remove the cover of the freshwater connection "IN" (13) on the rear of the chamber. Protect both ends of the hose with two of the four supplied hose clamps.

Before turning on the chamber, check the connection for leaks. Water supply is automatically effected via the freshwater connection "IN" (13).



As the appliance only lets in water when required, there is no continuous water flow.



- Supply pressure 1 to 10 bar when connecting to a water pipe
- Water type: deionized (demineralized) water
- Water intake temperature NOT below +5 °C / 41 °F and not exceeding 40 °C / 104 °F.
- The water intake should be provided with a shut-off slide or water-tap.
- For the water supply, fix the delivered adapter with hose olive on the thread at the rear of the chamber.
- Protect the water supply at one side with the supplied hose clamp.

4.3.2 Manual fresh water supply via external freshwater can (option)

If no house water connection with suitable water is available, you can manually supply water by filling a freshwater can (option, volume: 20 liters / 0.71 cu.ft. You can attach the freshwater can on the rear of the chamber or place it next to the chamber (chap. 19.9).



To guarantee humidification during 24 hours even at high humidity set-points with manual water supply, we recommend filling the freshwater can (option) daily at the end of the day.

4.3.3 Connection kit for connecting the chamber to the water main

A safety kit against flooding caused by burst water hoses is enclosed with the constant climate chamber. It consists of the following:

- Hose burst protection device
- 2 hose nozzles with screwing
- 4 hose clamps
- 6m water hose, divisible for the feed hose and drain

Protection principle of hose burst protection:

Whenever a strong water flow of about 18 l / min. occurs, e.g. caused by a burst water hose, a valve automatically cuts off the water supply, which can be heard as a clicking noise. The water supply now remains shut until it is manually released.

Assembly:

Screw the hose burst protection device onto a water tap with a G $\frac{3}{4}$ inch right turning thread connection. The connection is self-sealing. Establish the connection between the safety kit and the chamber with a part of the supplied hose. Protect both ends of the hose by the supplied hose clamps.

We recommend connecting the hose as the last step in order to avoid twisting the hose while screwing on the safety kit.

Open the water tap slowly in order to avoid actuating the hose burst protection device.

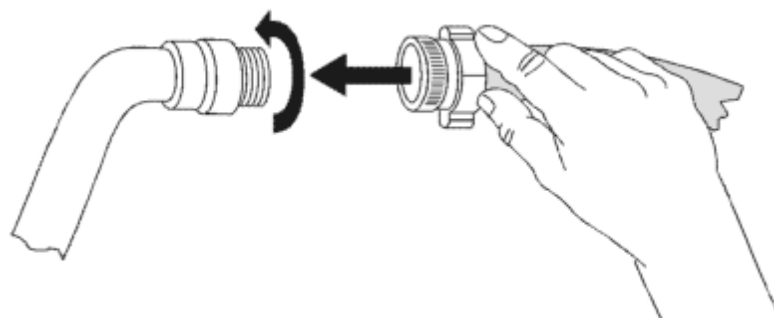



Figure 10: Assembly of the connection kit

Release of the reflux protection device:

In case the burst protection device has interrupted the water supply, first find the reason and remove it as necessary. Close the water tap. Release the valve by a half left-turn of the upper knurled part. You can hear the release of the valve as a clicking noise. Tighten the burst protection device against the water tap by a right turn. Open the water tap slowly afterwards.

Maintenance of the assembly of the hose burst protection device:

Calcification can impair valve function. We recommend an annual inspection by a skilled plumber. The plumber should demount the safety kit to check the valve by hand for function, calcification or blockage.

	CAUTION
	<p>Danger of calcification.</p> <p>Impairment of valve function.</p> <ul style="list-style-type: none"> ➤ Have a plumber inspect the valve annually. ➤ Remove calcifications by citric acid or acetic acid solutions. ➤ Continue by testing the function and tightness of the mounted chamber

Check: Quickly open the water tap while there is no chamber connected – the valve should cut off the water flux without any delay.

4.3.4 Safety kit: Hose burst protection device with reflux protection device (available via BINDER INDIVIDUAL customized solutions)

A safety kit with a reflux protection device is available for protection of the drinking water system, and against flooding caused by burst water hoses.

Protection principles:

Whenever a strong water flow of about 18 l / min. occurs, e.g. caused by a burst water hose, a valve automatically cuts off the water supply, which can be heard as a clicking noise. The water supply now remains shut until it is manually released.

A possible endangering of the drinking water system depends on the risk potential of the charging material. Under unfavorable conditions (e.g. decreasing pressure inside the tap water system), drained off charging material could be sucked out of the chamber via the steam generator into the tap water system and therefore contaminate the drinking water. The safety kit with reflux protection device provides security in case of short-term utilization of substances with low risk potential. When using substances bearing a higher risk potential, install a pipe disconnecter to assure absolute protection. It is the user's responsibility to prevent (according to national standards) any reflux of contaminated water from getting into the drinking water system.

Assembly:

The standard supplied parts – hose burst protection device, hose nozzle with screwing – are not needed.

Screw the pre-mounted assembly of the hose burst protection and reflux protection devices onto a water tap with a G³/₄ inch right turning thread connection. The connection is self-sealing. Establish the connection between the safety kit and the chamber with a part of the supplied hose. Protect both ends of the hose with the supplied hose clamps.

We recommend connecting the hose as the last step in order to avoid twisting it while screwing on the safety kit.

Open the water tap slowly in order to avoid actuating the hose burst protection device.

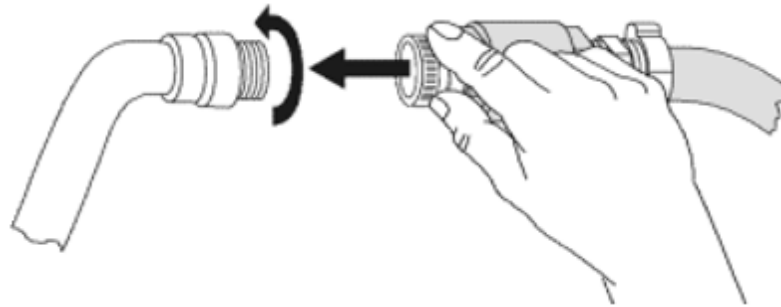



Figure 11: Assembly of the safety kit (hose burst protection and reflux protection devices)

Release of the reflux protection device:

In case the hose burst protection device interrupts the water supply, first find the reason and remove it as necessary. Close the water tap. Release the valve by a half left-turn of the upper knurled part. You can hear the release of the valve as a clicking noise. Tighten the burst protection device against the water tap by a right turn. Open the water tap slowly afterwards.

Maintenance of the assembly of hose burst protection and reflux protection devices:

Calcification can impair the function of both valves. We recommend an annual inspection by a skilled plumber. The plumber should remove the safety kit with the reflux protection device to check both valves by hand for proper function and calcification or blockage.

	CAUTION
	<p>Danger of calcification.</p> <p>Impairment of valve function.</p> <ul style="list-style-type: none"> ➤ Have a plumber inspect the two valves annually. ➤ Remove calcifications by citric acid or acetic acid solutions. ➤ Continue by testing the function and tightness of the mounted chamber.

Check: Quickly open the water tap while there is no chamber connected – the valve should cut off the water flux without any delay.

4.4 Electrical connection

The chambers are supplied ready for connection. They come with a fixed power connection cable of at least 1800 mm / 70.87 in in length.

Model version	Art. No. (x = 0 or 1)	Power plug	Voltage +/-10% at the indicated power frequency	Current type	Chamber fuse
KBF115-230V KBF240-230V KBF720-230V KBF1020-230V	9x20-0320 9x20-0322 9x20-0324 9x20-0326	Shock-proof plug	200-230 V at 50 Hz 200-230 V at 60 Hz	1N~	16 Amp
KBF115-240V KBF240-240V KBF720-240V KBF 1020-240V	9x20-0321 9x20-0323 9x20-0325 9x20-0327	NEMA 6-20P	200-240 V at 50Hz 200-240 V at 60Hz	2~	16 Amp
KMF115-230V KMF240-230V KMF720-230V	9x20-0341 9x20-0343 9x20-0345	Shock-proof plug	200-230 V at 50 Hz 200-230 V at 60 Hz	1N~	16 Amp
KMF115-240V KMF240-240V KMF720-240V	9x20-0342 9x20-0344 9x20-0346	NEMA 6-20P	200-240 V at 50Hz 200-240 V at 60Hz	2~	16 Amp



- The socket must also provide a protective conductor.
- Prior to connection and start-up, check the power supply voltage. Compare the values to the specified data located on the chamber's type plate (left chamber side, bottom right-hand, see chap. 1.4).
- When connecting, please observe the regulations specified by the local electricity supply company and as well as the VDE directives (for Germany). We recommend the use of a residual current circuit breaker.
- Pollution degree (acc. to IEC 61010-1): 2
- Installation category (acc. to IEC 61010-1): II

	CAUTION
	<p>Danger of incorrect power supply voltage. Damage to the equipment.</p> <ul style="list-style-type: none"> ➤ Check the power supply voltage before connection and start-up. ➤ Compare the power supply voltage with the data indicated on the type plate.

See also electrical data (chap. 23.5).

	To completely separate the chamber from the power supply, you must disconnect the power plug. Install the chamber in a way that the power plug is easily accessible and can be easily pulled in case of danger.
---	---

Remark when operating the chamber with a power frequency of 60 Hz:

	 WARNING
	<p>High leakage current. Electrical hazard.</p> <ul style="list-style-type: none"> ➤ Earth connection essential before connecting supply. Check socket before inserting plug.

When connected to a power supply 1N~ with a frequency of 60 Hz, a leakage current of more than 3.5 mA is possible. If grounding through the power cable is insufficient or missing, the leakage current may flow through the user's body. Correct installation of the professional grade power socket provided by the user safely avoids this. Before connecting the chamber to the socket, please check its grounding contact type plug for appropriate construction and if it is undamaged.

4.5 Connection of the voltage changer (option for KBF)

The voltage changer enables the constant climate chamber to operate at a power frequency of 115 Volt. It is packed separately and supplied together with the constant climate chamber.

The voltage changer is supplied with a fixed power connection cable with a NEMA 5-20P plug. It is protected against excess-current with an internal over-current release category B16A. The connection is made by the customer.

	<div style="background-color: yellow; text-align: center; padding: 5px;">CAUTION</div> <p>Sliding or tilting of the voltage changer. Damage to the voltage changer.</p> <p>Risk of injury by lifting heavy loads.</p> <ul style="list-style-type: none"> ➤ Lift the voltage changer at both carrying handles from the pallet with two persons.
---	--

Do not install the voltage changer in the exhaust air flow at the rear of the constant climate chamber.

For the installation of the voltage changer next to the constant climate chamber, provide a wall distance the alternating climate chamber of approx. 0.4 m / 1.3 ft.

	<div style="background-color: yellow; text-align: center; padding: 5px;">CAUTION</div> <p>Danger of overheating. Damage to the voltage changer.</p> <ul style="list-style-type: none"> ⊘ Do NOT install the voltage changer in unventilated recesses. ➤ Ensure sufficient ventilation for dispersal of the heat.
---	--

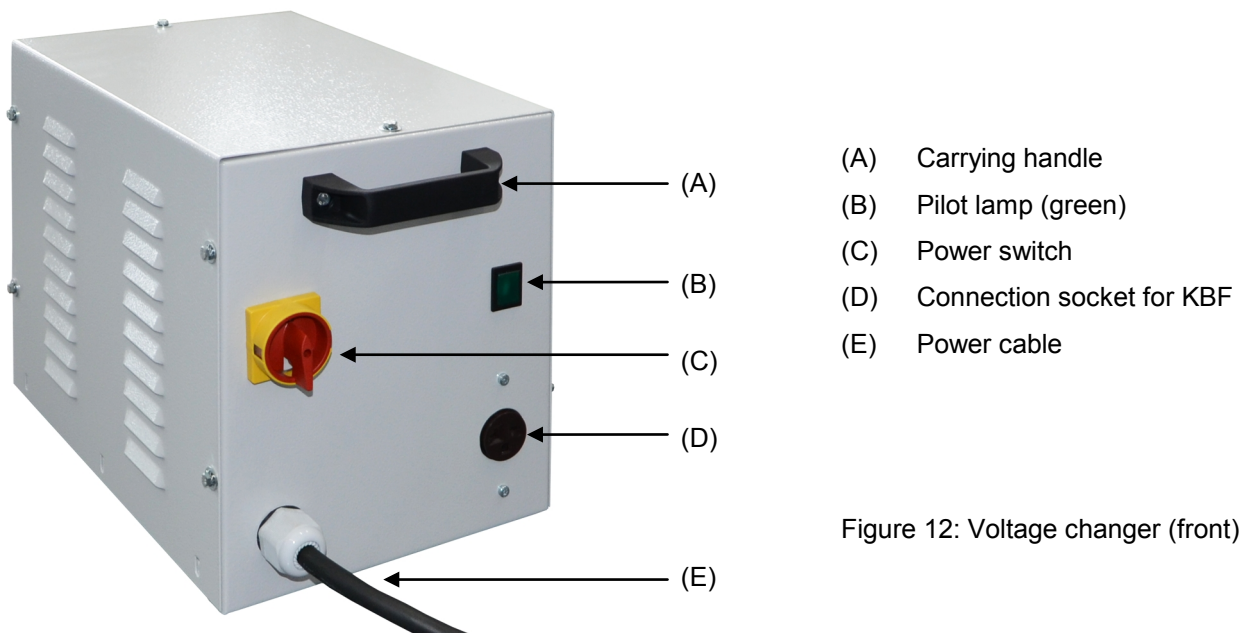

To establish the electrical connection of the constant climate chamber with the voltage changer, proceed in the following order:

1. Connect the power cable of the constant climate chamber to the connection socket (D) of the voltage changer
2. Establish the power connection of the voltage changer. The socket must provide a protective conductor.
3. Turn on the voltage changer at the power switch (C) (position "I"). The green pilot lamp (B) lights up.
4. Turn on the constant climate chamber with the main power switch (1) in the lateral control panel

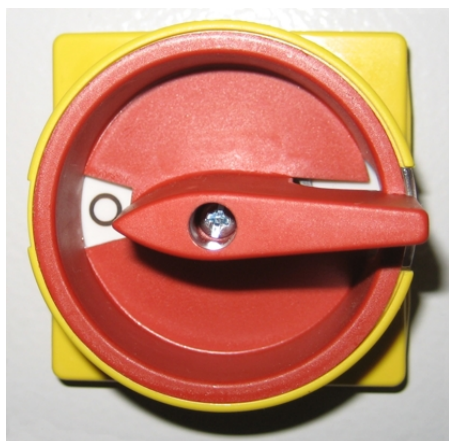

Position "0" = off

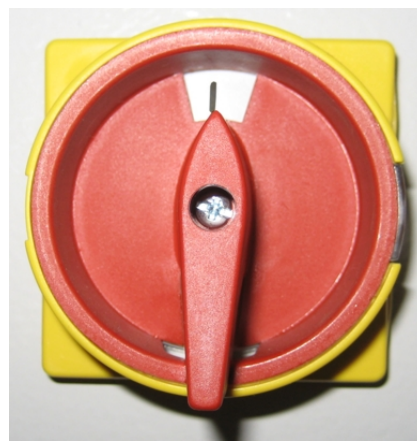

Position "I" = on

Figure 13: Power switch of the voltage changer

Dimensions of the voltage changer		
Width	mm	255
Depth (without door handles)	mm	360
Depth (incl. cable and door handles)	mm	450
Height	mm	300
Length of the connection cable to wall socket	mm	172
Lateral wall clearance of the constant climate chamber to set up the voltage changer (minimum)	mm	400
Electrical connection data of the voltage changer		
Input side	V	115
	A	26,9
Output side (to the chamber)	V	214
	A	13,0
Power frequency	Hz	50 / 60

5. Functional overview of the MB2 chamber controller

The MB2 chamber controller controls following parameters inside the chamber: temperature and humidity (closed loop control), and fan speed.

Channel 1: Temperature in °C

Channel 2: Relative humidity in % r.H.

For the control ranges of temperature and humidity, see climatic diagrams (chap. 17).

You can enter the desired set point values in fixed value operation mode directly on the display surface or via the setpoint menu. For program operation the controller offers programming week and time programs. In addition there is a timer program available (stopwatch function).

The controller offers various notifications and alarm messages with visual and audible indication and remote alarms via e-mail, an event list (trace file) and the graphical display of the measuring values in the in der chart recorder view. The MB2 program controller permits programming temperature and humidity cycles. You can enter values or programs directly at the controller or use the APT-COM™ 3 DataControl-System software (option) specially developed by BINDER.

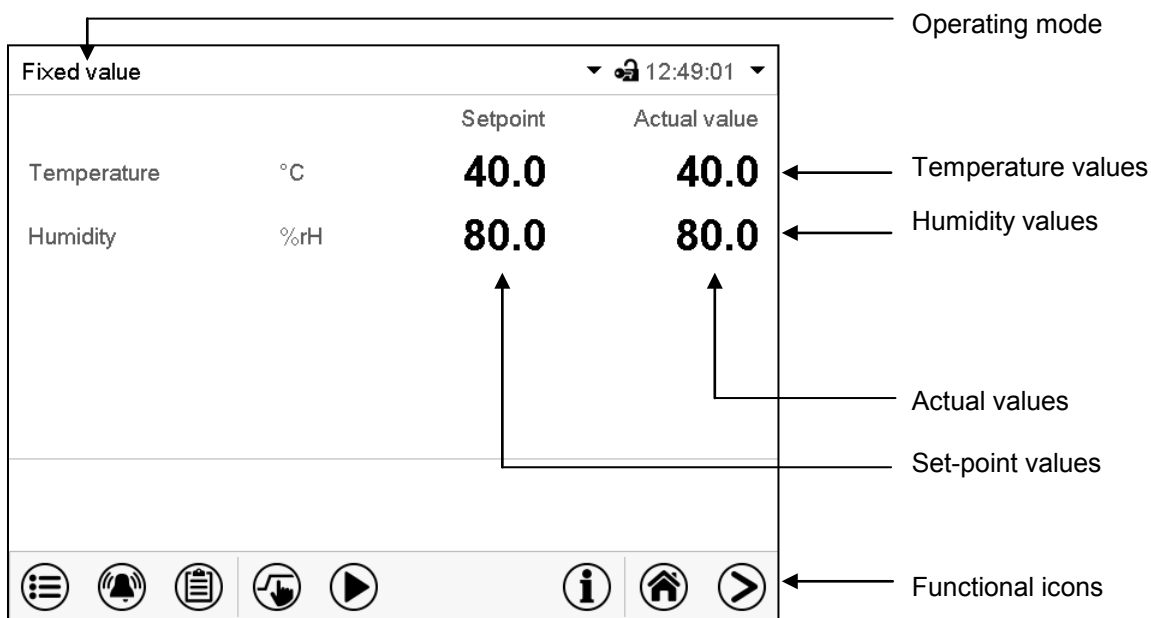

Figure 14: Normal display of the MB2 program controller (sample values)

5.1 Operating functions in normal display

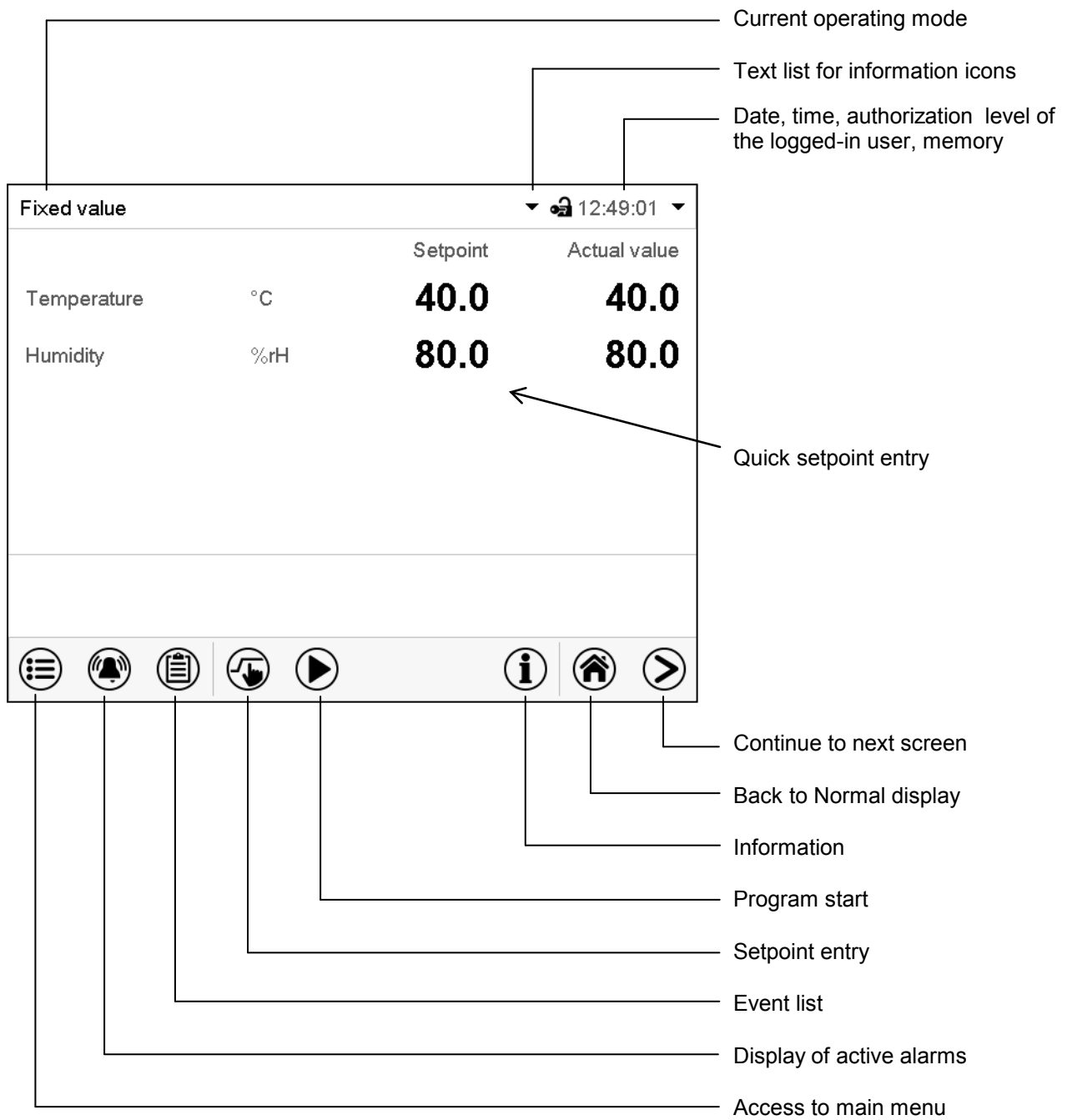

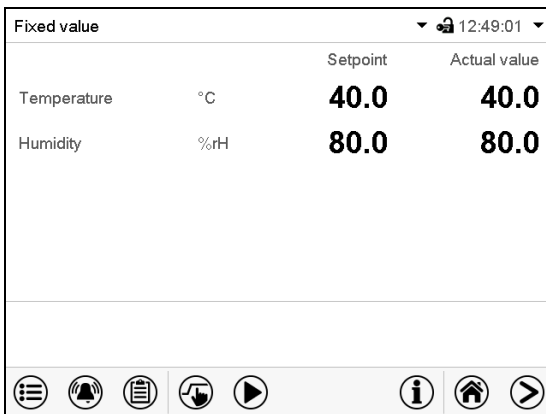

Figure 15: Operating functions of the MB2 controller in normal display (example values)

5.2 Display views: Normal display, program display, chart-recorder display

	Press the Change view icon to toggle between normal display, program display and chart-recorder display.
	Press the Normal display icon to return from program display and chart recorder display back to Normal display.



Normal display (actual values / setpoint values)

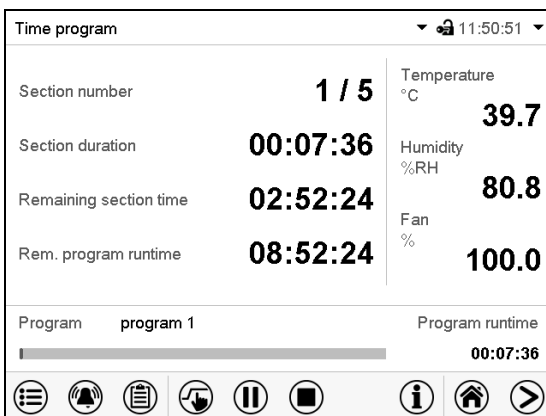

Program display (example: time program)

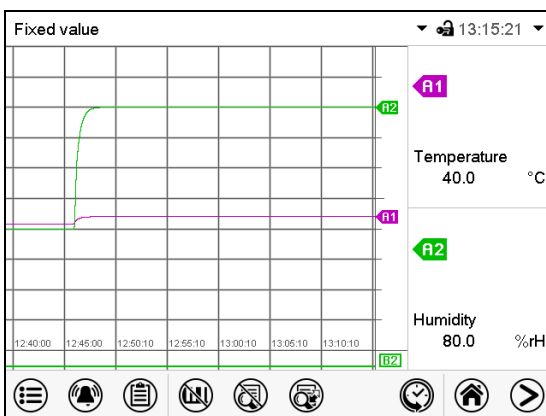

















Chart recorder display

5.3 Controller icons overview







Navigation icons in Normal display

Icon	Signification	Function
	Main menu	Access from Normal display to the main menu
	Alarm	Access from Normal display to the list of active alarms
	Event list	Access from Normal display to the event list
	Setpoint setting	Access from Normal display to the setpoint entry menu: setpoint entry for Fixed value operation, turning on/off humidity control, safety controller settings
	Program start	Start a previously entered time or week program, continue a paused time program
	Program pause	Pause a running time program
	Program cancelling	Cancel a running time or week program
	Information	Information on program operation, setpoints, actual values, and the safety controller
	Normal display	Return from program display or chart recorder display to Normal display
	Change view	Toggle between Normal display, program display, and chart recorder display











Functional icons in individual menus

Icon	Signification	Function
	Back	Return from each menu to Normal display
	Update	Update the event list and alarm messages
	Confirm	Take over the entries and exit the menu / continue menu sequence.
	Close	Exit the menu / cancel menu sequence. Entries are not taken over. When terminating a menu sequence, an information window appears, which must be confirmed.
	Change keyboard	Change between uppercase and lower case characters, digits and special characters
	Edit	Edit settings of time and week programs

Information icons

Icon	Signification	Information
	Idle mode	Controller in Idle mode
	Temperature range	Current actual temperature value outside the tolerance range
	Humidity range	Current actual humidity value outside the tolerance range
	Door open	Chamber door is open
	Humidity off	The humidification / dehumidification system is turned off
	Reset alarm	Acknowledge the alarm and mute the buzzer.

Functional icons in the chart recorder display

Symbol	Function
	Show legend on the right side of the display
	Hide legend
	Switch between legend pages
	Show indication "Door open" (B2)
	Hide indication "Door open" (B2)
	Pause chart recorder. Data recording continues.
	Go to "Curve selection" submenu
	Go to "Search" submenu
	Go to "Zoom" submenu
	Show arrow keys to select instant
	Hide arrow keys

Information icon in the touchscreen calibration menu

Symbol	Information
	Remaining time to touch the display when calibrating the touchscreen.

5.4 Operating modes

The MB2 program controller operates in the following operating modes:

- **Idle mode**

The controller is not functional, i.e., there is no heating or refrigeration and no humidification or dehumidification. The fan is off. The chamber approximates ambient values.

You can activate and deactivate this operating mode with the “Idle mode” control contact in Fixed value operating mode (chap. 7.3), time program operation (chap. 9.7.3) and week program operation (chap. 10.6.7).

- **Fixed value operating mode**

The controller operates as a fixed-point controller, i.e., set-points for temperature and humidity can be defined, which are then maintained until the next manual change (chap. 7.1).

- **Timer program operation**

Stopwatch function: during an entered duration the controller constantly equilibrates to the setpoints entered in Fixed value operation mode.

- **Time program operation**

An entered time program for temperature and humidity is running. The controller offers 25 program memory places with 100 program sections each. The total number of program sections of all programs is unlimited

- **Week program operation**



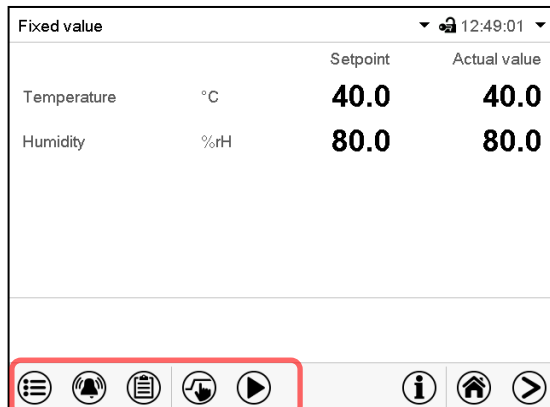

An entered week program for temperature and humidity is running. The controller offers 5 program memory places with 100 switching points each. The switching points can be distributed over all days of the week.

5.5 Controller menu structure

Use the **navigation icons** in the screen footer in Normal display to access the desired controller functions.





The available functions depend on the current **authorization level** "Service", "Admin" or "User" (chap. 13.1). This is selected either during login or can be available without password protection.

	Main menu: program settings, further information, "Service" submenu. The "Settings" submenu allows general configuration of the controller.	chap. 5.5.1
	List of active alarms	chap. 11
	Access to the event list	chap. 15.2
	Setpoint entry for Fixed value operation, turning on/off humidity control , safety controller settings	chap. 7, 6.3, 12.2
	Start/ pause/ cancel an already entered, respectively a running time program or start / cancel an already entered, respectively a running week program	chap. 9.1, 9.2, 10.1



Unless noted otherwise, the figures show the functional range, which is available for the user with "Admin" authorization level.

5.5.1 Main menu

The main menu provides access to the general configuration of the controller as well as to program entry and the user administration. Additionally there are support functions like a contact page or the display calibration depending on the available angle.

	Press the Main menu icon to access the main menu from Normal Display.
	Press the Back icon to return from each setting menu to Normal Display.

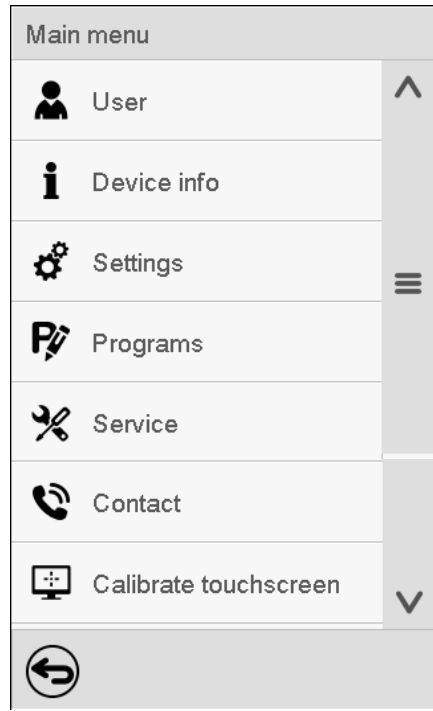
The main menu provides the following functions and submenus.

			
	User	User management: login and logout, password management	chap. 13
	Device info	Chamber information	chap. 15.2
	Settings	“Settings” submenu (not visible for user with “User” authorization level)	chap. 14
	Programs	Program entry submenu for time and week programs	chap. 9 and 10
	Service	“Service” submenu	chap. 5.5.3
	Contact	BINDER Service contact page	chap. 15.1
	Calibrate touchscreen	Calibrating the touch screen	chap. 14.4.2
	Back to Normal Display		

“Settings” submenu

- Settings of many general controller functions and network settings (chap. 14).
- Available only for users with “Service” and “Admin” authorization level

“Service” submenu

- Access to service data, controller reset to factory settings (chap. 5.5.3)
- Available only for users with “Service” and “Admin” authorization level. Full functional range only for BINDER Service (users with “Service” authorization level).

“Programs” submenu

- Access to the controller’s program functions (chap. 8, 9, 10)

5.5.2 “Settings” submenu

The “Settings” submenu is available for users with “Service” or “Admin” authorization level. It serves to enter date and time, select the language for the controller menus and the desired temperature unit and to configure the controller’s communication functions.

Path: **Main menu > Settings**

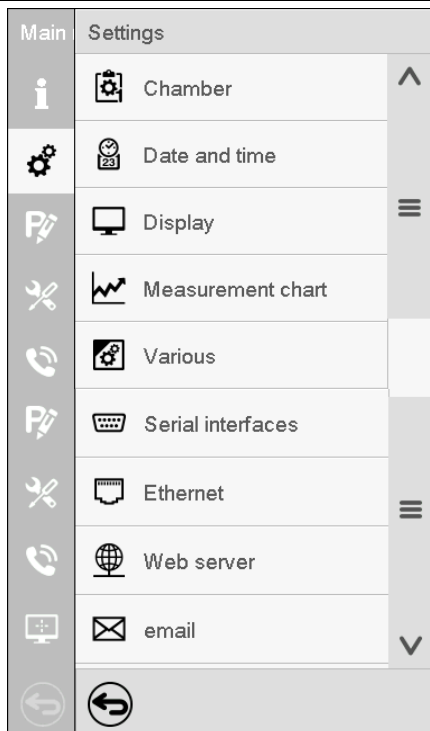
	Settings		
	Chamber	Setting the temperature unit, menu language...	chap. 14.1, 14.2
	Date and time	Setting date and time	chap. 14.3
	Display	Setting the display brightness, continuous operation and screen saver	chap. 14.4
	Measurement chart	Settings for the measurement chart: storage interval, storage values, minimum and maximum values	chap. 16.2
	Various	Setting the tolerance range and delay time for tolerance range alarm	chap. 11.4
	Serial interfaces	Configuration of the optional RS485 interface, setting of the device address	chap. 14.5.1
	Ethernet	Entry of the MAC address and IP address	chap. 14.5.2
	Web server	Password protection for web server access	chap. 14.5.3
	email	Configuration of the e-mail server, assignment of e-mail addresses	chap. 14.5.4
		Back to main menu	

5.5.3 “Service” submenu

The “Service” submenu is available for users with “Service” or “Admin” authorization level. When logged-in with “Admin” authorization level the user will find information to tell the BINDER Service in service case.

Path: **Main menu > Service**

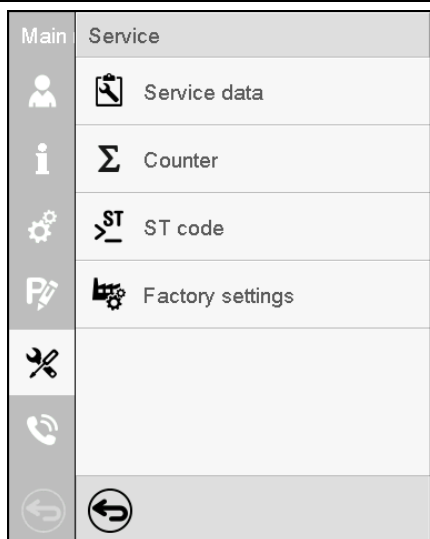
	Service		
	Service data	Serial number of the chamber, setup version of the controller software	chap. 14.2
	Counter	No function	
	ST code	Information for BINDER Service	
	Factory settings	Reset to factory settings	
		Back to main menu	

(view with “Admin” authorization level)

5.6 Principle of controller entries

In the selection and entry menus there are icons displayed in the footers which you can use to take over the entry or cancel it.

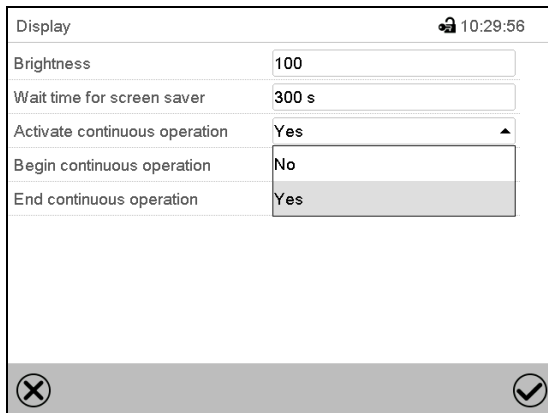

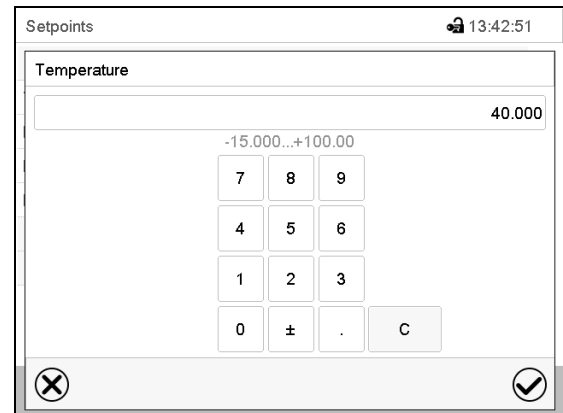

Selection menu (example)



Entry menu (example)

There are the following possibilities:

	Press the Confirm icon to take over the entries and exit the menu or continue the menu sequence.
	Press the Close icon to exit the menu or cancel the menu sequence without taking over the entries. When terminating a menu sequence, an information window appears, which must be confirmed.

5.7 Performance during and after power failures

During a power failure, all controller functions are shut down. The zero-voltage relay alarm output (option, chap. 19.5) is switched to alarm position for the whole duration of the power failure.

After the power returns, all functions return to the same status the chamber had before power failure. . The controller continues to function in the original operating mode it was in previously before the power failure occurred.

- Performance after power failure in Idle mode
Control is deactivated
- Performance after power failure in Fixed value operation mode
All functions return to the same status the chamber had before power failure. The set-points are immediately resumed.
- Performance after power failure during time program operation
The program is resumed at the point where the interruption occurred with the latest set-points reached during the program run.
- Performance after power failure during week program operation
The week program continues with the values corresponding to the current time.

Power failure and power return are noted in the event list (chap. 15.3).

If during power failure an alarm has occurred (tolerance range, safety controller, temperature safety device class 3.3 (option), confirm the alarm. See chap. 11.3.

5.8 Performance when opening the door

When you open the door the fan starts running with minimum speed.

After 60 seconds from opening the door, heating, refrigeration, humidification, dehumidification and fan turn off.

After closing the door, heating, refrigeration, humidification, dehumidification and fan turn on again.

6. Start up

6.1 Turning on the chamber

After connecting the supply lines (chap. 4), turn on the chamber by its main power switch (1). The lit pilot lamp shows the chamber is ready for operation.

When the main power switch is turned on and yet the controller display is dark, the display is in stand-by mode. Press on the touchscreen to activate it.

- Open the water-tap for freshwater supply. Alternatively, fill the freshwater can (option, chap. 19.9).
- The humidifying and dehumidifying system must be activated (deactivated operation line “Humidity off”, chap. 7.3 and setting “Control on”, chap. 6.3).

After the first turning on of the chamber or after an interruption of the power supply the relative humidity will increase after a delay of about 20 minutes. During this period, the relative humidity can drop considerably.

Warming chambers may release odors in the first few days after commissioning. This is not a quality defect. To reduce odors quickly we recommend heating up the chamber to its nominal temperature for one day and in a well-ventilated location.



WARNING: If customer should use a BINDER chamber running in non-supervised continuous operation, we strongly recommend in case of inclusion of irrecoverable specimen or samples to split such specimen or samples and store them in at least two chambers, if this is feasible.

6.2 Controller settings upon start up

The window „Language selection“ enables the **language selection**, in case that it's activated in the “Start-up” menu. Afterwards occurs a request of the **time zone** and the **temperature unit**.

Language selection	
German	<input checked="" type="checkbox"/>
English	<input type="checkbox"/>

Start-up	
Temperature unit	Degrees Celsius
Time zone	UTC+1h (CET)
Daylight saving time switch	Automatic
▼ Start of daylight saving time	
▼ End of daylight saving time	
Language query after restart	Yes

The controller will function in the **operating mode**, which was active before the last shut-down. It controls temperature and humidity in fixed value operating mode to the last entered values and in the program mode to the set points achieved beforehand.

Locked operation

Provided that the user administration has been activated by the assignment of passwords for the different authorization types, the **controller operation** is first locked after turning on the unit, recognizable by the closed lock icon in the header.

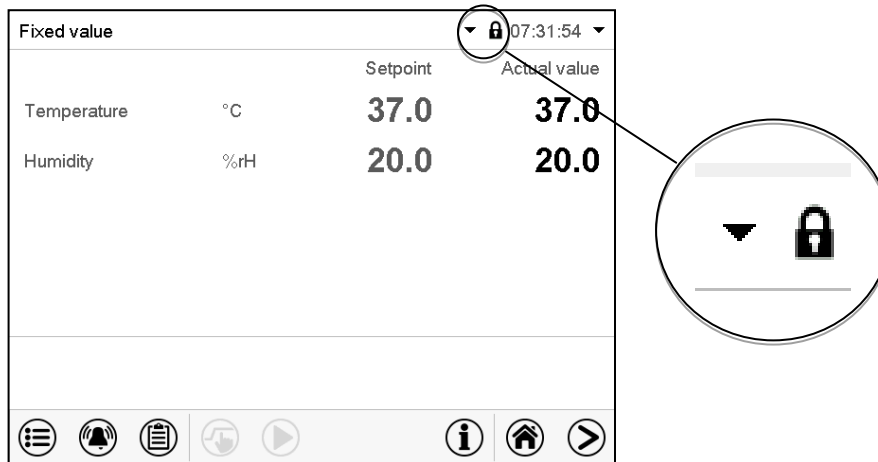

In the locked view the controller provides all display functions. No setting functions are available.

The setpoints are shaded (light grey) in normal display. Changing them by direct entry in the fixed value operating mode is not possible. The functional icons for setpoint entry and program start in the footer are without function.

After turning on the unit, user log-in is required to operate the controller (chap. 13.2)

Operation without user log-in / without password-protection

If the password function has been deactivated, after turning on the unit without user log-in there are those controller functions available, which correspond to the highest authorization level without a password protection. There is no lock icon in the header.

6.3 Turning on/off humidity control

Turning off humidity control is required when operating the chamber without water connection in order to avoid humidity alarms. For further information see chap. 17.

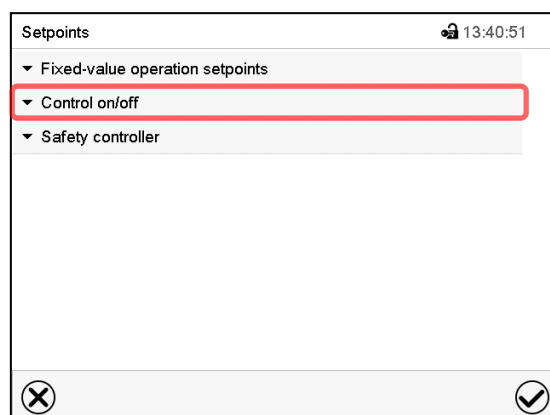
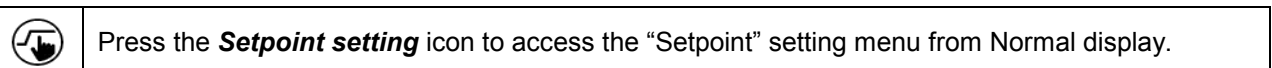

“Setpoints” menu.

Select “Control on/off”.

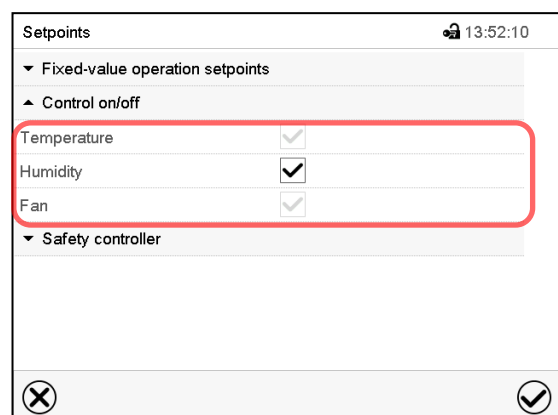

You can turn humidity control (humidification and dehumidification) on or off.

If the “Humidity” checkbox is marked, humidity control is active. Mark / unmark the checkbox to change the setting.

7. Set-point entry in “Fixed value” operating mode

In Fixed value operating mode you can enter a temperature set-point, a humidity set-point, the fan speed, and the switching-state of up to 16 operation lines.

All settings made in Fixed value operating mode remain valid until the next manual change. They are saved also when turning off the chamber or in case of toggling to Idle Mode or Program Mode.

	Setting ranges	Control ranges
Temperature KBF	-5 °C / 41 °F up to 70 °C / 158 °F.	0 °C / 32 °F up to 70 °C / 158 °F without humidity 10 °C / 50 °F up to 70 °C / 158 °F with humidity
Temperature KMF	-15 °C / 5 °F up to 100 °C / 212 °F	-10 °C / 14 °F up to 100 °C / 212 °F without humidity 10 °C / 50 °F up to 90 °C / 194 °F with humidity
Humidity KBF	0 % r.H. up to 80 % r.H.	10 % r.H. to 80 % r.H. see climatic diagrams, chap. 17.
Humidity KMF	0 % r.H. up to 10 % r.H.	0 % r.H. to 98 % r.H. see climatic diagrams, chap. 17.
Fan speed	40% up to 100 %	



Reduce the fan speed only if required, because the spatial distribution of temperature and humidity will also be reduced.

Technical data refers to 100% fan speed.

For the control range of temperature and relative humidity, see the temperature / humidity diagrams chap. 17).



With set-point type “Limit”, adapt the safety controller (chap. 12.2) or the temperature safety device class 3.3 (option, chap.12.3) always when you changed the temperature set-point. Set the safety controller set-point or the set-point of temperature safety device class 3.3 (option) by approx. 2 °C to 5 °C above the controller temperature set-point.

Recommended setting: Set-point type “Offset” with safety controller set-point 2 °C.



When operating without humidity by setting “Control off” (chap. 6.3), the humidity tolerance range function is automatically deactivated.

When operating without humidity by activated operation line “Humidity off” (chap. 7.3), set the humidity tolerance range to “0” in order to avoid tolerance range alarms (chap. 11.4).

7.1 Set-point entry for temperature, humidity, and fan speed through the “Setpoints” menu

	Press the Setpoint setting icon to access the “Setpoint” setting menu from Normal display.
	Press the Back icon to go return to Normal display from any menu.

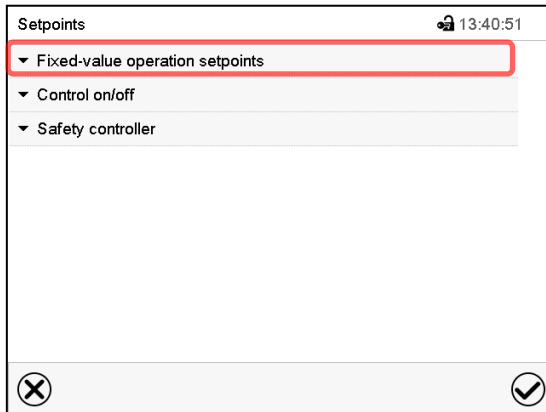

“Setpoints” menu.

Select “Fixed value operation setpoints”.

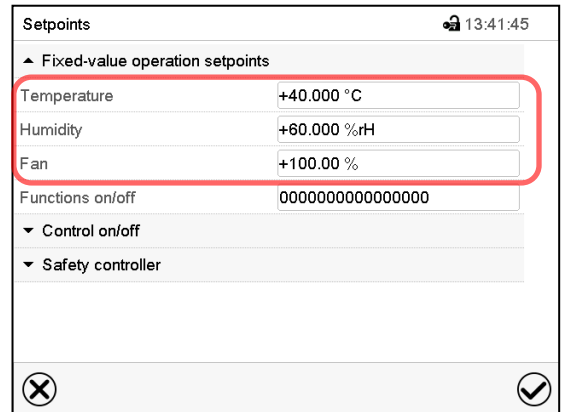

“Setpoints” menu.

Select the parameter to enter the setpoint.

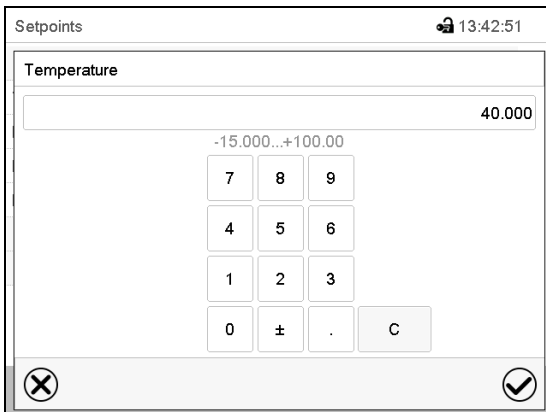

“Temperature” entry menu.

Enter the desired setpoint and press the **Confirm** icon.

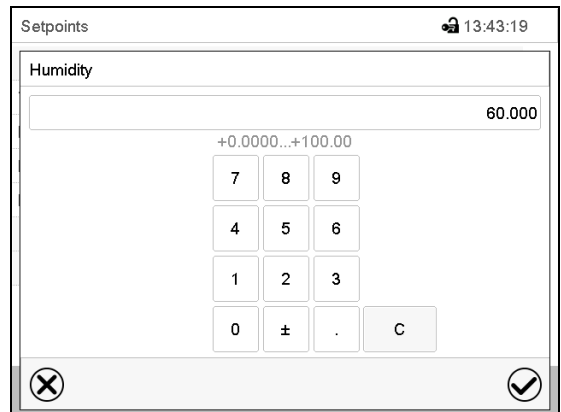

“Humidity” entry menu.

Enter the desired setpoint and press the **Confirm** icon.

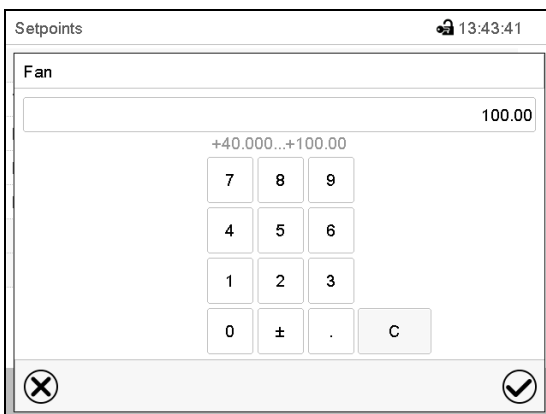

“Fan” entry menu.

Enter the desired setpoint and press the **Confirm** icon.



When entering a value outside the setting range, the message: “Value outside of limits! (Min: xxx, Max: xxx)” appears (xxx is a wildcard for the limits of the respective parameter). Press the **Confirm** icon and repeat the entry with a correct value.

7.2 Direct setpoint entry via Normal display

Alternatively you can also enter the setpoints directly via Normal display.

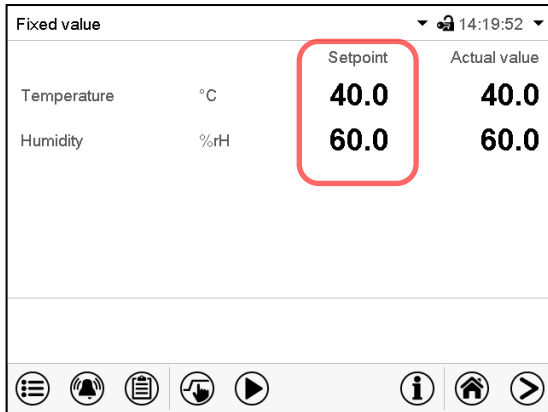

Normal display.

Select the setpoint you want to change.

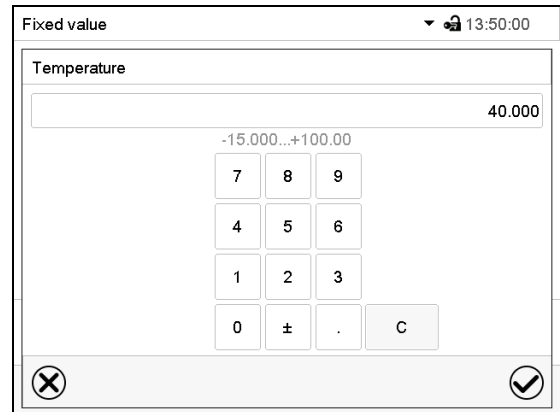

Example: “Temperature” entry menu.

Enter the desired value and press the **Confirm** icon.

7.3 Special controller functions via operation lines

You can define the switching state of up to 16 operation lines (control contacts). They are used to activate / deactivate special controller functions.

- Operation line “Humidity off” serves to turn off the humidity.
- Operation line “Idle mode” activates / deactivates the operating mode “Idle mode”.

The other operation lines are without function.

Use the “Setpoints” menu to configure the operation lines.

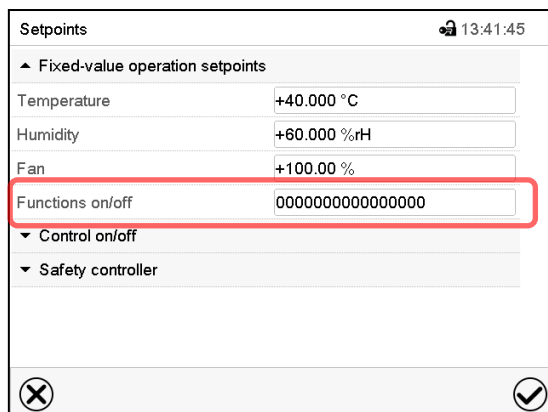

“Setpoints” menu.

Select the field “Functions on/off”.

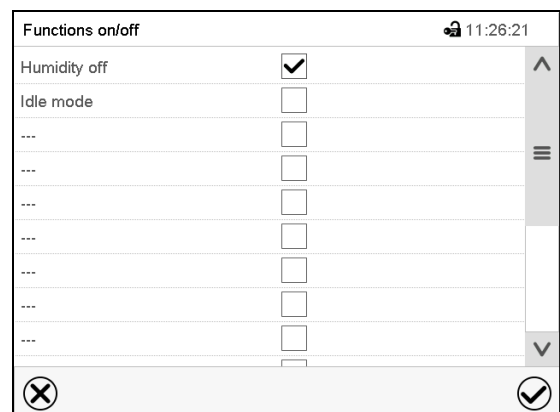

“Functions on/off” entry menu.

Mark / unmark the checkbox to activate / deactivate the desired function.

Activated operation line: switching status “1” (On)

Deactivated operation line: switching status “0” (Off)

The operation lines count from right to left.

Example:

Activated operation line “Humidity off” = 0000000000000001

Deactivated operation line “Humidity off” = 0000000000000000

8. Timer program: stopwatch function

During an entered duration the controller constantly equilibrates to the setpoints entered in Fixed value operation mode (temperature, humidity, fan speed, configuration of the operation lines). This duration can be entered as a “Timer program”. During the program runtime, any setpoint changes do not become effective; the controller equilibrates to the values which were active during program start.

8.1 Starting a timer program

 In Normal display press the **Program start** icon to access the “Program start” menu.

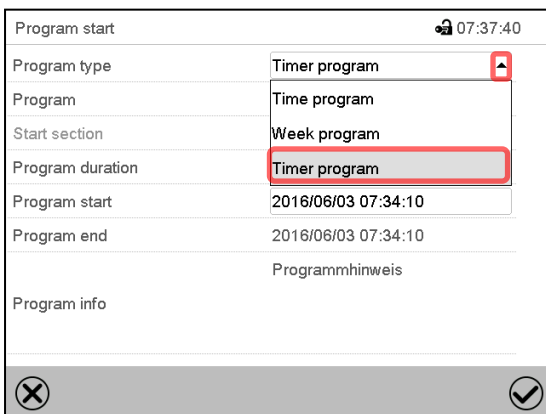

“Program start” menu
In the field “Program type” select “Timer program”.

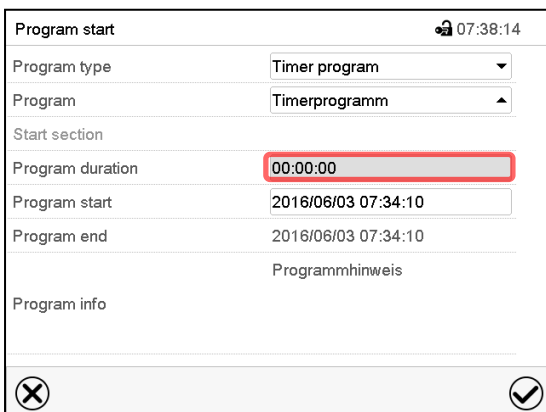

“Program start” menu.
Select the field “Program duration”

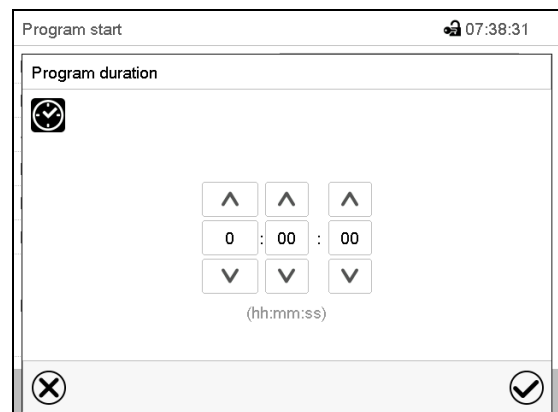

Enter the desired program duration and press the **Confirm** icon.

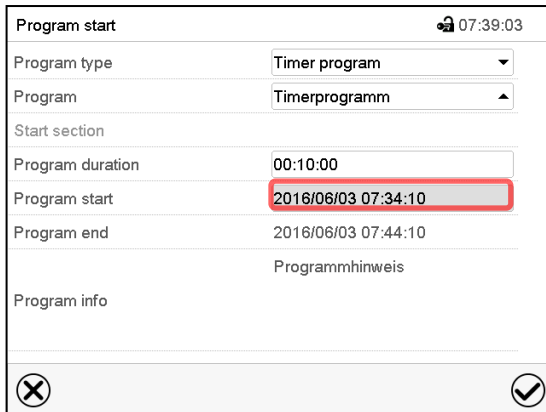

“Program start” menu.

Select the field “Program start”.

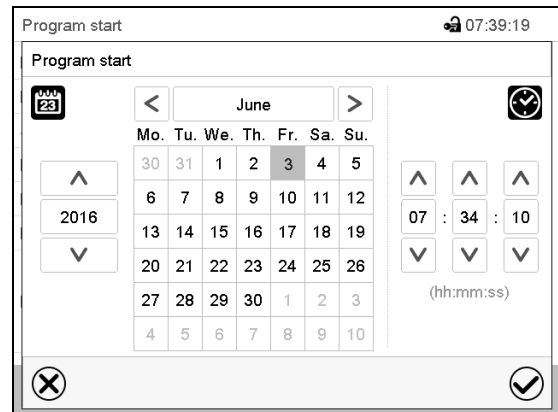

Enter the desired start time of the program and press the **Confirm** icon. The program delay time until program start begins.

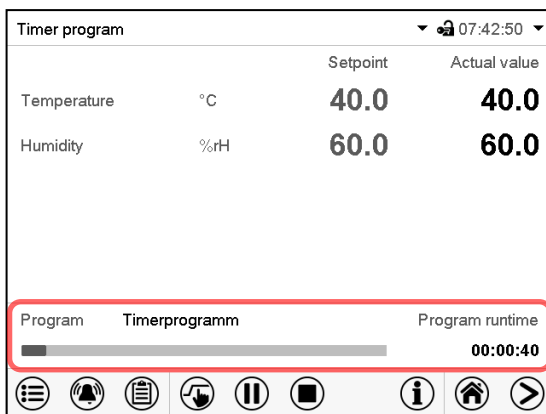

Normal display.

Information on the bottom of the screen indicates the currently running program and the time already passed. The grey bar shows how much time of the whole time is elapsed.

8.1.1 Performance during program delay time

During the configured program delay time until program start, the controller equilibrates to the current setpoints of Fixed value operation mode. Modifications of these setpoints are effective. When the configured moment for program start is reached, the program delay time ends and the program starts running. The controller equilibrates to the values which had been active during program start

8.2 Stopping a running timer program

8.2.1 Pausing a running timer program

	Press the Program pause icon to interrupt the program.
--	---

The program is paused. The program runtime stops running down, the time display flashes.

There are the following options:

	Press the Program start icon to continue the program
	Press the Cancelling icon to cancel the program

8.2.2 Cancelling a running timer program

 Press the **Program cancelling** icon to cancel the program.

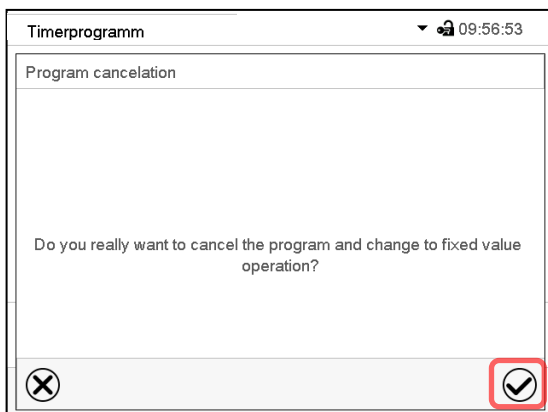

A confirmation prompt is displayed. Press the **Confirm** icon to confirm that the program shall really be cancelled.

After confirming the message the controller changes to Fixed value operation mode. Temperature and humidity will then equilibrate to the setpoints of Fixed value operation mode.

8.3 Performance after the end of the program

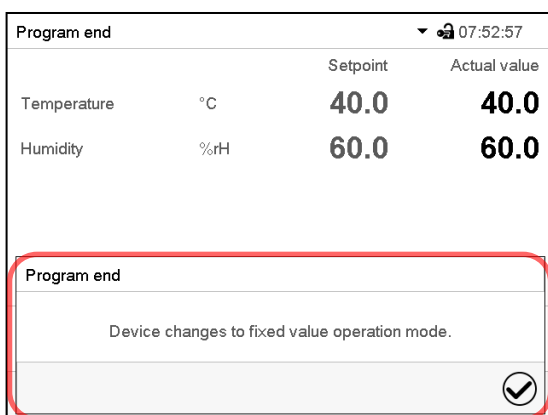

After the end of the program the message “Device changes to fixed value operation mode” appears on the screen.

Press the **Confirm** icon.

After confirming the message the controller changes to Fixed value operation mode. Temperature and humidity will then equilibrate to the setpoints of Fixed value operation mode.

9. Time programs

The MB2 program controller permits programming time programs with real-time reference. It offers 25 program memory positions with up to 100 program sections each.

For each program section you can enter a temperature set-point, fan speed, section duration, type of temperature transition (ramp or step) and the tolerance range.

 If the safety controller has been set to “limit” mode, check the setting of the safety controller when changing the temperature set-point, (chap. 12.2).

 Reduce the fan speed only if required, because the spatial distribution of temperature and humidity will also be reduced.
Technical data refers to 100% fan speed.

Programming remains saved in case of a power failure or after turning off the unit.

Path: **Main menu > Programs > Time program**

9.1 Starting an existing time program

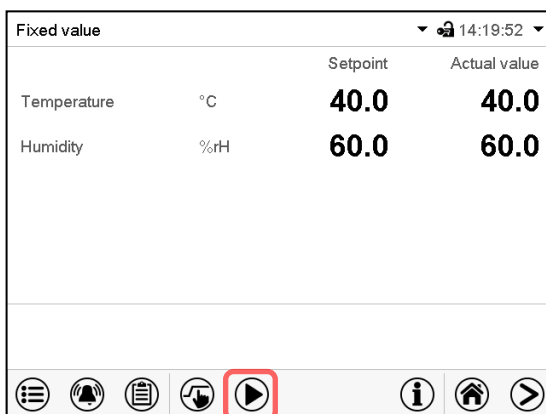

Normal display.

Press the **Program start** icon.

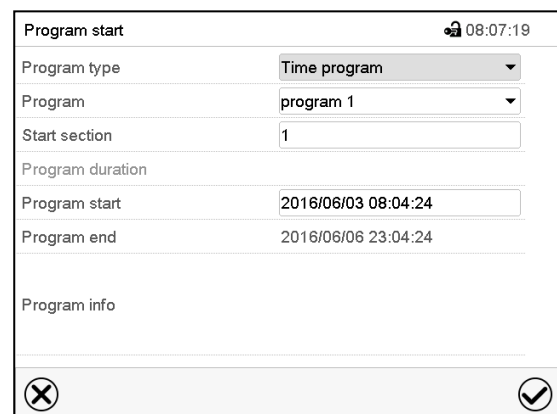

“Program start” menu

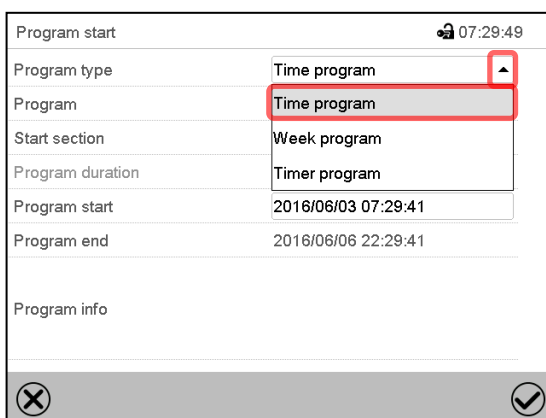

“Program start” menu.

In the field “Program type” select the setting “Time program”.

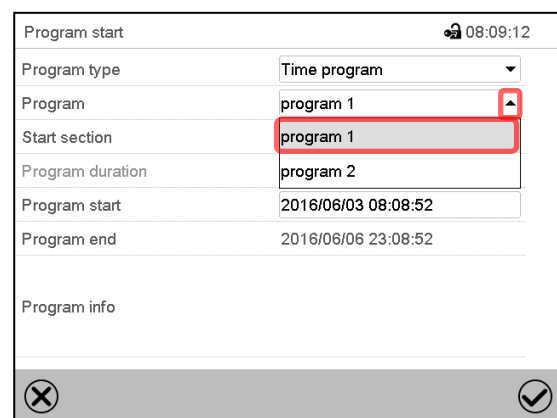

“Program start” menu.

In the field “Program” select the desired program.

Program start 07:32:22

Program type Time program

Program program 1

Start section 1

Program duration

Program start 2016/06/03 07:32:11

Program end 2016/06/06 22:32:11

Program info

⊗ ⊕

“Program start” menu.

Select the field “Program start”.



Program start 07:32:39

Program start

June

Mo.	Tu.	We.	Th.	Fr.	Sa.	Su.
30	31	1	2	3	4	5
6	7	8	9	10	11	12
13	14	15	16	17	18	19
20	21	22	23	24	25	26
27	28	29	30	1	2	3
4	5	6	7	8	9	10

2016

07 : 32 : 11

(hh:mm:ss)

⊗ ⊕

“Program start” menu.

Enter the desired program start time and press the **Confirm** icon. The program delay time until program start begins.

The program end is adapted automatically depending on the entered program duration.

Program start 08:07:19

Program type Time program

Program program 1

Start section 1

Program duration

Program start 2016/06/03 08:04:24

Program end 2016/06/06 23:04:24

Program info

⊗ ⊕

When all settings have been completed, press the **Confirm** icon.



Time program 08:26:25

	Setpoint	Actual value
Temperature °C	10.0	10.0
Humidity %rH	40.0	40.0

Program program 1 Program runtime 00:01:23

⊗ ⊕

Normal display.

Information on the bottom of the screen indicates the currently running program and the time already passed. The grey bar shows how much time of the whole time is elapsed. If program duration has been set to infinite, the grey bar is not displayed.

9.1.1 Performance during program delay time

During the configured program delay time until program start, the controller equilibrates to the current setpoints of Fixed value operation mode. Modifications of these setpoints are effective. When the configured moment for program start is reached, the program delay time ends and the program starts running.



9.2 Stopping a running time program

9.2.1 Pausing a running time program

	Press the Program pause icon to interrupt the program..
---	--

The program is paused. The program runtime stops running down, the time display flashes.

There are the following options:

	Press the Program start icon to continue the program
	Press the Cancelling icon to cancel the program

9.2.2 Cancelling a running time program

	Press the Program cancelling icon to cancel the program.
---	---

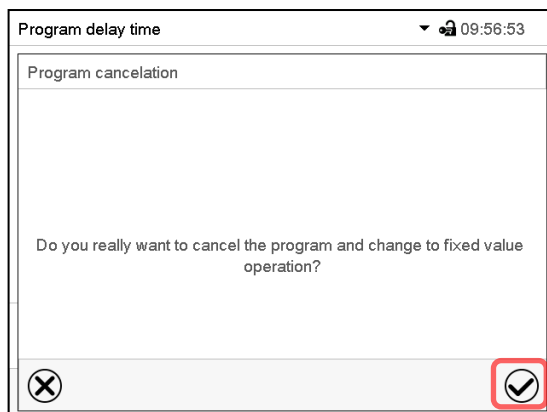

A confirmation prompt is displayed. Press the **Confirm** icon to confirm that the program shall really be cancelled.

After confirming the message, the controller changes to Fixed value operation mode. Temperature and humidity will then equilibrate to the setpoints of Fixed value operation mode.

9.3 Performance after the end of the program

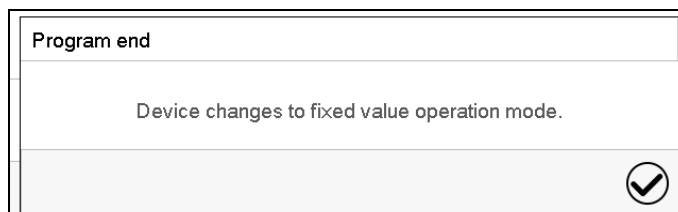

After the end of the program the message "Device changes to fixed value operation mode" appears on the screen.

Press the **Confirm** icon.

As long as the message has not been confirmed, the setpoint of the last program section remains effective. Program the last section as desired. If e.g. heating, refrigeration, humidification and dehumidification shall turn off, activate operation line "Idle mode" in the last program section.

After confirming the message the controller changes to Fixed value operation mode. Temperature and humidity will then equilibrate to the setpoints of Fixed value operation mode.

9.4 Creating a new time program

Path: **Main menu > Programs > Time program**

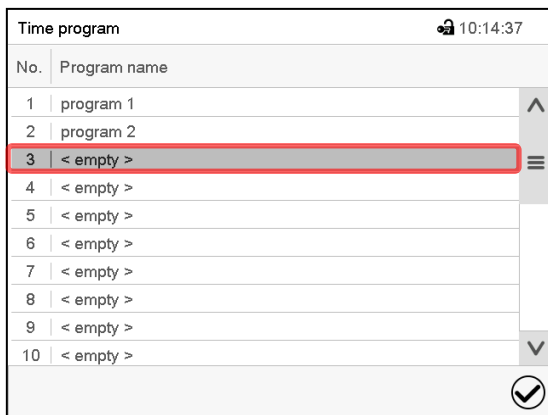

“Time program” menu:
overview of the existing programs.
Select an empty program place.

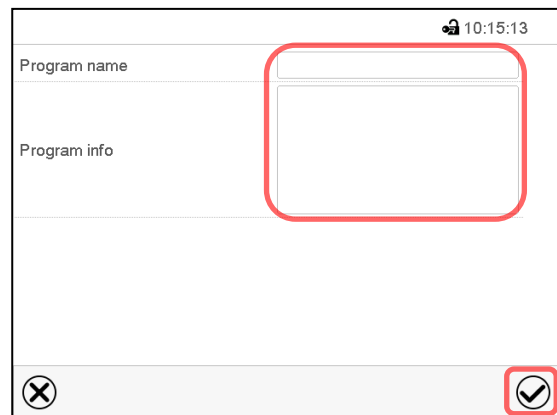

Enter the program name and, if desired, additional program information in the corresponding fields.

Press the **Confirm** icon.

The program view opens (chap. 9.5).

9.5 Program editor: program management

Path: **Main menu > Programs > Time program**

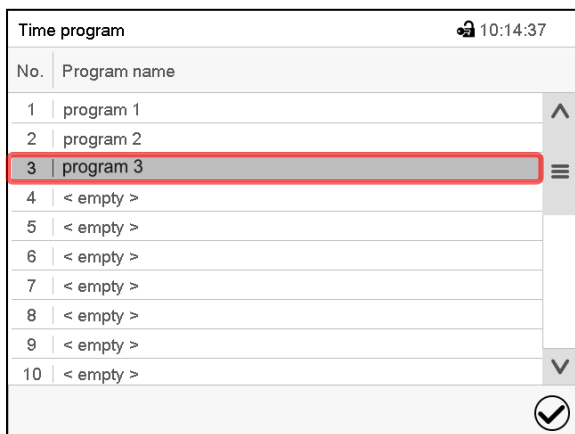

“Time program” menu:
overview of the existing programs.

Select an existing program (example: program 3) or create a new program (chap. 9.4).

The program view opens.

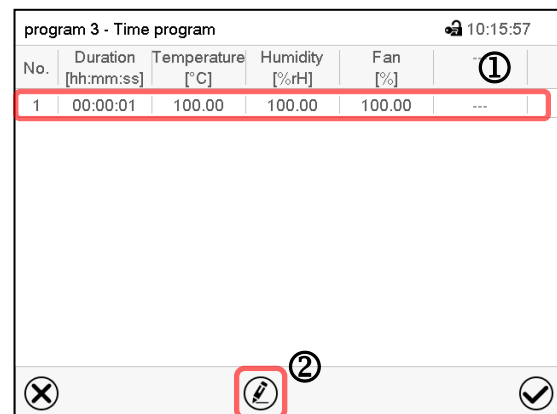

Program view (example: program 3).

If a new program has been created, there is just one program section.

There are the following options:

- ① Select a program section to open the section editor (chap. 9.6)
- ② Press the **Edit** icon to open the program editor



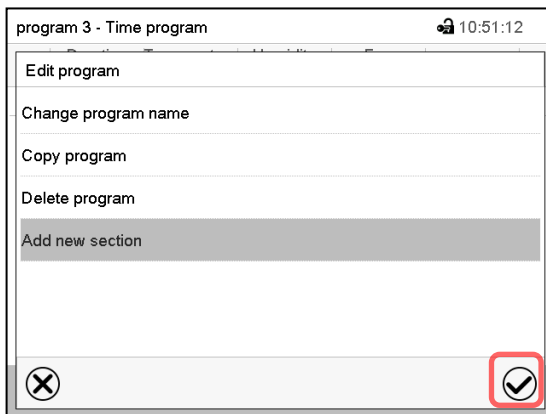

Program editor: "Edit program" menu

Select the desired function and press the **Confirm** icon.

The program editor offers following options:

- Change the program name
- Copy program
- Replace program: Replacing an new or an existing program with the copied program. This menu point is visible only after a program has been copied.
- Delete program
- Add new section

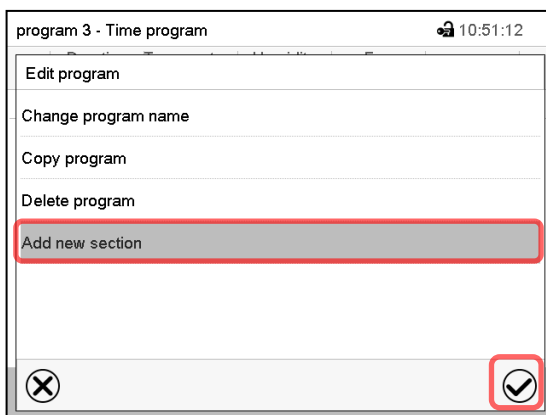

To add a new section, select "Add new section" and press the **Confirm** icon.

The program view opens.

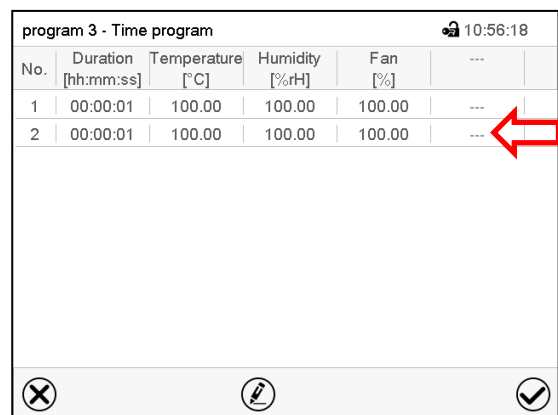
No.	Duration [hh:mm:ss]	Temperature [°C]	Humidity [%rH]	Fan [%]	...
1	00:00:01	100.00	100.00	100.00	...
2	00:00:01	100.00	100.00	100.00	...

Program view.

A new section is always added at the very bottom (example: section 2).

9.6 Section editor: Section management

Path: **Main menu > Programs > Time program**

Select the desired program.

No.	Duration [hh:mm:ss]	Temperature [°C]	Humidity [%rH]	Fan [%]	...
1	00:00:01	100.00	100.00	100.00	---
2	00:00:01	100.00	100.00	100.00	---

Program view.

Select the desired program section (example: section 1)



Duration: 00:00:01

Course: Ramp

Functions on/off: 0000000000000000

Number of repetitions: 0

Start section for repetition: 1

Temperature: +100.00

Tolerance band min.: +0.0000

Tolerance band max.: +0.0000

Humidity: +100.00

Section view (example: section 1).

There are the following options:

- ① Select a parameter to enter or modify the according value (chap. 9.7)
- ② Press the **Edit** icon to open the program editor



Section editor: "Edit section" menu

- Edit section
- Copy section
- Delete section
- Add new section

Section editor: "Edit section" menu

Select the desired function and press the **Confirm** icon.

The section editor offers following options:

- Copy section
- Replace section: Replacing an existing section with the copied section. This menu point is visible only after a section has been copied.
- Insert section: Adding the copied section. This menu point is visible only after a section has been copied.
- Delete section
- Add new section

9.6.1 Add a new section

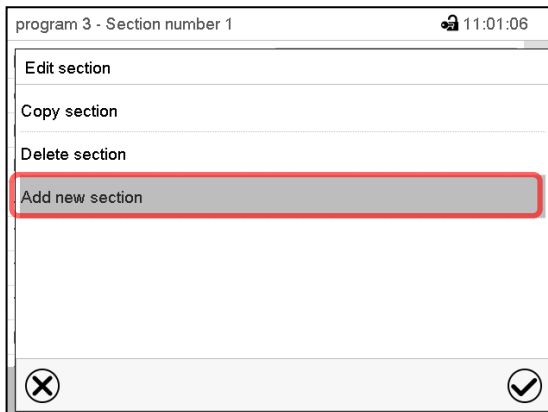

Section editor: "Edit section" menu.

Select "Add new section" and press the **Confirm** icon.

Then select whether to insert the new section before or after the current section.

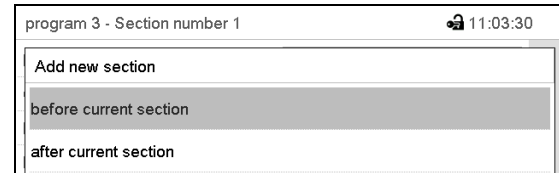

Press the **Confirm** icon. The new section opens.

9.6.2 Copy and insert or replace a section

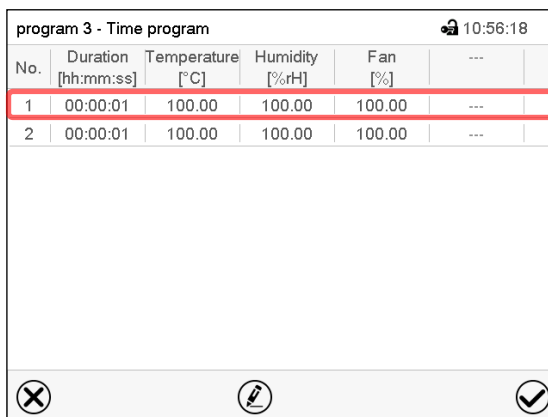

Program view.

Select the program section to be copied (example: section 1)

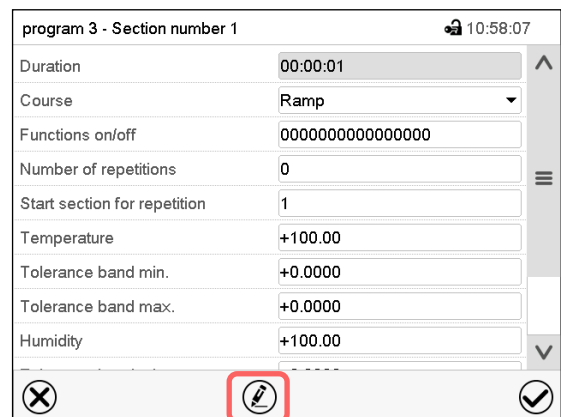

Section view (example: section 1).

Press the **Edit** icon to open the section editor.

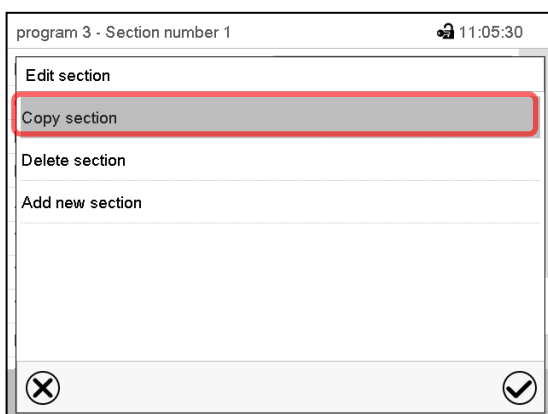

Section editor: "Edit section" menu

Select "Copy section" and press the **Confirm** icon.

The current section (example: section 1) is copied.

The controller returns to the section view.

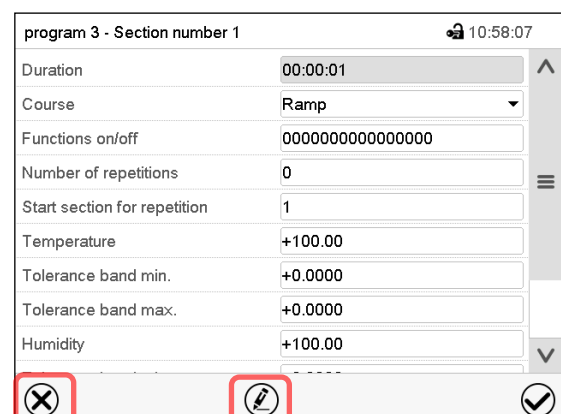

Section view (example: section 1).

Press the **Close** icon to change to the program view, if you want to select another section to be replaced or before or after which the copied section shall be inserted

or

Press the **Edit** icon to open the section editor if you want the current section to be replaced or the copied section to be inserted before or after it

program 3 - Time program 10:56:18

No.	Duration [hh:mm:ss]	Temperature [°C]	Humidity [%rH]	Fan [%]	...
1	00:00:01	100.00	100.00	100.00	---
2	00:00:01	100.00	100.00	100.00	---

⊗ ⚙️ ✓

Program view.

Select the section to be replaced or before or after which the copied section shall be inserted (example: section 2) and press the **Confirm** icon.



program 3 - Section number 1 10:58:07

Duration 00:00:01

Course Ramp

Functions on/off 0000000000000000

Number of repetitions 0

Start section for repetition 1

Temperature +100.00

Tolerance band min. +0.0000

Tolerance band max. +0.0000

Humidity +100.00

⊗ **⚙️** ✓

Section view (example: section 1).

Press the **Edit** icon to open the section editor



program 3 - Section number 2 11:09:20

Edit section

Copy section

Replace section

Insert section

Delete section

Add new section

⊗ ✓

Section editor: "Edit section" menu

Select "Replace section" to replace the selected section with the copied section

or

Select "Insert section" to additionally add the copied section.

In this case select whether to insert it before or after the selected section.

Insert section

before current section

after current section

Press the **Confirm** icon

9.6.3 Deleting a section

In the **program view** select the program section to be deleted. The section view opens.



In the **section view** press the **Edit** icon to open the section editor



In the **section editor** select "Delete section" and press the **Confirm** icon.

The section is deleted. The controller returns to the section view.

9.7 Value entry for a program section

Path: **Main menu > Programs > Time program**

Select the desired program and section.

The section view gives access to all parameters of a program section. You can enter or modify the values.

<p>program 3 - Section number 1 🔒 10:58:07</p> <p>Duration <input type="text" value="00:00:01"/> ^</p> <p>Course <input type="text" value="Ramp"/> v</p> <p>Functions on/off <input type="text" value="0000000000000000"/></p> <p>Number of repetitions <input type="text" value="0"/> ≡</p> <p>Start section for repetition <input type="text" value="1"/></p> <p>Temperature <input type="text" value="+100.00"/></p> <hr/> <p>Tolerance band min. <input type="text" value="+0.0000"/></p> <p>Tolerance band max. <input type="text" value="+0.0000"/></p> <p>Humidity <input type="text" value="+70.000"/> ≡</p> <p>Tolerance band min. <input type="text" value="+0.0000"/></p> <p>Tolerance band max. <input type="text" value="+0.0000"/></p> <p>Fan <input type="text" value="+100.00"/> v</p> <p style="text-align: center;">⊗ ✎ ✓</p>	<table border="1"> <tr><th colspan="2">Program name and section number</th></tr> <tr><td>Section duration</td><td></td></tr> <tr><td>Type of setpoint transition: ramp or step</td><td></td></tr> <tr><td>Operation lines</td><td></td></tr> <tr><td colspan="2">Repeating one or several sections within a program</td></tr> <tr><td>Temperature setpoint</td><td></td></tr> <tr><td colspan="2">Temperature tolerance range: minimum and maximum</td></tr> <tr><td>Humidity setpoint</td><td></td></tr> <tr><td colspan="2">Humidity tolerance range: minimum and maximum</td></tr> <tr><td>Fan speed</td><td></td></tr> <tr><td colspan="2"> </td></tr> </table>	Program name and section number		Section duration		Type of setpoint transition: ramp or step		Operation lines		Repeating one or several sections within a program		Temperature setpoint		Temperature tolerance range: minimum and maximum		Humidity setpoint		Humidity tolerance range: minimum and maximum		Fan speed			
Program name and section number																							
Section duration																							
Type of setpoint transition: ramp or step																							
Operation lines																							
Repeating one or several sections within a program																							
Temperature setpoint																							
Temperature tolerance range: minimum and maximum																							
Humidity setpoint																							
Humidity tolerance range: minimum and maximum																							
Fan speed																							

The setting and control ranges for the individual parameters are the same as for “Fixed value” operating mode (chap. 7).

9.7.1 Section duration

program 3 - Section number 1 🔒 10:58:07

Duration ^

Section view (partial view).

Select the field “Duration” indicating the time.

program 3 - Section number 2 🔒 11:14:19

Duration

☑

: :

 (hh:mm:ss)

⊗ ✓

“Duration” entry menu.

Enter the desired section duration with the arrow keys and press the **Confirm** icon.

Setting range: 0 up to 99 hours 59 min 59 sec.

9.7.2 Set-point ramp and set-point step

You can define the type of temperature and humidity transitions for each individual program section.

“Ramp” mode: Gradual changes of temperature and humidity

The set-point of a given program section functions as the section’s start temperature. During the section’s duration, the set-point gradually passes to the set-point of the subsequent program section. The actual value follows the continually changing set-point.

If the last program section is in “ramp” mode and the setpoint shall change within this section, then you must program an additional section (with the shortest possible section duration) to provide the target temperature of the last program section. Otherwise, the setpoint would remain constant during the section’s duration.

Programming in the “ramp” mode allows all kinds of temperature and humidity transitions:

- Gradual changes of temperature and humidity
The setpoint changes its value gradually during the entered section duration. The actual value follows the continually moving set-point at any time.
- Program sections with constant temperature and humidity
The setpoints (initial values) of two subsequent program sections are identical; so the temperature and humidity remain constant during the entire duration of the first program section.
- Sudden changes of temperature and humidity
Steps can be programmed in ramp mode as temperature or humidity changes (ramps) that occur during a very short interval. If the duration of this transitional program section is very short (minimum entry 1 sec), the temperature or humidity change will proceed rapidly within the minimum amount of time.

“Step” mode: Sudden changes of temperature and humidity

The set-point of any program section functions as the section’s target value. At the start of the program section, the unit heats up or cools down and humidifies/dehumidifies the chamber with the maximum speed to reach the entered value; and then it holds it for the remaining section time. Therefore the set-point temperature remains constant for the section’s duration. These changes occur rapidly within the minimum amount of time (minimum entry: 1 second).

Programming in the “step” mode allows only two kinds of temperature and humidity transitions:

- Programming gradual changes of temperature and humidity (ramps) is impossible in the “step” mode
- Program sections with constant temperature and humidity
The setpoints (target values) of two subsequent program sections are identical; so the temperature and humidity remain constant during the entire duration of the first program section.
- Sudden changes of temperature and humidity
The entered setpoint of the section is reached as fast as possible and then held constant for the remaining section duration.

Selecting the setting “Ramp” or “Step”

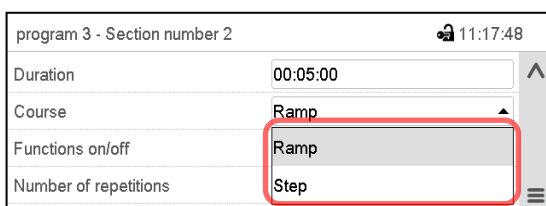

The screenshot shows a control interface for 'program 3 - Section number 2' at 11:17:48. It features a table with the following fields: 'Duration' (00:05:00), 'Course' (Ramp), 'Functions on/off' (Ramp), and 'Number of repetitions' (Step). A red box highlights the 'Course' dropdown menu, which is currently set to 'Ramp' and has 'Step' as an alternative option.

Section view (partial view).

In the field “Course” select the desired setting “Ramp” or “Step”.

“Ramp” and “Step” mode example (representation of a temperature course)

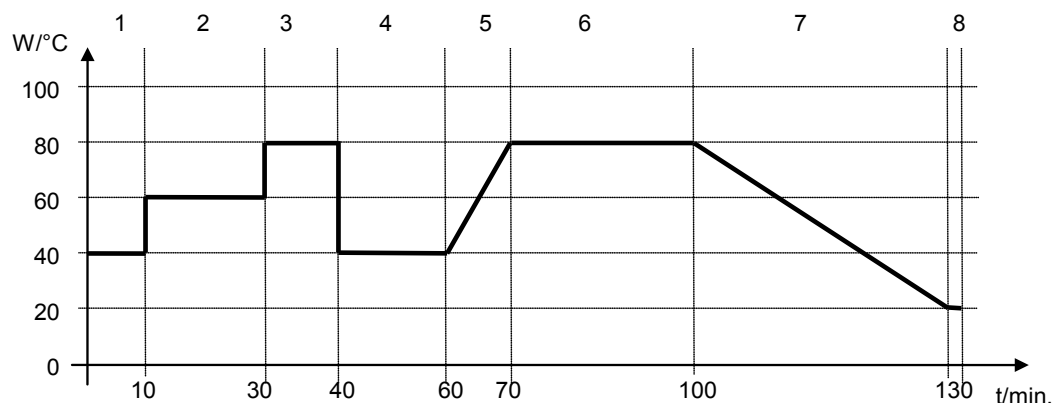

Corresponding program table

Section No.	Duration [hh:mm:ss]	Temperature [°C]	Humidity [% rH]	Fan [%]	Ramp or Step
1	00:10:00	40.0	xxxx	xxxx	Step
2	00:20:00	60.0	xxxx	xxxx	Step
3	00:10:00	80.0	xxxx	xxxx	Step
4	00:20:00	40.0	xxxx	xxxx	Step
5	00:10:00	40.0	xxxx	xxxx	Ramp
6	00:30:00	80.0	xxxx	xxxx	Ramp
7	00:30:00	80.0	xxxx	xxxx	Ramp
8	00:00:01	20.0	xxxx	xxxx	Ramp

9.7.3 Special controller functions via operation lines

You can define the switching state of up to 16 operation lines (control contacts). They are used to activate / deactivate special controller functions.

- Operation line “Humidity off” serves to turn off the humidity.
- Operation line “Idle mode” activates / deactivates the operating mode “Idle mode”.

The other operation lines are without function.

Use the Section editor to configure the operation lines.

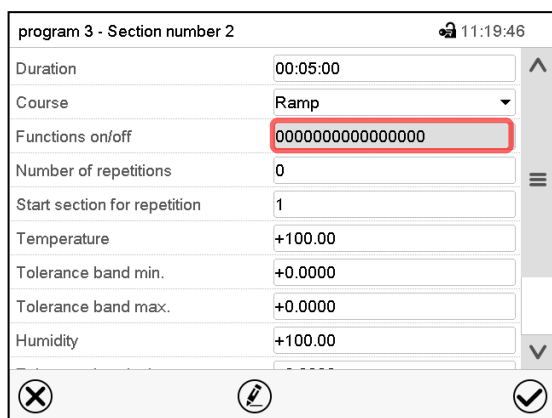

Section view.

Select the field “Functions on/off”.

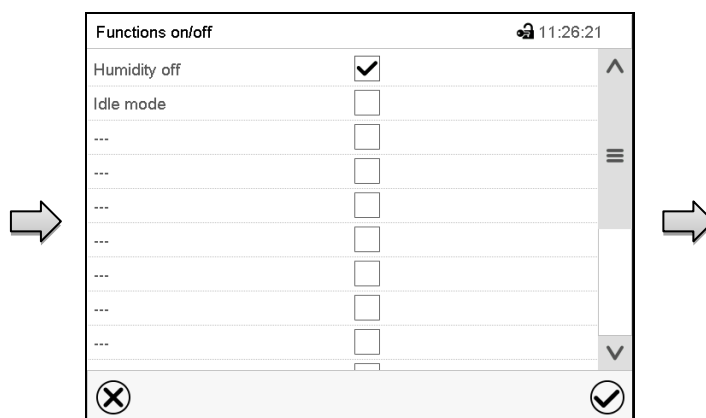

“Functions on/off” entry menu.

Mark / unmark the checkbox of the desired function to activate / deactivate it and press the **Confirm** icon.

The controller returns to the section view.

program 3 - Section number 2 11:27:18

Duration 00:05:00

Course Ramp

Functions on/off 0000000000000001

Number of repetitions 0

Start section for repetition 1

Temperature +100.00

Tolerance band min. +0.0000

Tolerance band max. +0.0000

Humidity +100.00

Section view indicating the operation lines.

Activated operation line: switching status "1" (On)

Deactivated operation line: switching status "0" (Off)

The operation lines count from right to left.

Example:

Activated operation line "Humidity off" = 0000000000000001

Deactivated operation line "Humidity off" = 0000000000000000

9.7.4 Temperature setpoint

program 3 - Section number 2 11:27:18

Duration 00:05:00

Course Ramp

Functions on/off 0000000000000001

Number of repetitions 0

Start section for repetition 1

Temperature +100.00

Tolerance band min. +0.0000

Tolerance band max. +0.0000

Humidity +100.00

Section view.

Select the field "Temperature".



program 3 - Section number 2 11:34:23

Temperature

100.00

-15.000...+100.00

7 8 9

4 5 6

1 2 3

0 ± . C

"Temperature" entry menu.

Enter the desired temperature and press the **Confirm** icon.

Setting range:

KBF: -5 °C up to 70 °C, KMF: -15 °C up to 100 °C.

The controller returns to the section view.

9.7.5 Humidity setpoint

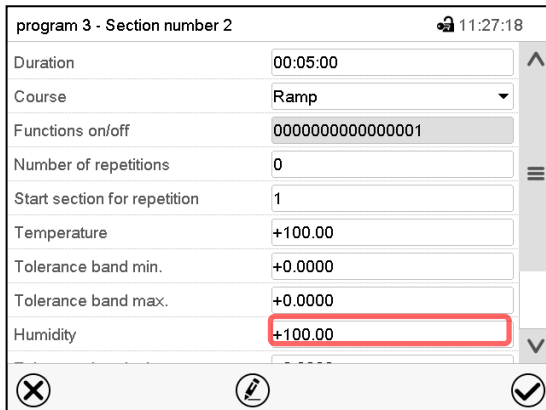

Section view.

Select the field "Humidity".

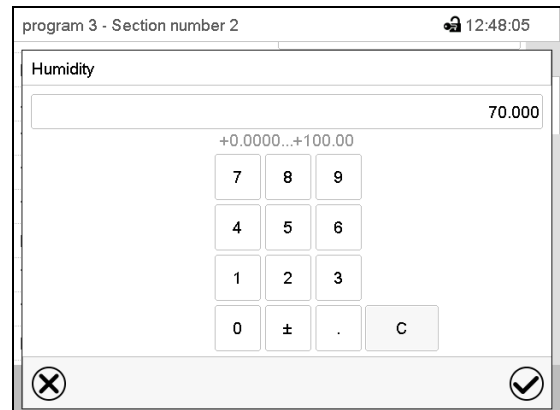

"Humidity" entry menu.

Enter the desired value and press the **Confirm** icon.

Setting range:

KBF: 0% r.H. up to 80% r.H.,

KMF: 0% r.H. up to 100% r.H.

The controller returns to the section view.

9.7.6 Tolerance range

You can specify a temperature and humidity program tolerance range for each program section with different values for the tolerance minimum and maximum. When the actual value exceeds the given threshold, the program is interrupted. This is indicated on the display (see below). When the actual temperature is situated again within the entered tolerance limits, the program automatically continues. Therefore, the duration of the program may be extended due to the programming of tolerances.

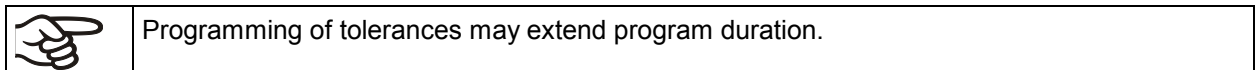

An entry of "-99999" for the tolerance minimum means "minus infinite" and an entry of "999999" for the tolerance maximum means "plus infinite". Entry of these values will never lead to program interruption. The entry of "0" for the tolerance minimum and/or maximum deactivates the respective tolerance function.

When requesting rapid value transitions, we recommend not programming tolerance values in order to enable the maximum heating-up, cooling-down, humidification or dehumidification speed.

program 3 - Section number 2 11:27:18

Duration 00:05:00

Course Ramp

Functions on/off 0000000000000001

Number of repetitions 0

Start section for repetition 1

Temperature +100.00

Tolerance band min. +0.0000

Tolerance band max. +0.0000

Humidity +100.00

Section view.

Select the field "Tolerance band min" to enter the lower tolerance band value.



program 3 - Section number 2 12:52:38

Tolerance band min. 0.0000

-99999...+99999

7 8 9

4 5 6

1 2 3

0 ± . C

"Tolerance band min" entry menu.

Enter the desired value and press the **Confirm** icon.

Setting range: -99999 to 99999

The controller returns to the section view.

program 3 - Section number 2 11:27:18

Duration 00:05:00

Course Ramp

Functions on/off 0000000000000001

Number of repetitions 0

Start section for repetition 1

Temperature +100.00

Tolerance band min. +0.0000

Tolerance band max. +0.0000

Humidity +100.00

Section view.

Select the field "Tolerance band max" to enter the upper tolerance band value.



program 3 - Section number 2 12:54:43

Tolerance band max. 0.0000

-99999...+99999

7 8 9

4 5 6

1 2 3

0 ± . C

"Tolerance band max" entry menu.

Enter the desired value and press the **Confirm** icon.

Setting range: -99999 to 99999

The controller returns to the section view.

If one of the actual values (temperature and/or humidity) is outside the program tolerance range the whole program course is interrupted. During this program interruption time the controller equilibrates to the set-points of the current section.

The screen header indicates "Program pause (tolerance band)". The program runtime indication flashes and does not proceed any further.

When the temperature or humidity values are back within the entered program tolerance range, the program continues automatically.

9.7.7 Fan speed

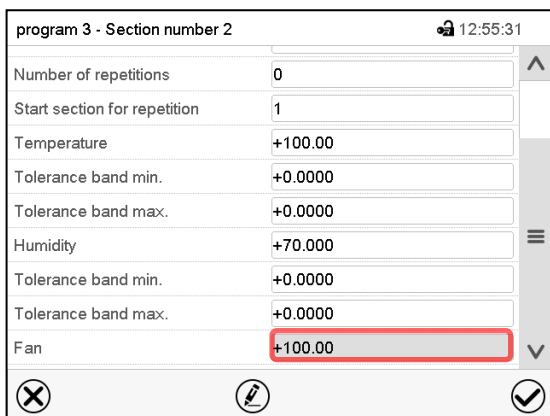

Section view.

Select the field "Fan".

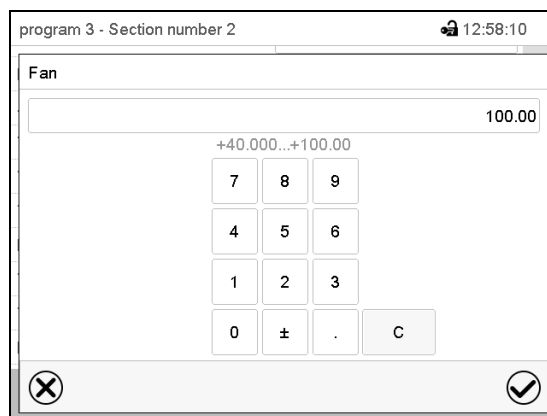

"Fan" entry menu.

Enter the desired value and press the **Confirm** icon.

Setting range: 40% up to 100% fan speed.

The controller returns to the section view.

9.7.8 Repeating one or several sections within a time program

You can repeat individual sections or several subsequent sections together.

Enter the desired number of repetitions in the field „Number of repetitions“ and the number of the section to start the repetition cycle with in the field "Start section for repetition" To have sections repeated infinitely, enter the number of repetitions as "-1".

The selected sections are repeated as many times as selected. Then the program continues.

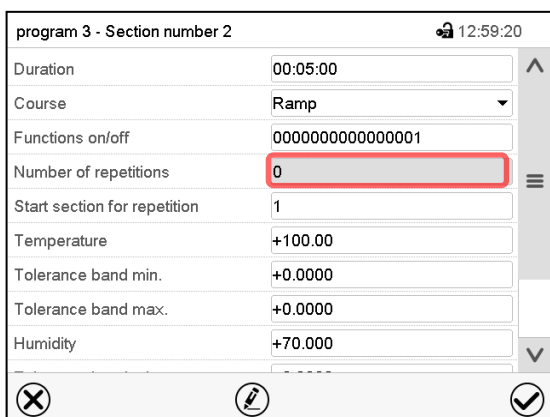

Section view.

Select the field "Number of repetitions".

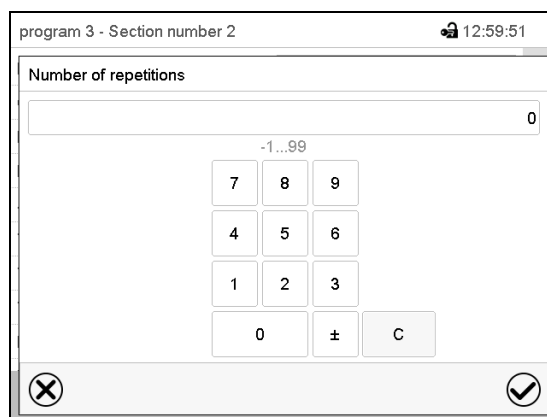

Entry menu "Number of repetitions".

Enter the desired number of repetitions and press the **Confirm** icon.

Setting range: 1 to 99, and -1 for infinite.

The controller returns to the section view.

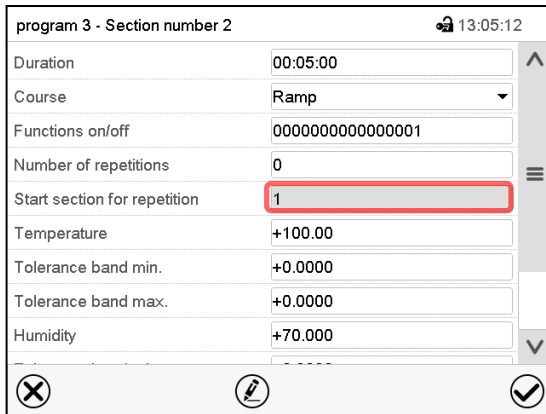

Section view.

Select the field "Start section for repetition".

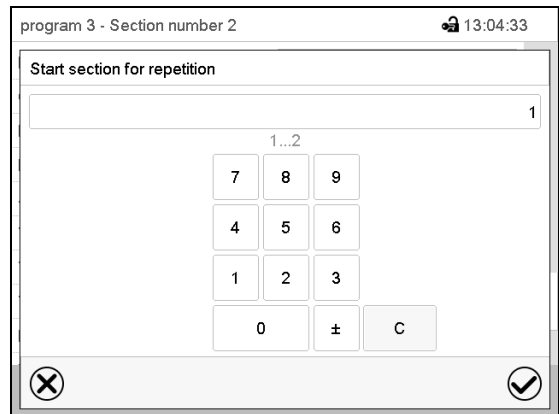

Entry menu „Start section for repetition“.

Enter the section number, at which the repetition should start and press the **Confirm** icon.

Setting range: 1 up to the current selected section

The controller returns to the section view.

9.7.9 Saving the time program

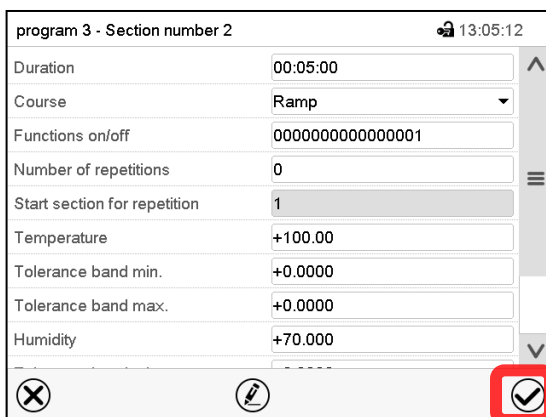

Section view.

After the all desired values of the program section have been configured, press the **Confirm** icon to take over the programming.

The controller changes to the program view.

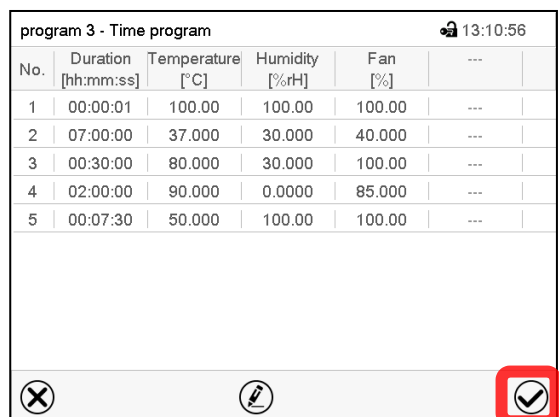

Program view.

Press the **Confirm** icon to take over the programming.

The controller changes to the Normal display.



To save the programming it is absolutely required to press the **Confirm** icon. Otherwise all settings will be lost! There is no confirmation prompt!

10. Week programs

The MB2 program controller permits programming week programs with real-time reference. It offers 5 week program places in total with up to 100 shift points for each week program.

Path: **Main menu > Programs > Week program**

10.1 Starting an existing week program

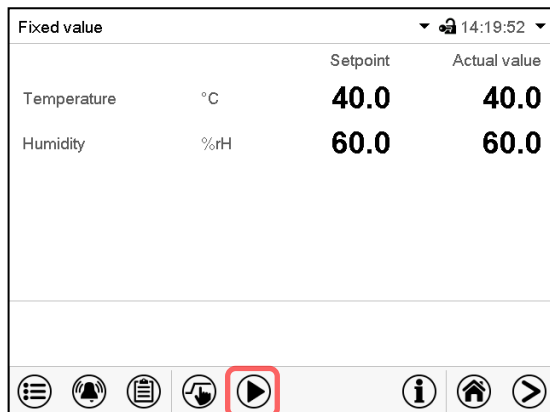

Normal display.

Press the **Program start** icon.

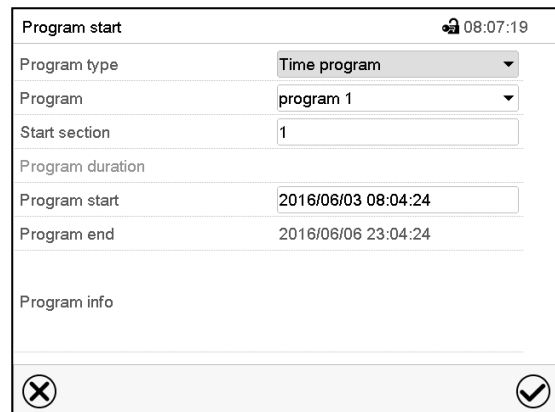

“Program start” menu

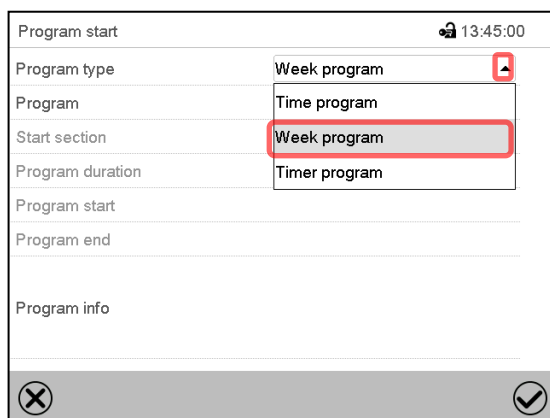

“Program start” menu.

In the field “Program type” select the setting “Week program”.

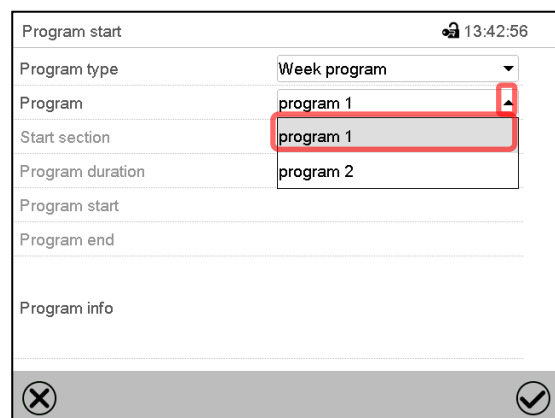



“Program start” menu.

In the field “Program” select the desired program.

There are no further settings available in the “Program start” menu for week programs, as they are needed only for time programs.

There are the following possibilities:

-  Press the **Confirm** icon to take over the entries and exit the menu. The program starts running.
-  Press the **Close** icon to exit the menu without taking over the entries. The program will not start.

After starting the week program, the previously entered week program setpoints are active and will be equilibrated according to the current time.

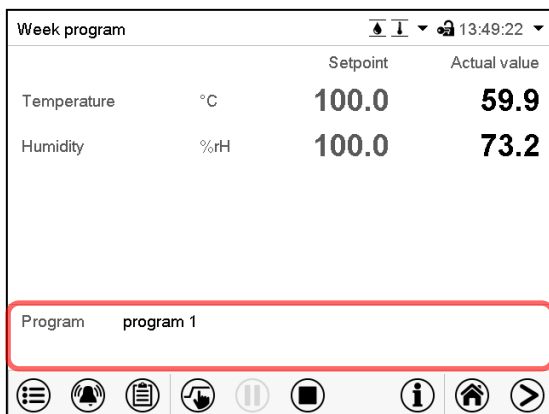

Information on the bottom of the screen indicates the currently running program.

10.2 Cancelling a running week program

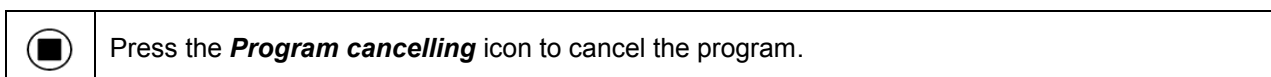

Normal display (partial view).

Press the **Program cancelling** icon to cancel the program.

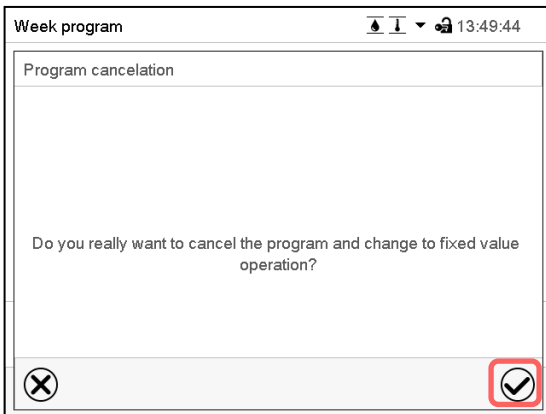

A confirmation prompt is displayed. Press the **Confirm** icon to confirm that the program shall really be cancelled.

After confirming the message the controller changes to Fixed value operation mode. Temperature and humidity will then equilibrate to the setpoints of Fixed value operation mode.

10.3 Creating a new week program

Path: **Main menu > Programs > Week program**

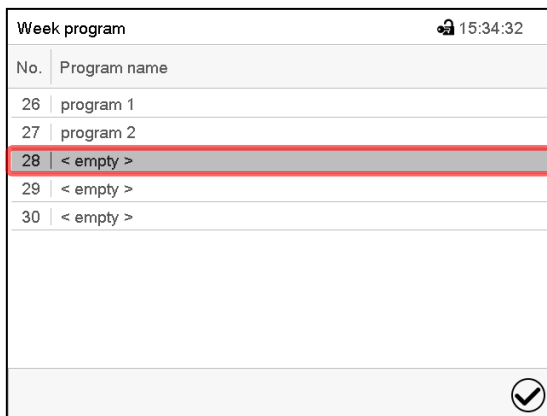

No.	Program name
26	program 1
27	program 2
28	< empty >
29	< empty >
30	< empty >

“Week program” menu:
overview of the existing programs.
Select an empty program place.

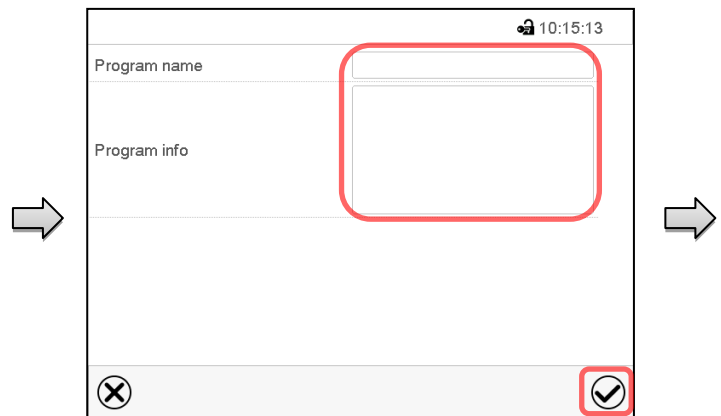

Program name

Program info

Enter the program name and, if desired, additional program information in the corresponding fields.

Press the **Confirm** icon.

The program view opens.

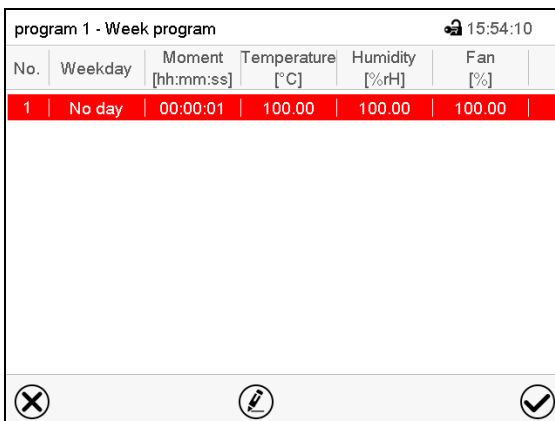

No.	Weekday	Moment [hh:mm:ss]	Temperature [°C]	Humidity [%rH]	Fan [%]
1	No day	00:00:01	100.00	100.00	100.00

Program view.

For the first section no weekday is specified. Therefore the section is first marked in red and cannot be saved.

10.4 Program editor: program management

Path: **Main menu > Programs > Week program**

No.	Program name
26	program 1
27	program 2
28	< empty >
29	< empty >
30	< empty >

“Week program” menu:
overview of the existing programs.

Select an existing program (example: program 1).



No.	Weekday	Moment [hh:mm:ss]	Temperature [°C]	Humidity [%rH]	Fan [%]
1	Monday	00:00:01	100.00	100.00	100.00
2	Tuesday	00:00:01	100.00	100.00	100.00

Program view (example: program 1).

If a new program has been created, there is just one program section.

There are the following options:

- ① Select a program section to open the section editor (chap. 10.5)
- ② Press the **Edit** icon to open the program editor



program 1 - Week program	
Edit program	
Change program name	
Copy program	
Delete program	
Add new section	

Program editor: “Edit program” menu.

Select the desired function and press the **Confirm** icon.

The program editor offers following options:

- Change program name. This menu also offers to configure the ramp / step mode setting (chap. 10.6.1).
- Copy program
- Replace program: Replacing an new or an existing program with the copied program. This menu point is visible only after a section has been copied.
- Delete program
- Add new section

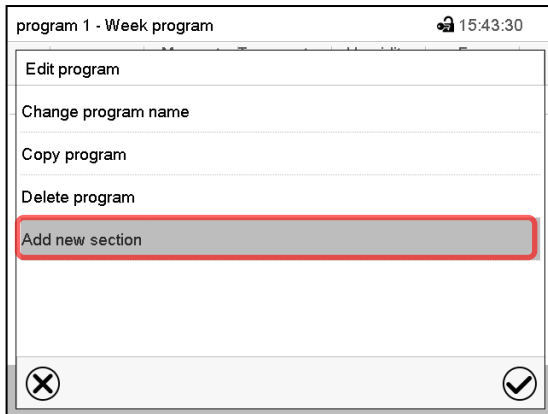

To add a new section, select “Add new section” and press the **Confirm** icon.

The program view opens.

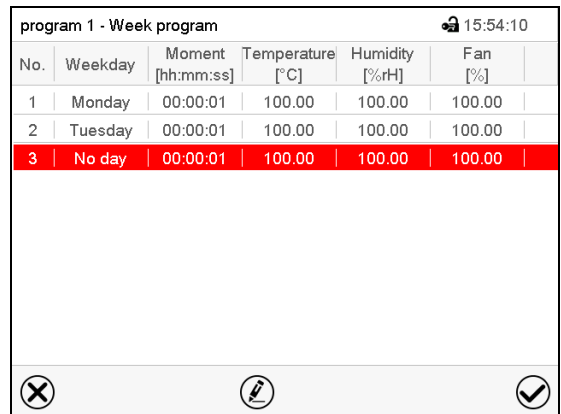

Program view.

With a new section no weekday is specified. Therefore the section is first marked in red and cannot be saved.

A new section is always added at the very bottom (example: section 3). When the section start is specified the sections are automatically arranged in the correct chronological order.

10.5 Section editor: Section management

Path: **Main menu > Programs > Week program**

Select the desired program.

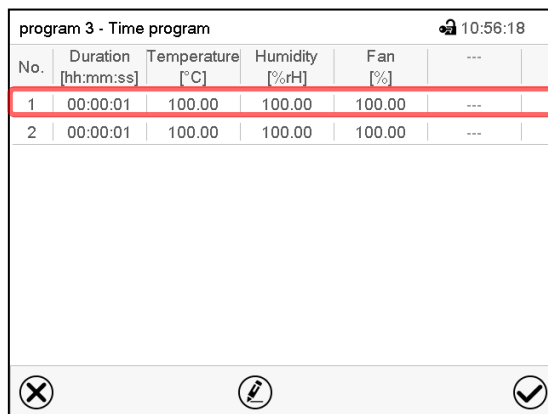

Program view.

Select the desired program section (example: section 1)

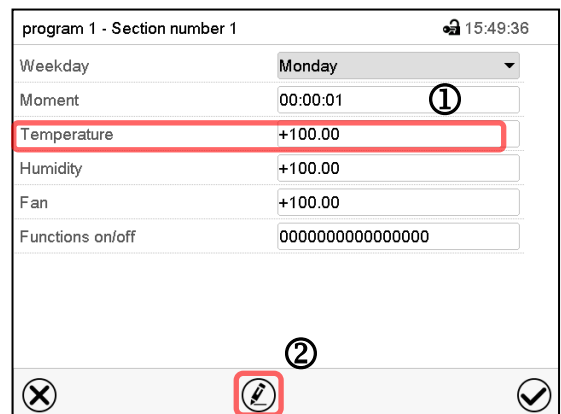

Section view (example: section 1).

There are the following options:

- ① Select a parameter to enter or modify the according value (chap. 10.6)
- ② Press the **Edit** icon to open the program editor

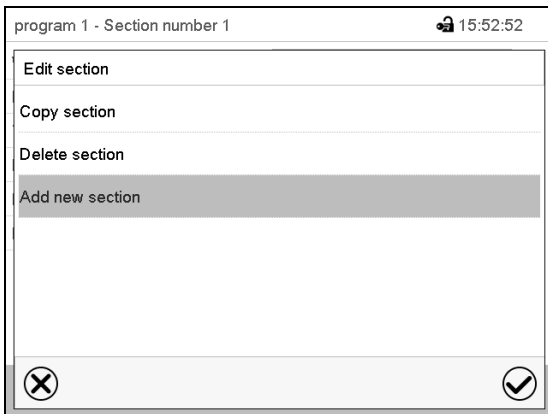

Section editor: “Edit section” menu

Select the desired function and press the **Confirm** icon.

The section editor offers following options:

- Copy section
- Replace section: Replacing an existing section with the copied section. This menu point is visible only after a section has been copied.
- Insert section: Adding the copied section. This menu point is visible only after a section has been copied.
- Delete section
- Add new section

10.5.1 Add a new section

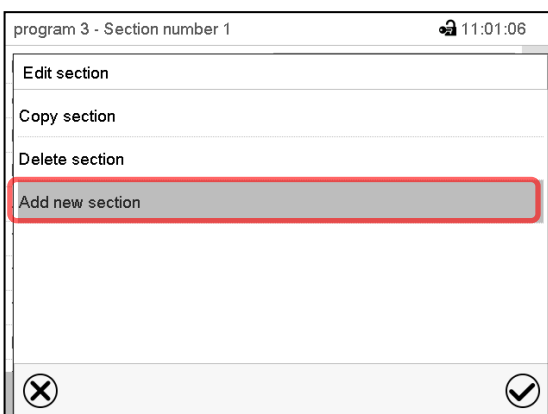

Section editor: “Edit section” menu.

Select “Add new section” and press the **Confirm** icon.

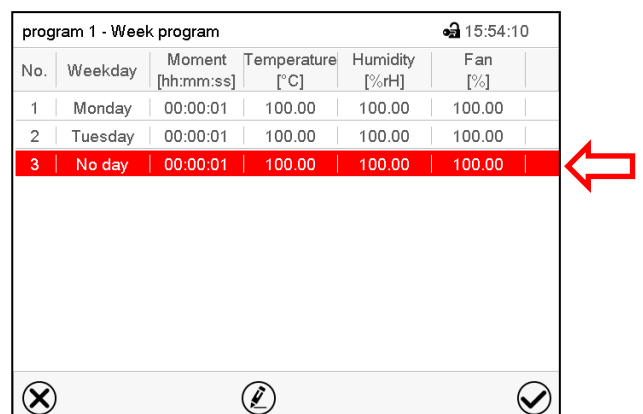
No.	Weekday	Moment [hh:mm:ss]	Temperature [°C]	Humidity [%rH]	Fan [%]
1	Monday	00:00:01	100.00	100.00	100.00
2	Tuesday	00:00:01	100.00	100.00	100.00
3	No day	00:00:01	100.00	100.00	100.00

Program view.

With a new section no weekday is specified. Therefore the section is first marked in red and cannot be saved.

A new section is always added at the very bottom (example: section 3). When the section start is specified the sections are automatically arranged in the correct chronological order.

10.5.2 Copy and insert or replace a section

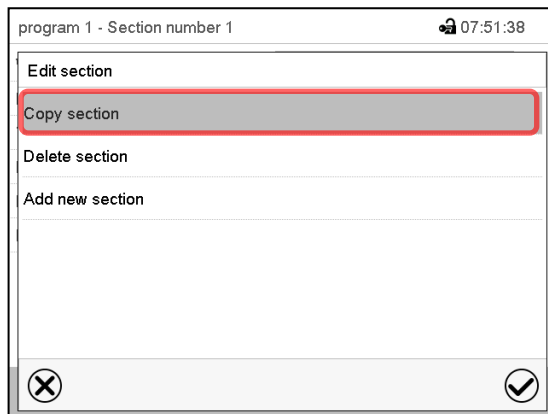

Section editor: “Edit section” menu

Select “Copy section” and press the **Confirm** icon.

The current section (example: section 1) is copied.

The controller returns to the program view.

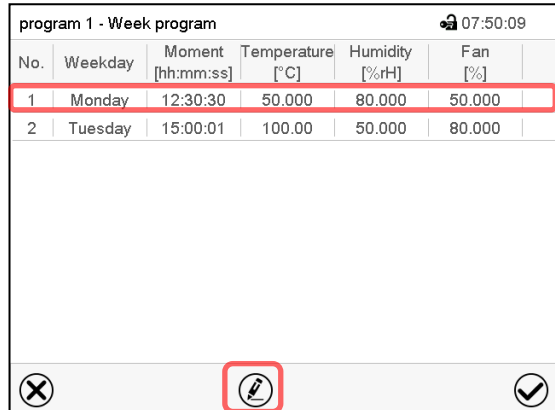
No.	Weekday	Moment [hh:mm:ss]	Temperature [°C]	Humidity [%rH]	Fan [%]
1	Monday	12:30:30	50.000	80.000	50.000
2	Tuesday	15:00:01	100.00	50.000	80.000

Program view

Select the section to be replaced or before or after which the copied section shall be inserted (example: section 2).

Press the **Confirm** icon

The controller returns to the section editor

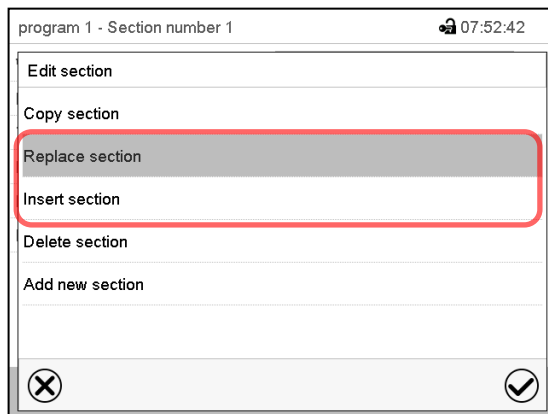

Section editor: “Edit section” menu

Select “Replace section” to replace the selected section with the copied section

or

Select “Insert section” to additionally add the copied section.

Press the **Confirm** icon.

If you selected “Insert section” the sections are automatically arranged in the correct chronological order.

10.6 Value entry for a program section

Path: **Main menu > Programs > Week program**

Select the desired program and section.

The setting and control ranges for the individual parameters are the same as for “Fixed value” operating mode (chap. 7).

10.6.1 Set-point ramp and set-point step modes

The explanation of the settings “Ramp” or “Step” is given in chap. 9.7.2.

You can define the type of temperature and humidity transitions for the entire week program.

Select the desired program and press the **Edit** icon to open the program editor. In the program editor select the “Change program name” function and press the **Confirm** icon.

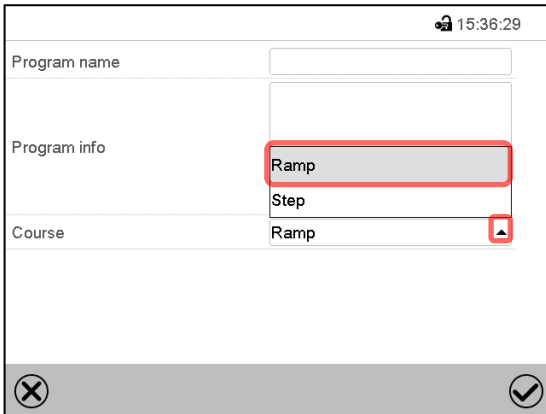

“Change program name” menu.

In the field “Course” select the desired setting “Ramp” or “Step” and press the **Confirm** icon.

10.6.2 Weekday

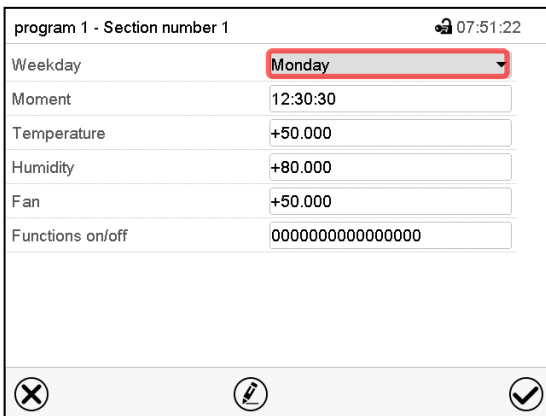

In the field “Weekday” select the desired weekday.

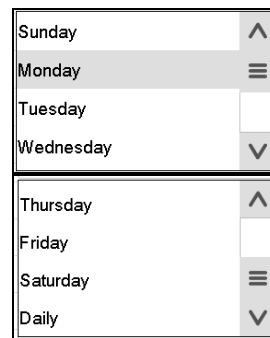

Section view.

With “Daily” selected, this section will run every day at the same time.

10.6.3 Start time

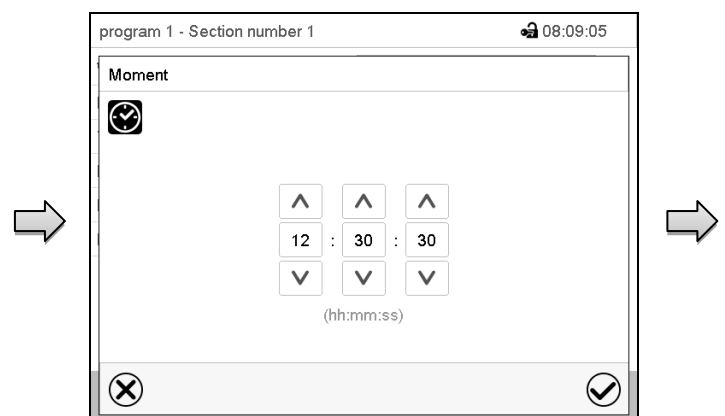
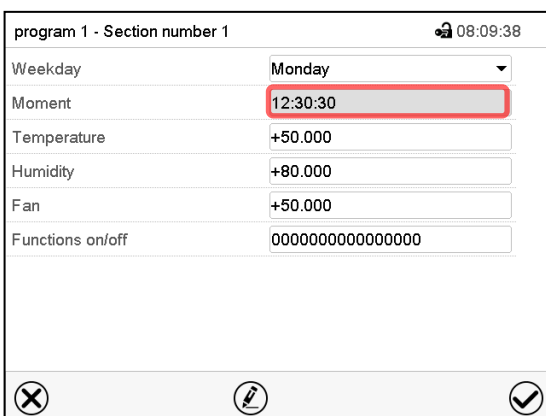

Section view.

Entry menu “Moment”.

Select the field “Moment”.

Select with the arrow keys the desired start moment of the section and press the **Confirm** icon.

10.6.4 Temperature setpoint

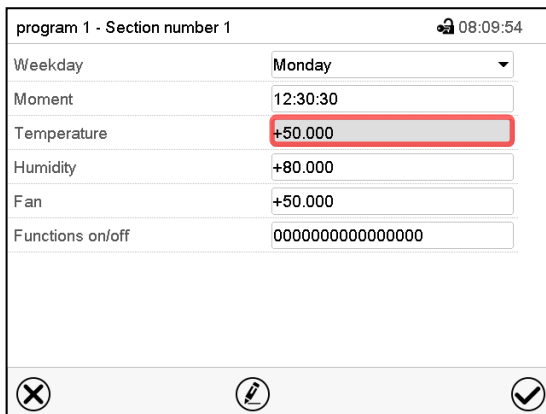

program 1 - Section number 1 08:09:54

Weekday: Monday

Moment: 12:30:30

Temperature: +50.000

Humidity: +80.000

Fan: +50.000

Functions on/off: 0000000000000000

Section view.

Select the field "Temperature".

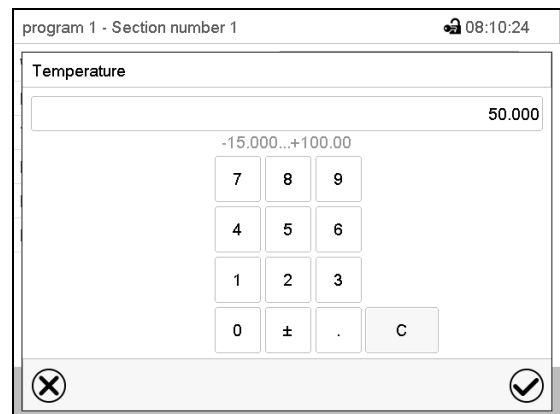
program 1 - Section number 1 08:10:24

Temperature

50.000

-15.000...+100.00

7 8 9

4 5 6

1 2 3

0 ± . C

"Temperature" entry menu.

Enter the desired temperature and press the **Confirm** icon.

Setting range:

KBF: -5 °C up to 70 °C, KMF: -15 °C up to 100 °C.

The controller returns to the section view.

10.6.5 Humidity setpoint

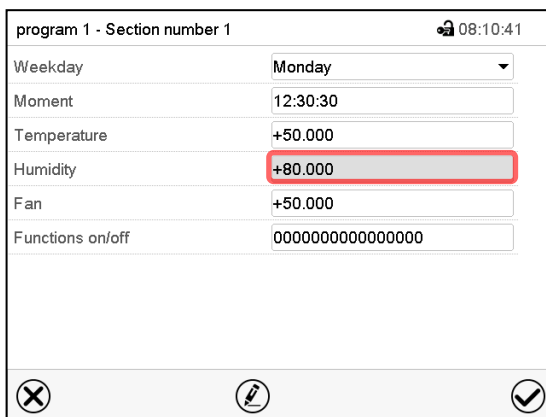

program 1 - Section number 1 08:10:41

Weekday: Monday

Moment: 12:30:30

Temperature: +50.000

Humidity: +80.000

Fan: +50.000

Functions on/off: 0000000000000000

Section view.

Select the field "Humidity".

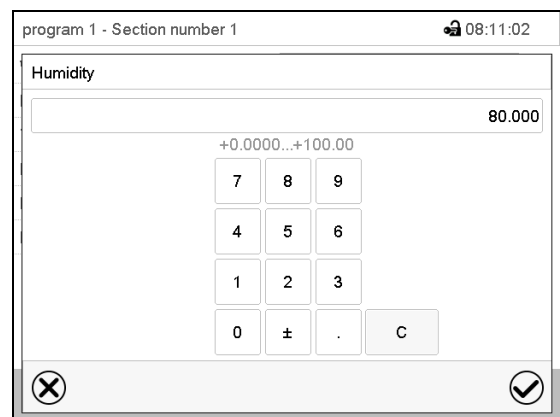
program 1 - Section number 1 08:11:02

Humidity

80.000

+0.0000...+100.00

7 8 9

4 5 6

1 2 3

0 ± . C

"Humidity" entry menu.

Enter the desired value for the humidity and press the **Confirm** icon.

Setting range:

KBF: 0% r.H. up to 80% r.H.,

KMF: 0% r.H. up to 100% r.H.

The controller returns to the section view.

10.6.6 Fan speed

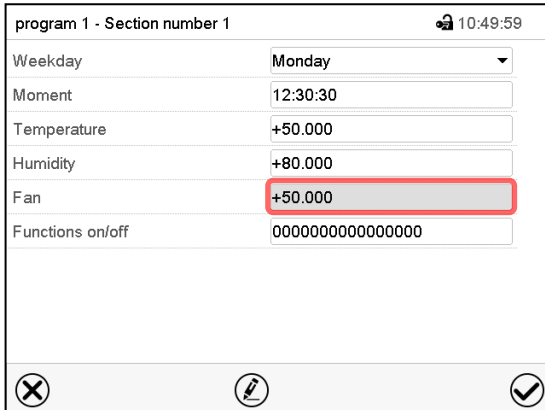

program 1 - Section number 1 10:49:59

Weekday	Monday
Moment	12:30:30
Temperature	+50.000
Humidity	+80.000
Fan	+50.000
Functions on/off	0000000000000000

Section view.

Select the field "Fan".

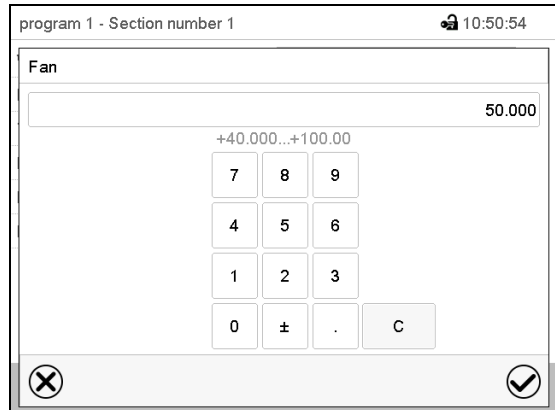
program 1 - Section number 1 10:50:54

Fan

50.000

+40.000...+100.00

7	8	9
4	5	6
1	2	3
0	±	.

C

"Fan" entry menu.

Enter the desired value for the fan speed and press the **Confirm** icon.

Setting range: 40% up to 100% fan speed.

The controller returns to the section view.

10.6.7 Special controller functions via operation lines

You can define the switching state of up to 16 operation lines (control contacts). They are used to activate / deactivate special controller functions.

- Operation line "Humidity off" serves to turn off the humidity.
- Operation line "Idle mode" activates / deactivates the operating mode "Idle mode".

The other operation lines are without function.

Select the desired program and section. You can set the operation lines in the "Functions on/off" field.

For details please refer to chap. 9.7.3.

10.7 Deleting a week program

Path: **Main menu > Programs > Week program**

Week program		🔒 08:39:23
No.	Program name	
26	program 1	
27	program 2	
28	< empty >	
29	< empty >	
30	< empty >	

“Week program” menu.

Select the program to be deleted.



program 1 - Week program						🔒 08:40:54
No.	Weekday	Moment [hh:mm:ss]	Temperature [°C]	Humidity [%rH]	Fan [%]	
1	Daily	08:00:00	37.000	100.00	100.00	
2	Monday	12:30:30	50.000	80.000	50.000	
3	Tuesday	15:00:01	100.00	50.000	80.000	
4	Friday	11:15:00	60.000	85.000	100.00	

“Program view”.

Press the **Edit** icon“.



program 1 - Week program		🔒 08:41:12
Edit program		
Change program name		
Copy program		
Delete program		
Add new section		

Program editor: “Edit program” menu.

Select “Delete program”.

11. Notification and alarm functions

11.1 Notification and alarm messages overview

11.1.1 Notifications

Notifications are indicated by **information icons** displayed in the screen header in Normal display

An information icon serves as an indication of a certain condition.



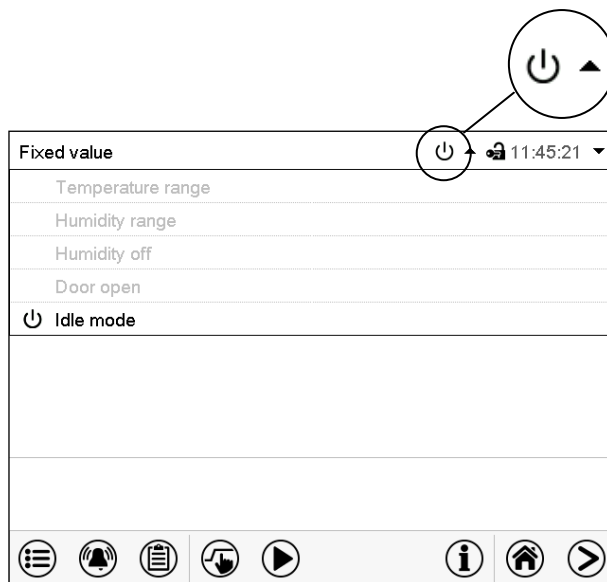

If this condition persists, in some cases an alarm will be triggered after a fix or configurable interval. As long as the condition persists, the information icon therefore continues to be displayed also in state of alarm. If during alarm the conditions ends, e.g., if during a tolerance range alarm the actual value returns to within the tolerance range, the information icon disappears, whereas the alarm will continue until manual acknowledgement.

Press the flash icon next to the information icon to access the corresponding text information.



Normal display showing the text information.

The currently valid information texts are highlighted in black (example: **Idle mode**)

Condition	Information icon	Text information	Start after condition occurred
The controller is in Idle mode (chap. 5.4).		Idle mode	immediately
The current actual temperature value is outside the tolerance range (chap. 11.4)		Temperature range	immediately
The current actual humidity value is outside the tolerance range (chap. 11.4)		Humidity range	immediately
The humidification / dehumidification system is turned off (via operation line and/or by setting "Control on/off") or Temperature setpoint below 0 °C or above 95 °C		Humidity off	immediately
Chamber door open		Door open	immediately

Notifications are not shown in the event list.

11.1.2 Alarm messages

Condition	Alarm message	Start after condition occurred	Zero-voltage relay alarm output (option)
The current actual temperature value is outside the tolerance range (chap. 11.4)	Temperature range	after configurable time	time as alarm start
The current actual humidity value is outside the tolerance range (chap. 11.4)	Humidity range	after configurable time	time as alarm start
Chamber door open	Door open	after 5 minutes	----
Power failure	---	----	immediately
Exceeded setpoint of the safety controller class 3.1	Safety controller	immediately	----
Exceeded maximum or minimum temperature (option temperature safety device class 3.3)	Temp. safety device	immediately	----
Temperature sensor defective	e.g. ---- or <-<-< or >->->	immediately	----
Safety controller temperature sensor defective	Safety controller sensor	immediately	----

Alarm messages are displayed in the list of active alarms until acknowledging them. They are also shown in the event list.

11.1.3 Messages concerning the humidity system

Condition and measures	Message	Start after condition occurred
The humidity module is defective. Contact BINDER service	Humidity system	immediately
The humidity module cannot fill up. <i>In case of freshwater supply via water pipe:</i> The water tap is closed, or the chamber is defective. <i>In case of freshwater supply via freshwater can (option, chap. 19.9):</i> Water can is empty. Humidification is turned off. In case of refrigerating operation, the interior is strongly dehumidified. When the water supply is functional again, the humidity system restarts, or the chamber is defective.	Freshwater supply	immediately
The humidity module cannot empty the condensate tank. Check the length and location of the wastewater tube. If appropriate contact BINDER service.	Waste water	immediately
Purging is required soon. Turn off and on again the humidity switch to start purging. After a successful purging the notification resets automatically.	Humidity system purging req.	after predefined time (approx. 3-5 months depending on use)
Maintenance of the humidity system is required. Contact BINDER service.	Humidity module service	after predefined time (approx. 1 year)

Messages concerning the humidity system are shown in the event list.



When operating the chamber without water connection, turn off humidity control in the “set-points” menu (chap. 6.3) in order to avoid humidity alarms.

11.2 State of alarm

1. Visual indications in Normal display: alarm message, screen header flashing in red color

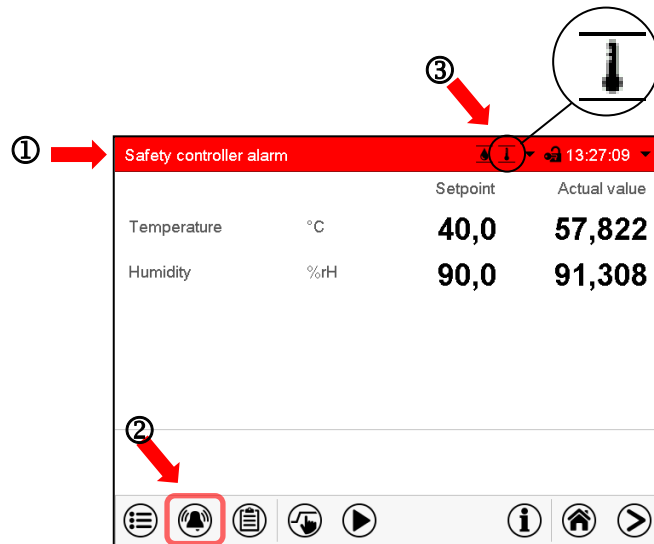

Normal display in state of alarm (example).

- ① Screen header flashing in red color and showing the alarm message
- ② **Alarm** icon on the bottom of the screen: change to the list of active alarms and alarm acknowledgement
- ③ If applicable, information icon in the screen header. Indication of a certain condition

2. Audible alert, if the buzzer is enabled (chap. 11.5).
3. Switching the zero-voltage relay alarm output (option, chap. 19.5) to transmit the alarm e.g., to a central monitoring system.

11.3 Resetting an alarm, list of active alarms

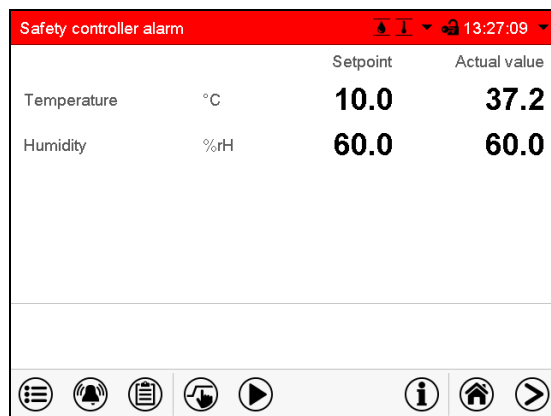

Normal display in state of alarm (example).

Press the **Alarm** icon

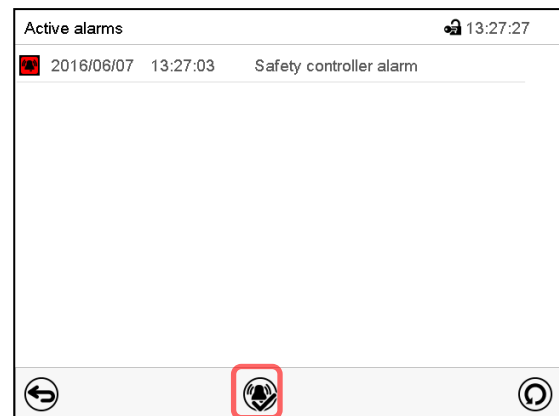

List of active alarms.

Press the **Reset alarm** icon.

Pressing the **Reset alarm** icon mutes the buzzer for all active alarms. The icon then disappears.

- Acknowledging while the alarm condition persists: Only the buzzer turns off. The visual alarm indication remains on the controller display. The alarm remains in the list of active alarms.

When the alarm condition has ended, the visual alarm indication is automatically cleared. The alarm is then no longer in the list of active alarms.

- Acknowledging after the alarm condition has ended: The buzzer and the visual alarm indication are reset together. The alarm is then no longer in the list of active alarms.
- The zero-voltage relay alarm output resets together with the alarm.

11.4 Tolerance range settings

In this menu you can set the deviation between the actual value and setpoint which shall cause a tolerance range alarm.

This function only activates after the set-point has been reached once.

Path: **Main menu > Settings > Various**

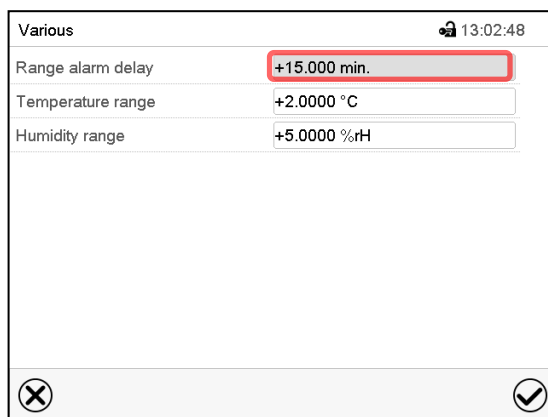

Submenu "Various".

Select the field "Range alarm delay".

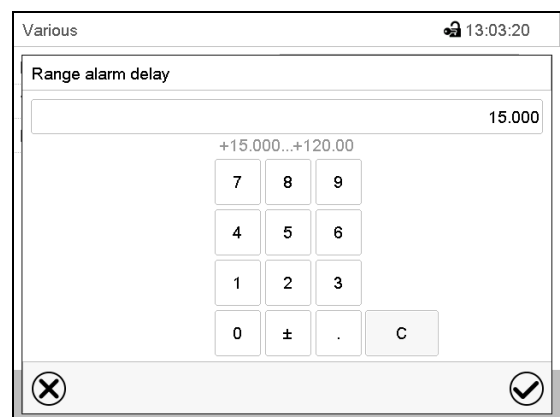

Entry menu "Range alarm delay".

Enter the time in minutes, after which the range alarm shall be triggered and press the **Confirm** icon.

Setting range: 15 min to 120 min.

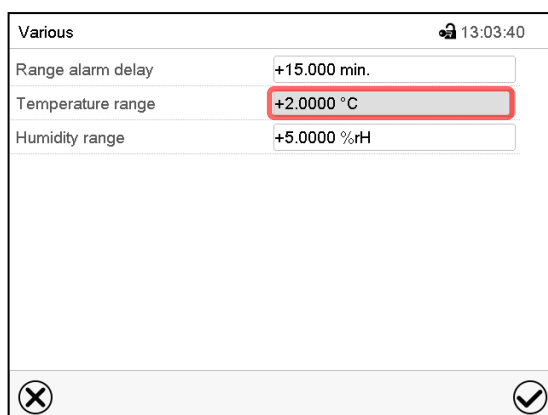

Submenu "Various".

Select the field "Temperature range".

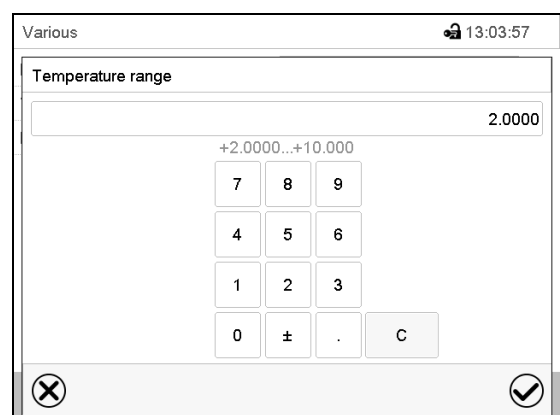

"Temperature range" entry menu.

Enter the desired value for the temperature range and press the Confirm icon.

Setting range: 2 °C to 10 °C

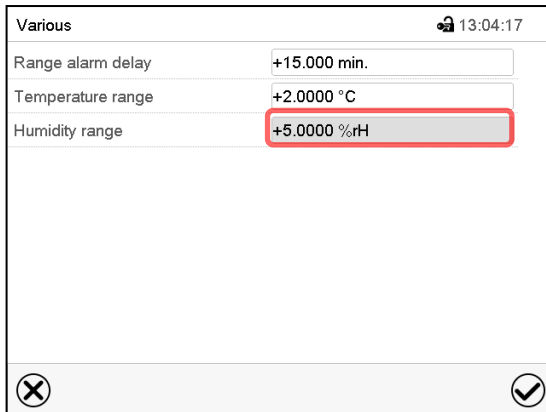

Submenu "Various".
Select the field "Humidity range".

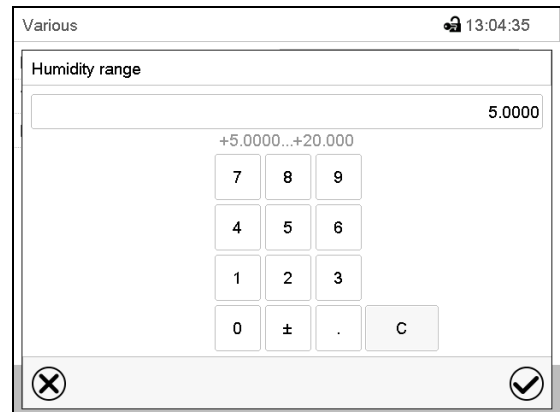

"Humidity range" entry menu.
Enter the desired value for the humidity range and press the Confirm icon.
Setting range: 5% r.H. to 20% r.H.

There are the following possibilities:

	Press the Confirm icon to take over the entries and exit the menu.
	Press the Close icon to exit the menu without taking over the entries.

If there are actual values outside the tolerance range the following information icons for the corresponding parameter are displayed:

Icon	Signification	Information
	Temperature range	The temperature value is outside the tolerance range
	Humidity range	The humidity value is outside the tolerance range

If the condition persists, an alarm is triggered after the configured interval ("range alarm delay"). It is visually indicated in Normal display. If the alarm buzzer is activated (chap. 11.5) there is an audible alert. The zero-voltage relay alarm output (option, chap. 19.5) switches to transmit the alarm. The alarm is shown in the list of active alarms (chap. 11.3).

11.5 Activating / deactivating the audible alarm (alarm buzzer)

Path: **Main menu > Settings > Chamber**

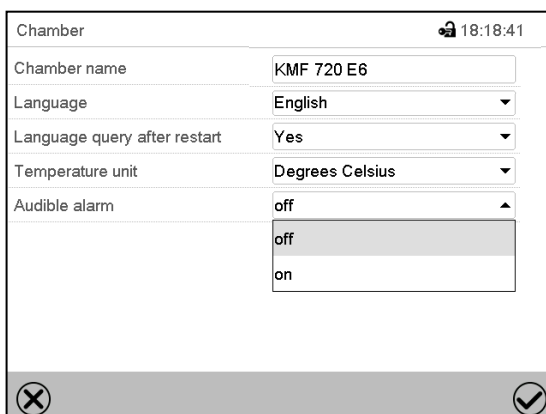

"Chamber" submenu.
In the field "Audible alarm" select the desired setting "off" or "on" and press the **Confirm** icon.

12. Temperature safety devices

12.1 Over temperature protective device (class 1)

The chamber is equipped with an internal temperature safety device, class 1 acc. to DIN 12880:2007. It serves to protect the chamber and prevents dangerous conditions caused by major defects.

If a temperature of approx. 110 °C / 230 °F is reached, the over temperature protective device permanently turns off the chamber. The user cannot restart the device again. The protective cut-off device is located internally. Only a service specialist can replace it. Therefore, please contact an authorized service provider or BINDER Service.

12.2 Overtemperature safety controller class 3.1

The chambers are regularly equipped with an electronic overtemperature safety controller (temperature safety device class 3.1 according to DIN 12880:2007). The safety controller is functionally and electrically independent of the temperature control system. If an error occurs, it performs a regulatory function.



With option temperature safety device class 3.3 (chap. 12.3), the safety controller is **not** used. It must be set to the maximum limit value (KBF: 70 °C / 158 °F, KMF: 100 °C / 212 °F).

Please observe the DGUV guidelines 213-850 on safe working in laboratories (formerly BGI/GUV-I 850-0, BGR/GUV-R 120 or ZH 1/119, issued by the employers' liability insurance association) (for Germany).

The overtemperature safety controller serves to protect the chamber, its environment and the contents from exceeding the maximum permissible temperature. In the case of an error, it limits the temperature inside the chamber to the entered safety controller set-point. This condition (state of alarm) is indicated visually and additionally with an audible alert if the buzzer is enabled (chap. 11.5). The alarm persists until the chamber cools down below the configured safety controller setpoint.



Check the setting regularly and adjust it following changes of the set-point or charge.

12.2.1 Safety controller modes

You can select between "Limit (absolute)" and "Offset (relative)" safety controller mode

- **Limit:** Absolute maximum permitted temperature value

This setting offers high safety as a defined temperature limit will not be exceeded. It is important to adapt the safety controller set-point after each modification of the temperature set-point. Otherwise, the limit could be too high to ensure efficient protection, or, in the opposite case, it could prevent the controller from reaching an entered set-point outside the limit range.

- **Offset:** Maximum overtemperature above any active temperature set point. The maximum temperature changes internally and automatically with every set-point change.

This setting is recommended for program operation. It is important to check the safety controller set-point and safety controller mode occasionally, as it does not offer a fix, independent limit temperature value, which would never be exceeded.

Example: Desired temperature value: 40 °C, desired safety controller value: 45 °C.
Possible settings for this example:

Temperature set point	Safety controller mode	Safety controller set-point
40 °C	Limit (absolute)	45 °C
	Offset (relative)	5 °C

12.2.2 Setting the safety controller

	Press the Setpoint setting icon to access the “Setpoint” setting menu from Normal display.
	Press the Back icon to go return to Normal display from any menu.

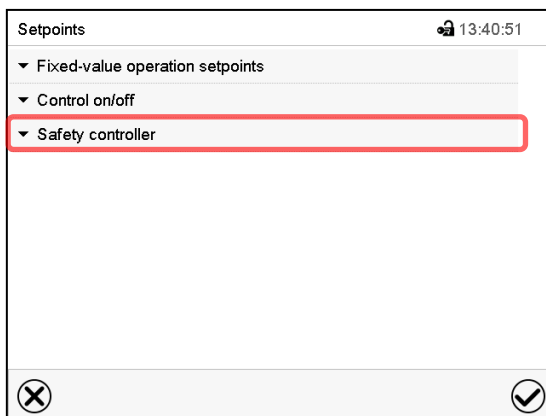

“Setpoints” menu.

Select “Safety controller”.

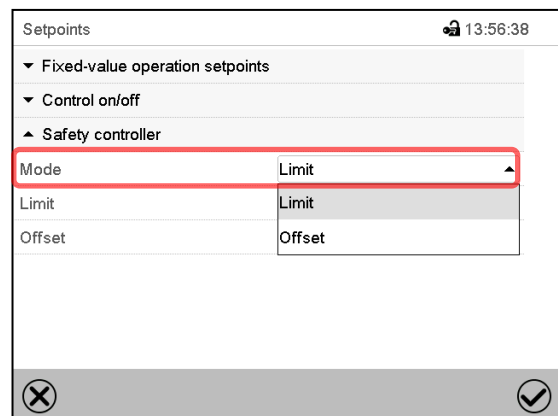

“Setpoints” menu.

In the field “Mode” select the desired setting “Limit” or “Offset”.

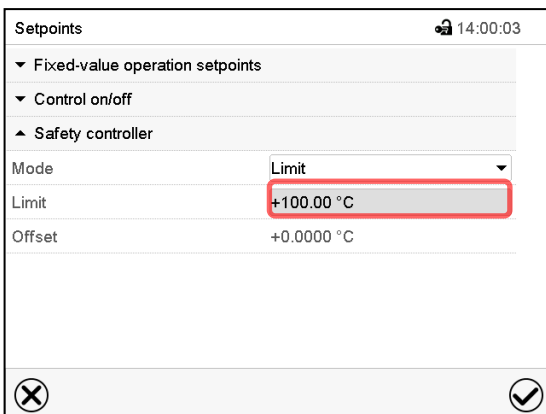

“Setpoints” menu.

Select the corresponding field “Limit” or “Offset” (example: “Limit”)

Or

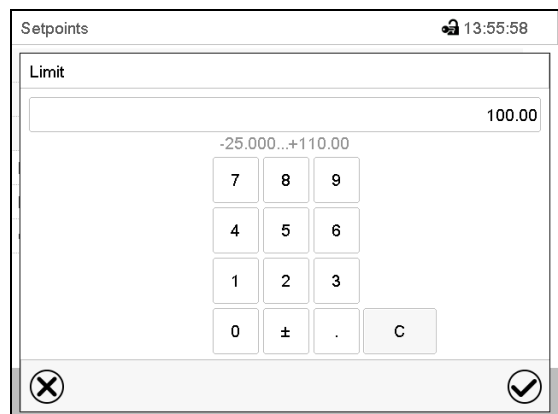

“Limit” entry menu.

Enter the desired safety controller setpoint and press the **Confirm** icon.

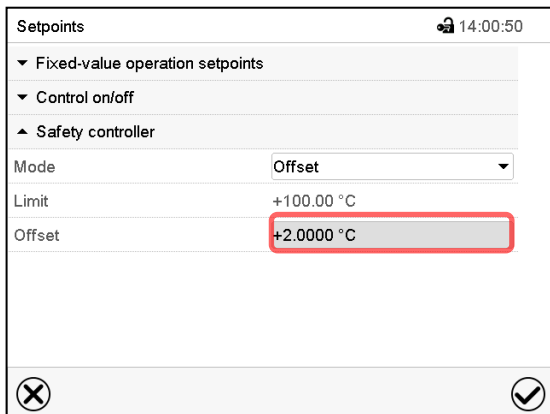

“Setpoints” menu.

Select the corresponding field “Limit” or “Offset” (example: “Offset”)

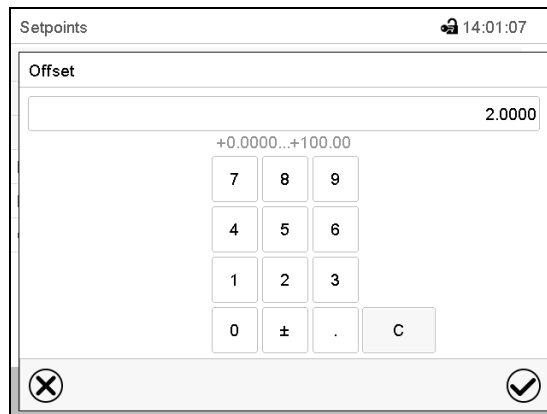

“Offset” entry menu.

Enter the desired safety controller setpoint and press the **Confirm** icon.



Regularly check the safety controller setting for set-point type “Limit” or “Offset”

- in Fixed value operating mode according to the entered set-point temperature value
- in program mode according to the highest temperature value of the selected temperature program

Set the safety controller set-point by approx. 2 °C to 5 °C above the desired temperature set-point.

12.2.3 Message and measures in the state of alarm

The state of alarm is indicated visually in Normal display by the alarm message “Safety controller alarm” and the screen header flashing in red color. If the buzzer is enabled (chap. 11.5) there is an additional audible alert (chap. 11.2). The alarm remains active until it is acknowledged on the controller and the inner temperature falls below the set safety controller setpoint. Then the heating is released again.

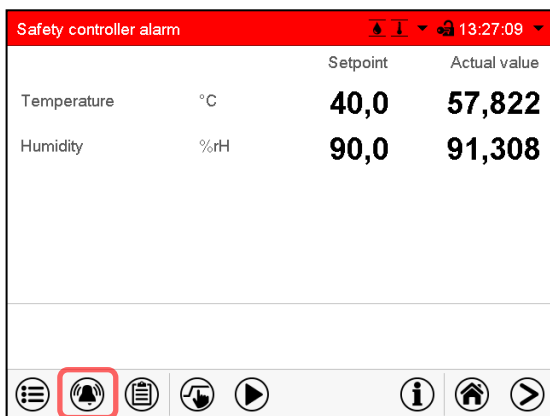

Normal display with safety controller alarm.

Press the **Alarm** icon

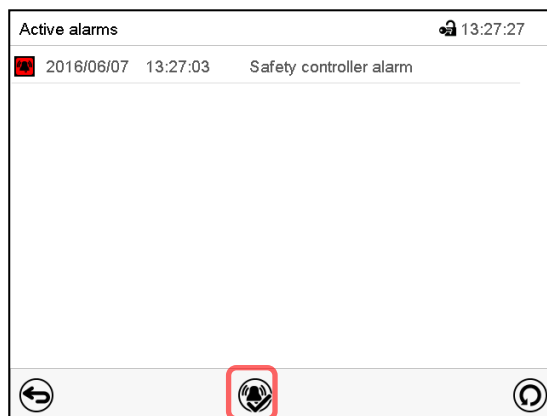

List of active alarms.

Press the **Reset alarm** icon.

12.2.4 Function check

Check the safety controller at appropriate intervals for its functionality. It is recommended that the authorized operating personnel should perform such a check, e.g., before starting a longer work procedure.

12.3 Temperature safety device class 3.3 (option)

With the option over/under temperature protective device (temperature safety device class 3.3 acc. to DIN 12880:2007) the chamber is equipped with two additional safety devices (class 3.1 and class 3.2). The combination of the safety devices is regarded as a safety device class 3.3.

The temperature safety device, class 3.3, serves to protect the constant climate chamber, its environment and the contents from exceeding the maximum permissible temperature. Please observe the DGUV guidelines 213-850 on safe working in laboratories (formerly BGI/GUV-I 850-0, BGR/GUV-R 120 or ZH 1/119, issued by the employers' liability insurance association) (for Germany).

With **safety device class 3.1** a maximum value for the temperature is set that the chamber will not exceed due to the regulatory function of the safety device class 3.1. This protection against excessively high temperatures can, for example, serve to protect the constant climate chamber, its environment and the material under treatment from excess temperatures.

With **safety device class 3.2** a minimum value for the temperature is set that the chamber will not fall below due to the regulatory function of the safety device class 3.2. This protection against excessively low temperatures can, for example, serve to protect sensitive loads from under cooling.

Both safety devices are functionally and electrically independent of the temperature control system. If an error occurs, they perform regulatory function.

Safety devices class 3.1 (8) and class 3.2 (9) are located in the left lateral control panel.

 With option temperature safety device class 3.3, the safety controller (chap. 12.2) must be set to the maximum limit value (KBF: 70 °C / 158 °F, KMF: 100 °C / 212 °F).

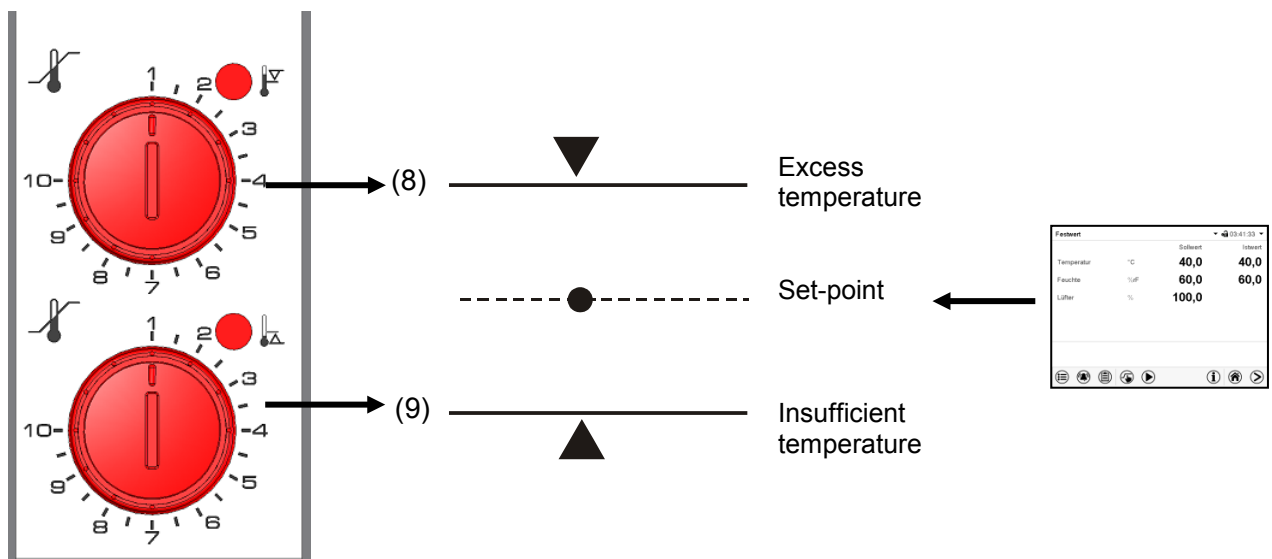
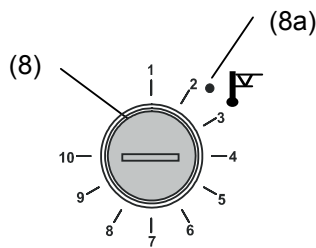

Figure 16: Temperature safety device class 3.3

12.3.1 Temperature safety device class 3.1



If you turn the control knob (8) to its end-stop (position 10), the safety device class 3.1 protects the appliance. If you set the temperature a little above the set-point, it protects the charging material.

If the safety device class 3.1 has taken over control, identifiable by the red alarm lamp (8a) lighting up, the message "**Temp. safety device**" on the controller will be displayed and the buzzer will sound, then proceed as follows:

- Reset the buzzer by pressing the "RESET" key on the controller
- Disconnect the chamber from the power supply
- Have an expert examine and rectify the cause of the fault.
- Start up the chamber again

Setting:

To check the response temperature of the safety device class 3.1, turn on the chamber and set the desired set point at the temperature controller.

The sections of the scale from 1 to 10 correspond to the temperature range from 0 °C / 32 °F to 120 °C / 248 °F and serve as a setting aid.

- Turn the control knob (8) of the safety device using a coin to its end-stop (position 10) (chamber protection).
- When the set point is reached, turn back the control knob (8) until its trip point (turn it counter-clockwise).
- The trip point is identifiable by the red alarm lamp (8a), the message "**Temp. safety device**" on the controller display, and the buzzer sounds. Reset the buzzer with the "RESET" key on the controller.
- The optimum setting for the safety device is obtained by turning the control knob clockwise by approximately two scale divisions, which shuts off the red alarm lamp (8a).

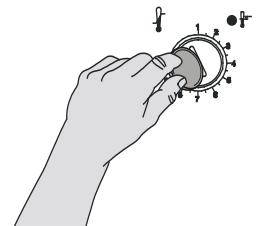

Figure 17: Setting safety device class 3.1



Check the setting regularly and adjust it following changes of the set-point or charge.

Function check:

Check the temperature safety device class 3.1 at appropriate intervals for its functionality. It is recommended that the authorized operating personnel should perform such a check, e.g., before starting a longer work procedure.

12.3.2 Temperature safety device class 3.2

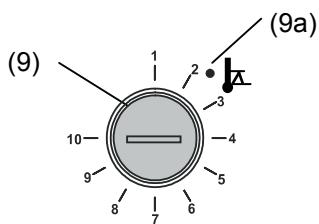

The safety device class 3.2 is equivalently set to a minimum temperature the chamber will not fall below. This protection against prohibited low temperatures can, for example, serve to protect sensitive cultures from cooling down too much.

If the control knob (9) is turned to its minimum (position 1), the safety device class 3.2 has no effect. If it is set to a temperature somewhat lower than that selected by means of the controller, it functions as a protective device for the material under treatment.

If the temperature safety device class 3.2 has assumed regulation, identifiable by the red alarm lamp (9a) lighting up, the message “**Temp. safety device**” on the controller display, and the buzzer sounds, please proceed as follows:

- Reset the buzzer with the “RESET” key on the controller.
- Disconnect the chamber from the power supply.
- Have an expert examine and rectify the cause of the fault.
- Start up the chamber again

Setting:

To check the response temperature of the safety device class 3.2, put the chamber into operation and set the desired set point at the temperature controller.

The sections of the scale from 1 to 10 correspond to the temperature range from $-40\text{ }^{\circ}\text{C}$ / $-40\text{ }^{\circ}\text{F}$ to $+160\text{ }^{\circ}\text{C}$ / $320\text{ }^{\circ}\text{F}$ and serves as a setting aid.

- Turn the control knob (9) of the safety device by means of a coin to position 1 (thermostat without effect).
- When the set point is reached, reset the safety device to its trip point (turn it clockwise).
- The trip point is identifiable by the red alarm lamp (9a), the message “**Temp. safety device**” on the controller display, and the buzzer sounds. Reset the buzzer with the “RESET” key on the controller.
- The optimum setting for the safety device is obtained by turning the control knob counter-clockwise by approximately two scale divisions, which shuts off the red alarm lamp (9a).

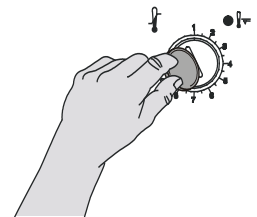

Figure 18: Setting safety device class 3.2



Check the setting regularly and adjust it following changes of set-point or charge.

Function check:

Check the temperature safety device class 3.2 at appropriate intervals for its functionality. It is recommended that the authorized operating personnel should perform such a check, e.g., before starting a longer work procedure.

13. User management

13.1 Authorization levels and password protection

The available functions depend on the current authorization level “Master”, “Service”, “Admin” or “User”.

The authorization levels are hierarchical: Every authorization includes all functions of the next lower level.

“Master” authorization level

- Highest authorization level, only for developers
- Extensive authorization for controller operation and configuration, outputs/inputs, alarm settings, parameter sets and operating ring display
- All passwords can be changed in the “log out” submenu (chap. 13.3).

“Service” authorization level

- Authorization level only for BINDER service
- Extensive authorization for controller operation and configuration, access to service data
- The passwords for “Service”, “Admin” and “User” authorization levels can be changed in the “log out” submenu (chap. 13.3).

“Admin” authorization level

- Expert authorization level, for the administrator
- Authorization for controller configuration and network settings and for operating those controller functions required for operating the chamber. Restricted access to service data.
- Password (factory setting): “2”.
- The passwords for “Admin” and “User” authorization levels can be changed in the “log out” submenu (chap. 13.3).

“User” authorization level

- Standard authorization level for the chamber operator
- Authorization for operating the controller functions required for operating the chamber.
- No authorization for controller configuration and network settings. The “Settings” and “Service” submenus of the main menu are not available.
- Password (factory setting): “1”
- The password for the “User” authorization level can be changed in the “log out” submenu (chap. 13.3).

As soon as a password has been assigned for an authorization level, the access to this level and the related controller functions are only available after log-in with the appropriate password.

If for an authorization level no password is assigned, the related controller functions of this level are available for every user without login.

If passwords have been assigned for all authorization levels, access to the controller functions is locked without login.

Operation after user login

At user login, the authorization level is selected and confirmed by entering the respective password.

Following user login, controller operation is available, recognizable by the open-lock icon in the header. The available controller functions correspond to the user's authorization level.

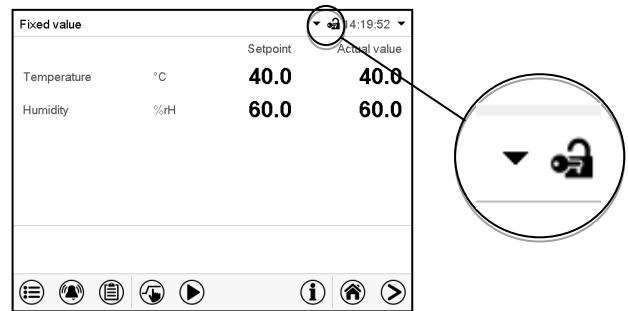

Password protection activated for all levels: operation without user login is locked

If passwords have been assigned for all authorization levels, the controller is locked without registration of a user.

As long as no user is registered, controller operation is locked, recognizable at the closed-lock icon in the header. This requires that the user management has been activated by the assignment of passwords for the individual authorization levels.

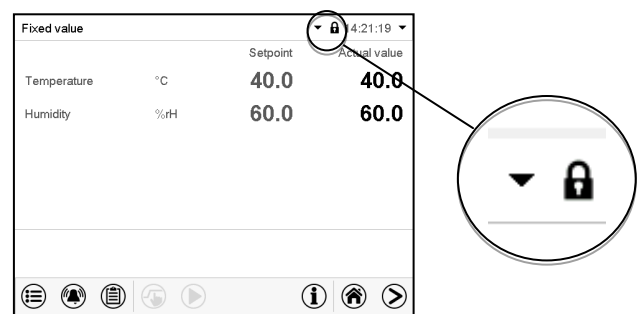

Password protection for at least one level deactivated: operation without user login is possible

If passwords have not been assigned for all authorization levels, after turning on the chamber there are those controller functions available, which correspond to the highest authorization level without password protection.

No lock icon is shown in the display header.

User login is neither required nor possible.

To activate the password protection and user login, perform new password assignment (chap. 13.5.3).

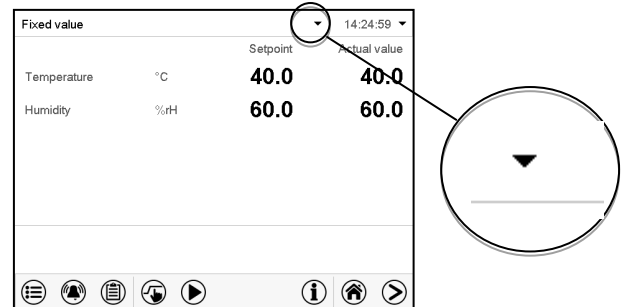

Information window

To check the authorization level of the user currently logged-in, select in Normal display the arrow far right in the display header.

Fixed value		14:19:52	
	Setpoint	Actual value	
Temperature	°C	40.0	40.0

The information window shows date and time, the controller's free memory space and under "Authorization" the authorization level of the current user.

If passwords have been assigned for all authorization levels, a user without login (password entry) has no authorization. There are only viewing functions available.

Fixed value		14:32:10	
Tuesday, 2016/05/24			
Authorization:		Free storage:	98%

Display when all authorization levels are password protected and no user has logged in:

No authorization level is displayed.

If passwords have been assigned only for some of the authorization levels, a user without login (password entry) has access to the functions of the highest authorization level without password protection.

Fixed value		14:29:26	
Tuesday, 2016/05/24			
Authorization:	Admin	Free storage:	98%

Display when only some of the authorization levels are password protected (example: no protection for the "User" and "Admin" levels) and no user has logged in:

The user's effective authorization (due to lack of password protection) is shown.

Example: user with "Admin" authorization.

If passwords have been assigned for some or all of the authorization levels, user login (password entry) provides the authorization for the corresponding password-protected level.

Fixed value		14:29:26	
Tuesday, 2016/05/24			
Authorization:	Admin	Free storage:	98%

Display when at least some of the authorization levels are password protected and a user has logged in.

The user's authorization (by password entry) is shown.

Example: user with "Admin" authorization.

13.2 Log in

Path: **Main menu > User > Log in**

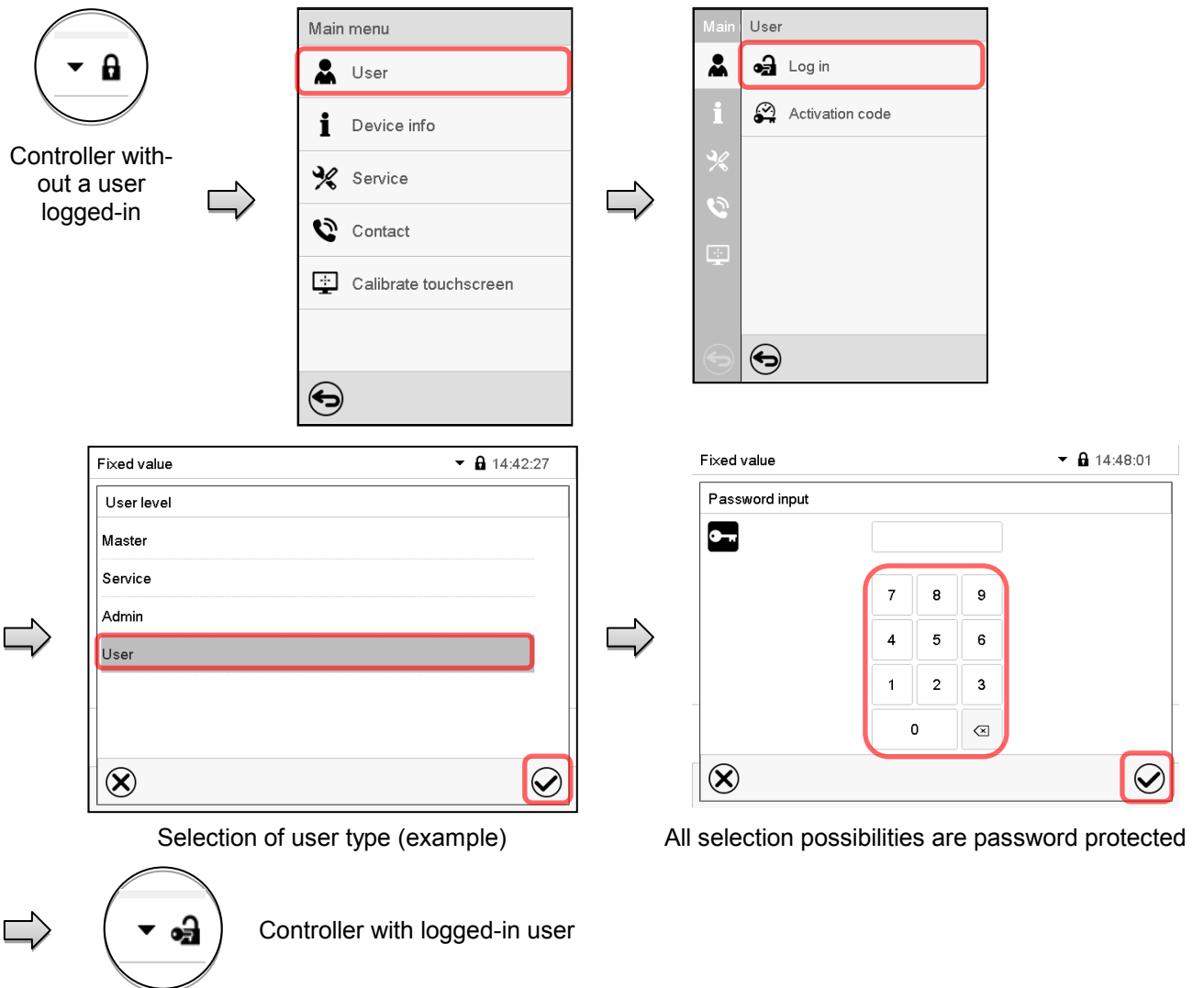

There are the following possibilities:

	Press the Confirm icon to take over the entries and exit the menu.
	Press the Close icon to exit the menu without taking over the entries.

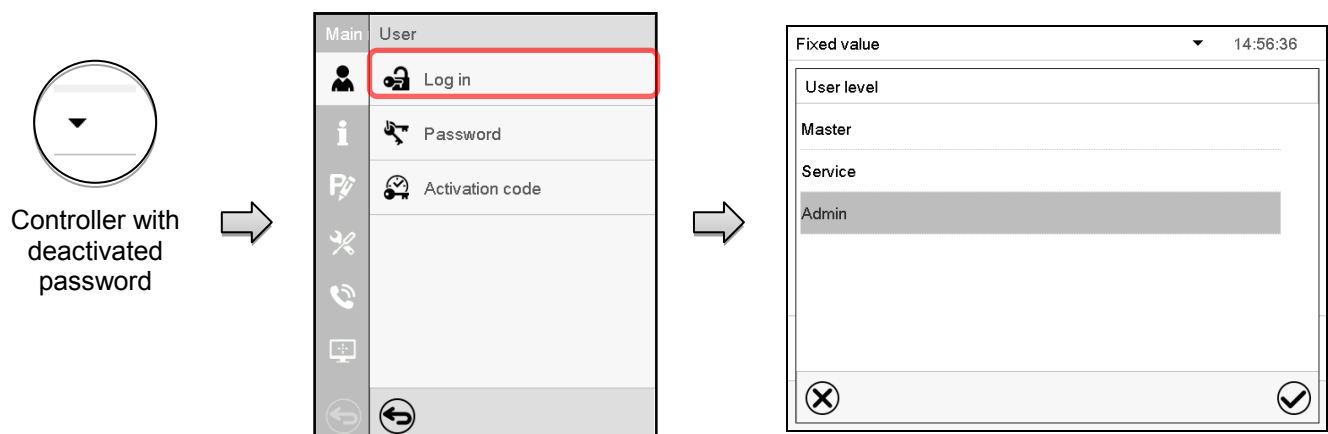

13.3 Log out

Path: **Main menu > User > Log out**

User logoff with “Admin” authorization

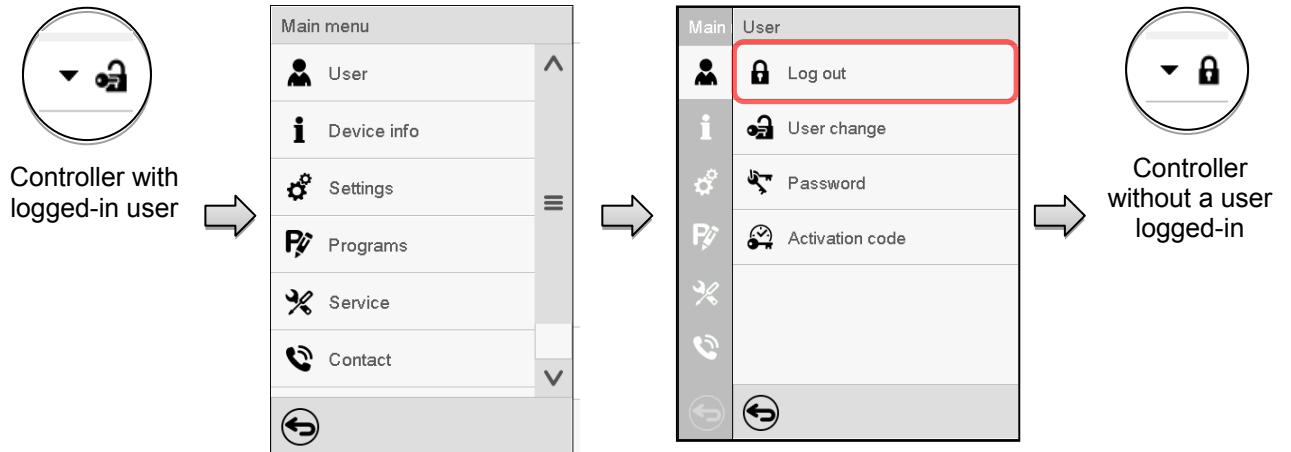

User logoff with “Admin” authorization

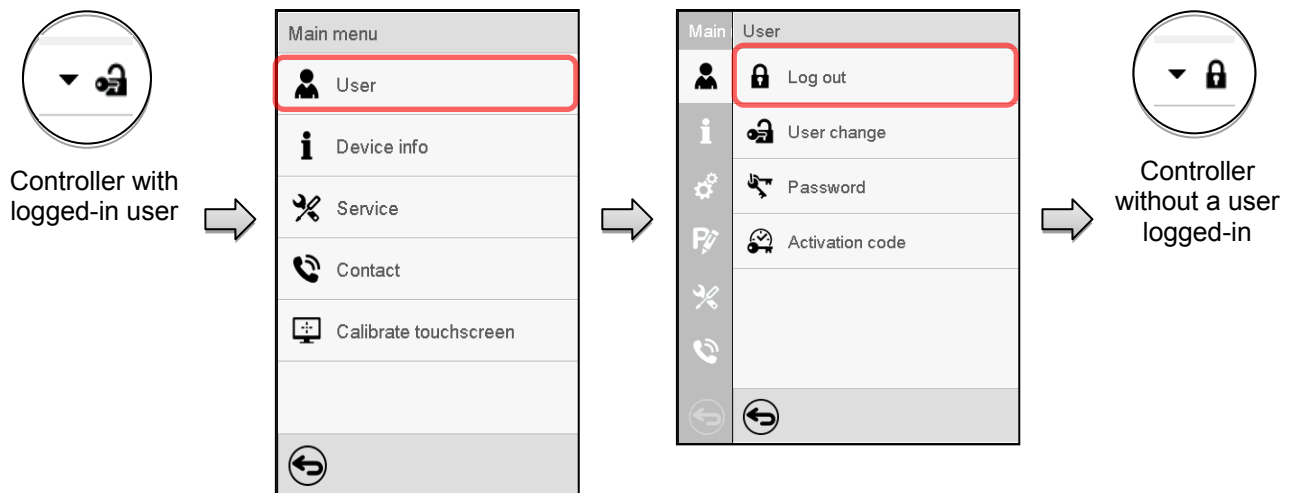

13.4 User change

If the password function has been deactivated (chap.13.5.2) this function is not available.

Path: **Main menu > User > User change**

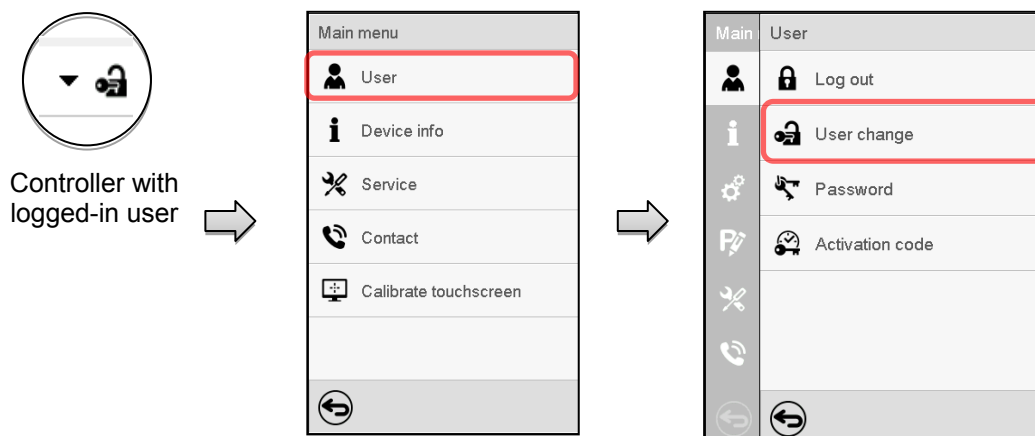

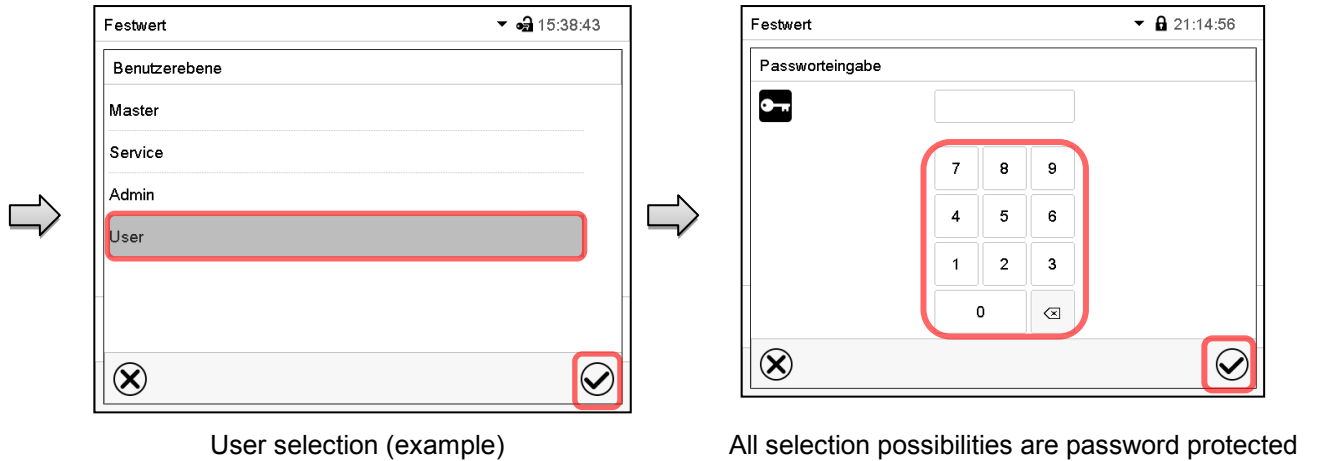

13.5 Password assignment and password change

This function is not available for a user logged-in with "User" authorization.

13.5.1 Password change

A logged-in user can change the passwords of his current level and of the next lower level(s).

Example: A user with "Admin" authorization can change the passwords for the "Admin" and "User" authorization levels.

Path: **Main menu > User > Password**

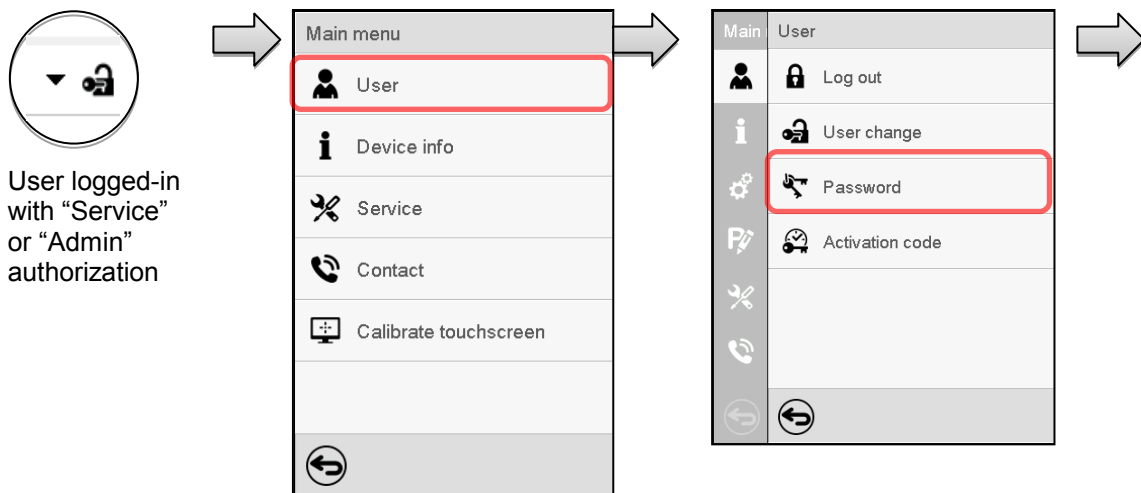

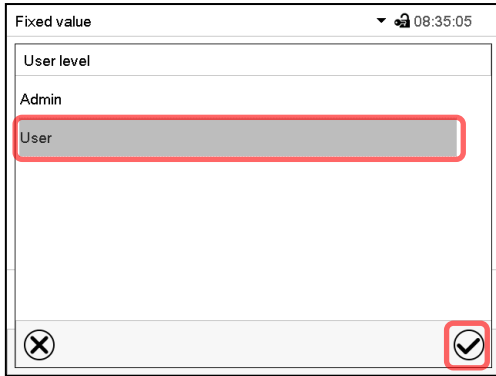

Selection of the authorization level
(example: view with "Admin" authorization)

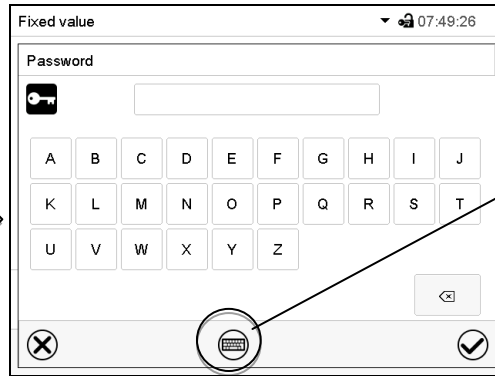

Enter desired password.

If desired, press the **Change keyboard** icon to access other entry windows.

In the "Keyboard switch" window you can select different keyboards to enter uppercase and lowercase letters, digits, and special characters. All types of characters can be combined within one single password.



Example: access the digit entry window

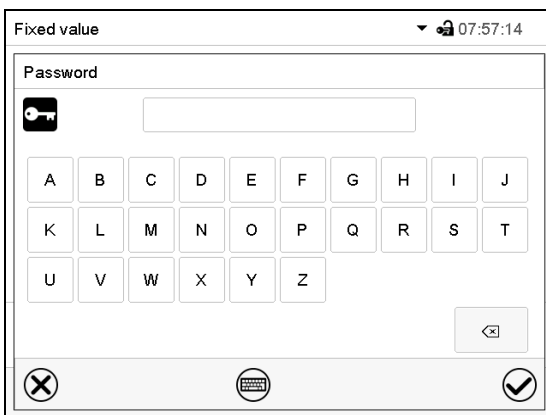

Entry of uppercase letters

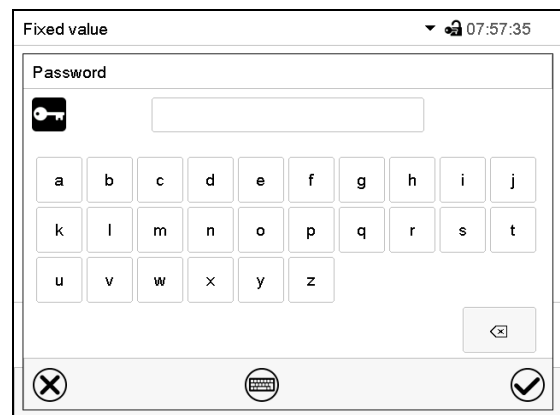

Entry of lowercase letters

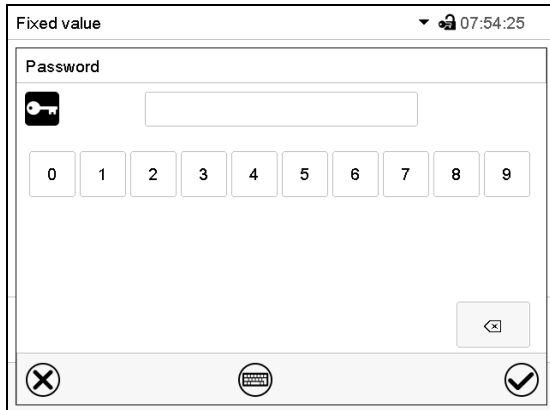

Entry of digits

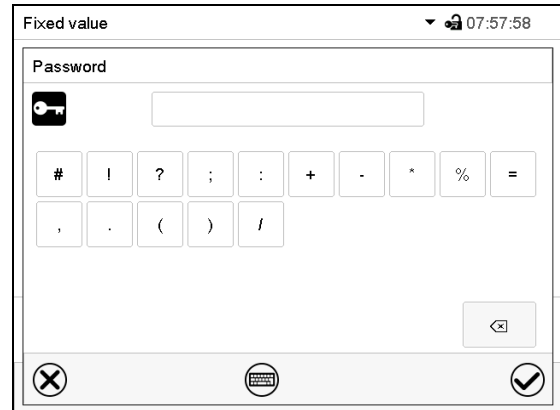

Entry of special characters

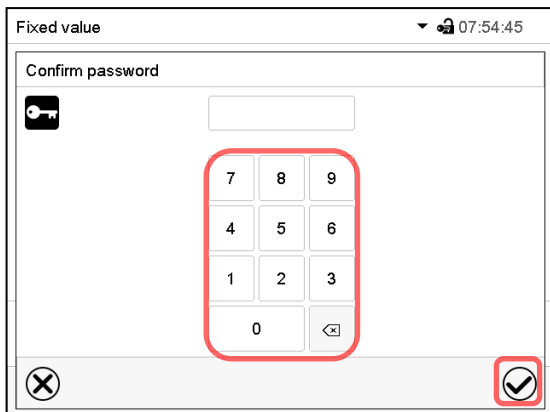

To confirm the password after the entry, repeat the entry and press the **Confirm** icon.

13.5.2 Deleting the password for an individual authorization level

A user logged-in with “Service” or “Admin” authorization can delete the passwords of his current level and of the next lower level(s). To do this no password is entered during a password change.

Path: **Main menu > User > Password**

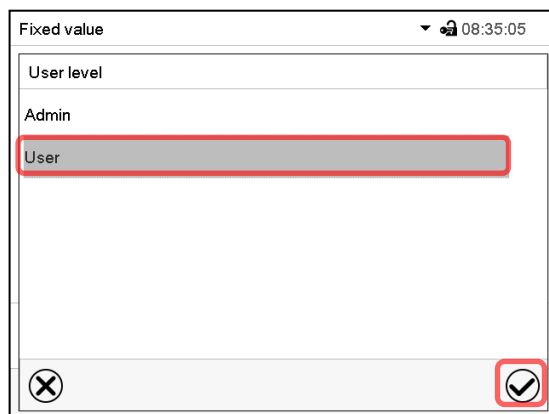
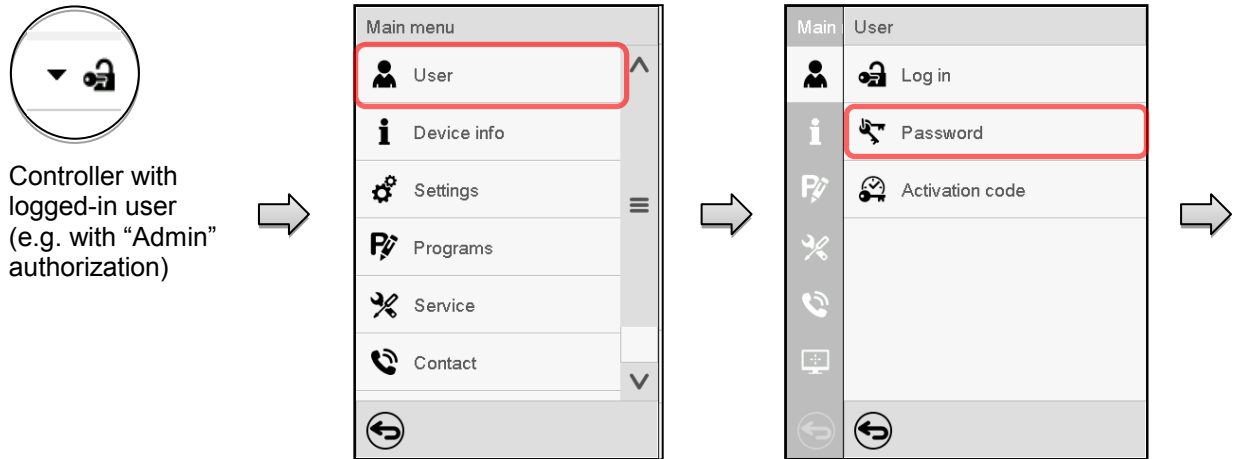

Select the authorization level for which the password shall be deleted.

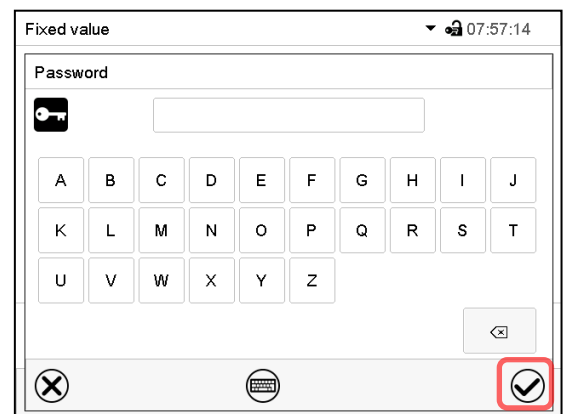

No entry in the “Password” screen. Press the **Confirm** icon.

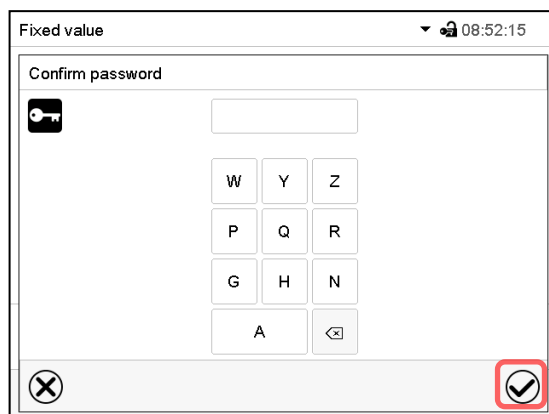

No entry in the “Confirm password” screen. Press the **Confirm** icon.

The password is deleted.

13.5.3 New password assignment for “service” or “admin” authorization level when the password function was deactivated

If the password protection for an authorization level has been deactivated, i.e., no password is assigned, no login for this level is possible. Therefore access to this authorization level is available without login.

If the password for the “Service” or “Admin” authorization has been deleted (chap. 13.5.2), a new password can be assigned for the current level and the next lower level(s) without user login.

Example: The password for the “Admin” authorization level was deleted, therefore every user without login has full access to the functions of the “Admin” authorization level. If access to this level shall become password protected again, the user can assign a new password for the “Admin” authorization level with the “Password” function.

Path: **Main menu > User > Password**

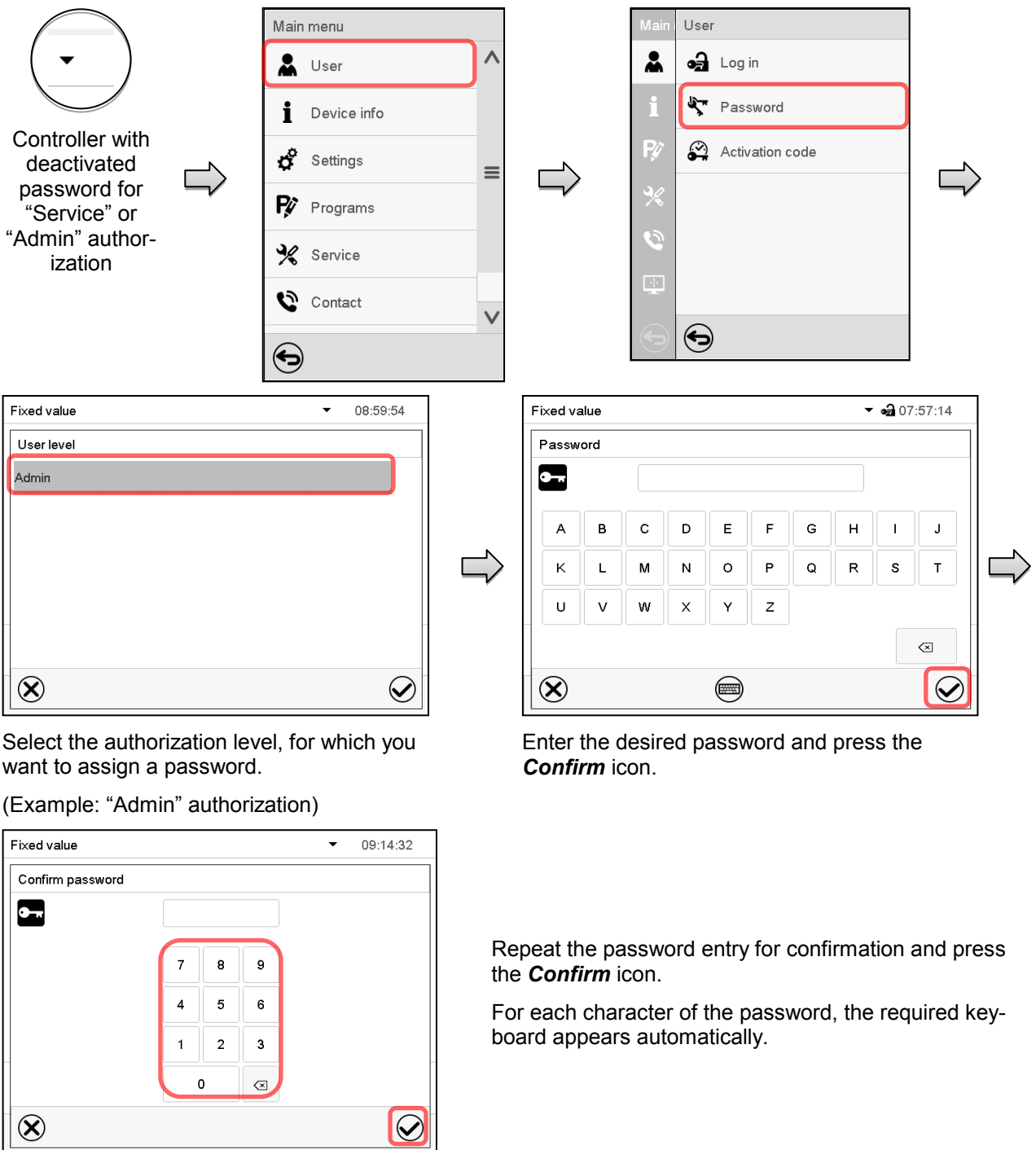

Select the authorization level, for which you want to assign a password.

Enter the desired password and press the **Confirm** icon.

(Example: “Admin” authorization)

Repeat the password entry for confirmation and press the **Confirm** icon.

For each character of the password, the required keyboard appears automatically.

13.6 Activation code

Certain functions of the controller can be unlocked with a previously generated activation code.

The activation code enables access to functions available only in the “Service” authorization level by users without a “Service” authorization. Such functions include e.g., adjustment or extended configurations.

The activation code is available in authorization levels.

Path: **Main menu > User > Activation code**

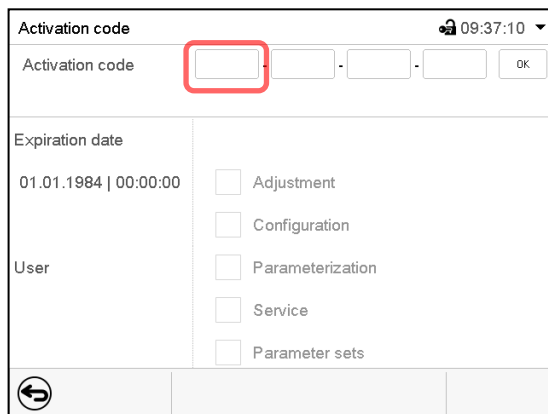
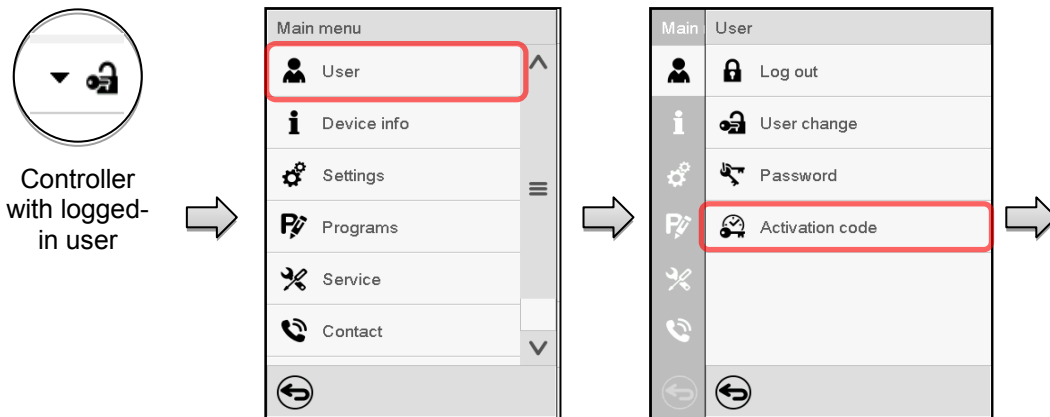

Activation code menu.

Select the first of the four entry fields.

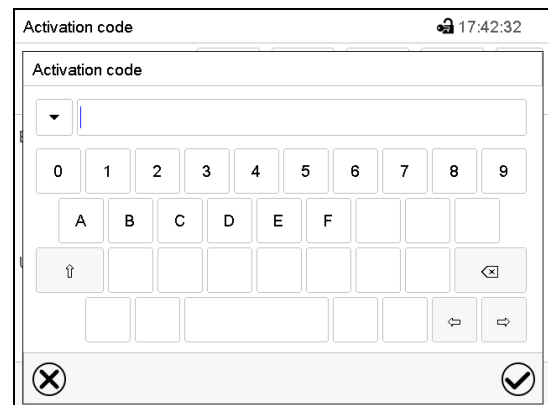

Activation code entry window.

Enter the first four characters of the activation code and press the **Confirm** icon.

Select the next of the four entry fields and proceed accordingly until the entire code has been entered.

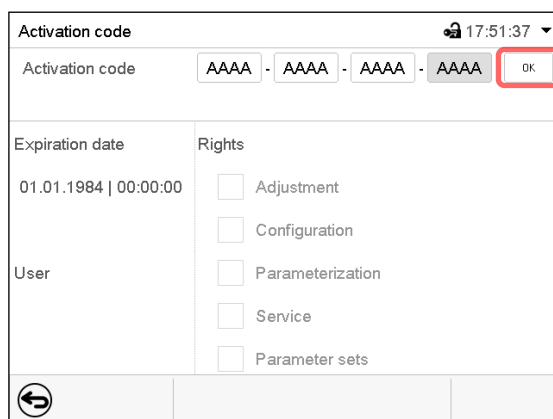

“Activation code” menu with entered code (sample view).

Press **OK** to take over the entry

The available functions are indicated by marked checkboxes.

Example: Extended configurations available.

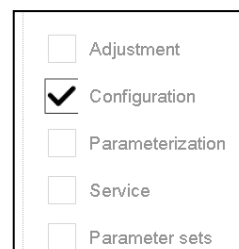

Under “Expiration date” the date of expiry of the code is displayed.

14. General controller settings

Most of the general settings can be accessed in the “Settings” submenu, which is available for users with “Service” or “Admin” authorization level. It serves to enter date and time, select the language for the controller menus and the desired temperature unit and to configure the controller’s communication functions.

14.1 Selecting the controller’s menu language

The MB2 program controller communicates by a menu guide using real words in German, English, French, Spanish, and Italian.

Path: **Main menu > Settings > Chamber**

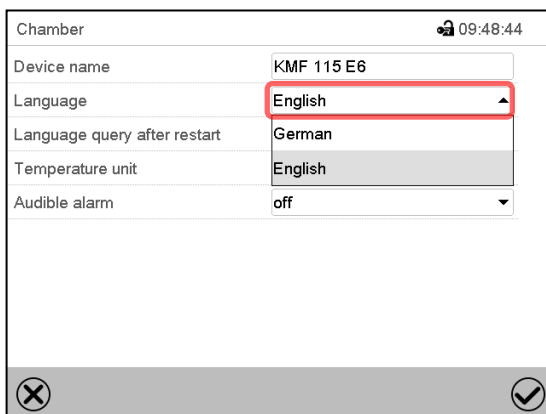

Chamber		09:48:44
Device name	KMF 115 E6	
Language	English	
Language query after restart	German	
Temperature unit	English	
Audible alarm	off	

“Chamber” submenu.

Select the desired language.

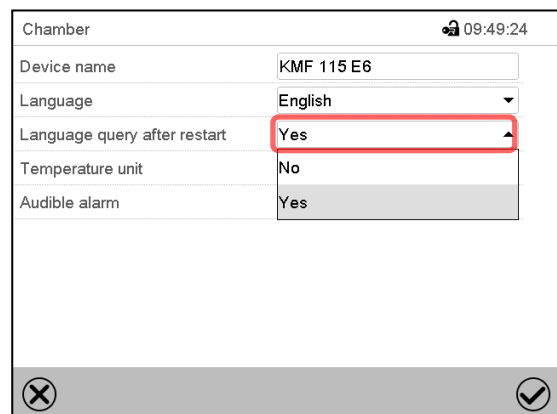

Chamber		09:49:24
Device name	KMF 115 E6	
Language	English	
Language query after restart	Yes	
Temperature unit	No	
Audible alarm	Yes	

“Chamber” submenu.

Select if there shall be a language query after restarting the chamber and press the **Confirm** icon.

14.2 Selecting the temperature unit

Following start-up of the chamber:

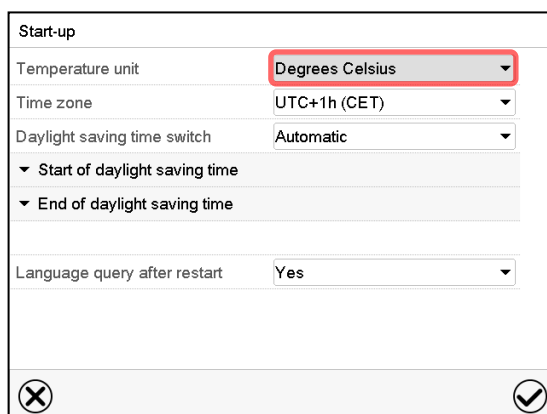

Start-up	
Temperature unit	Degrees Celsius
Time zone	UTC+1h (CET)
Daylight saving time switch	Automatic
Start of daylight saving time	
End of daylight saving time	
Language query after restart	Yes

Or later:

Path: **Main menu > Settings > Chamber**

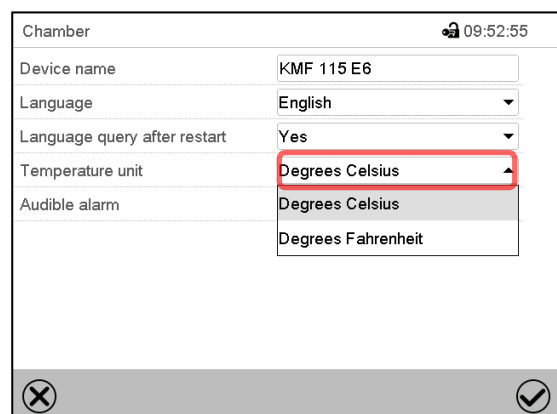

Chamber		09:52:55
Device name	KMF 115 E6	
Language	English	
Language query after restart	Yes	
Temperature unit	Degrees Celsius	
Audible alarm	Degrees Celsius Degrees Fahrenheit	

Select the desired temperature unit and press the **Confirm** icon.

Change of the temperature unit between °C and °F.

If the unit is changed, all values are converted accordingly

	C = degree Celsius	0 °C = 31°F	Conversion:
	F= degree Fahrenheit	100 °C = 212°F	[value in °F] = [value in °C] * 1,8 + 32

14.3 Setting date and time

Following start-up of the chamber after language selection:

Select the time zone and configure the daylight saving time switch.

Or later:

Path: **Main menu > Settings > Date and time**

“Date and time” submenu.

Select the field “Date / time”.



“Date / time” entry menu.

Enter date and time and press the **Confirm** icon.

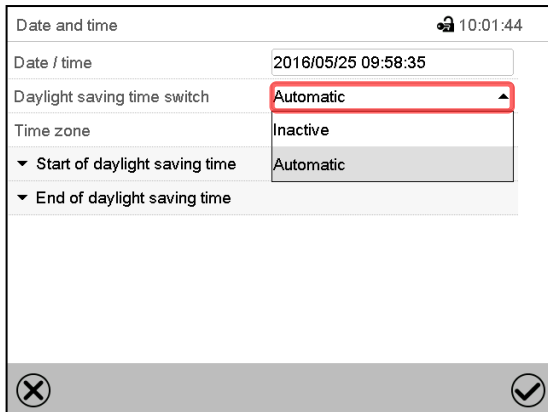

“Date and time” submenu.

In the field “Daylight saving time switch” select the desired setting “Automatic” or “Inactive”.

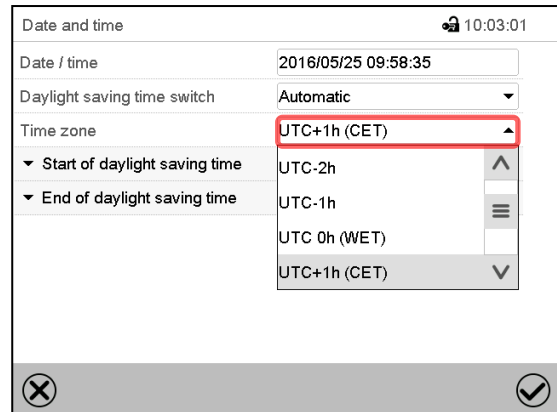

“Date and time” submenu.

Select the desired time zone and press the **Confirm** icon.

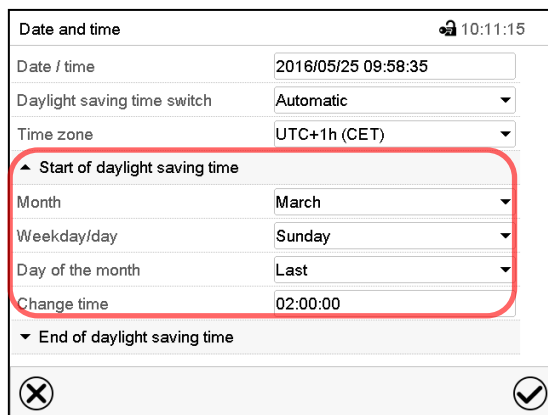

“Date and time” submenu.

Select the desired start of the daylight saving time.

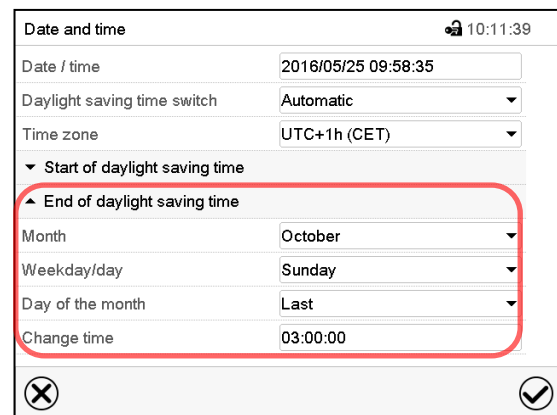

“Date and time” submenu.

Select the desired end of the daylight saving time and press the **Confirm** icon.

There are the following possibilities:

	Press the Confirm icon to take over the entries and exit the menu.
	Press the Close icon to exit the menu without taking over the entries.

14.4 Display configuration

14.4.1 Adapting the display parameters ()

This function serves to configure parameters like display brightness and operating times.

Path: **Main menu > Settings > Display > Display**

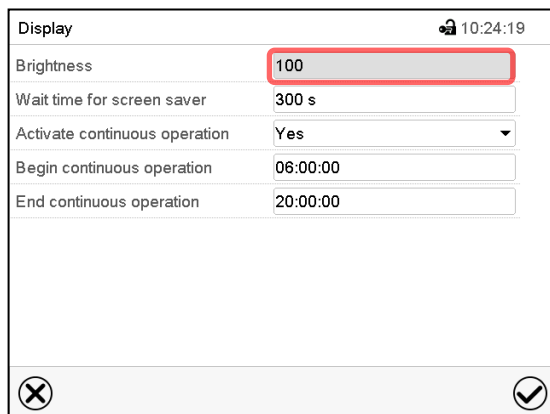

“Display” submenu.

Select the field “Brightness”.

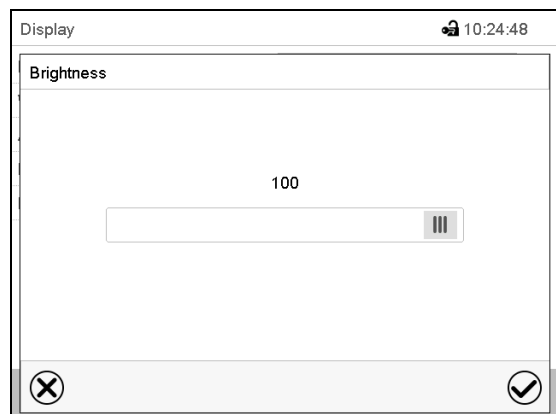

Move the grey slide to the left or right to define the brightness of the display

- left = darker (minimum value: 0)
- right = brighter (maximum value: 100)

Press the **Confirm** icon.

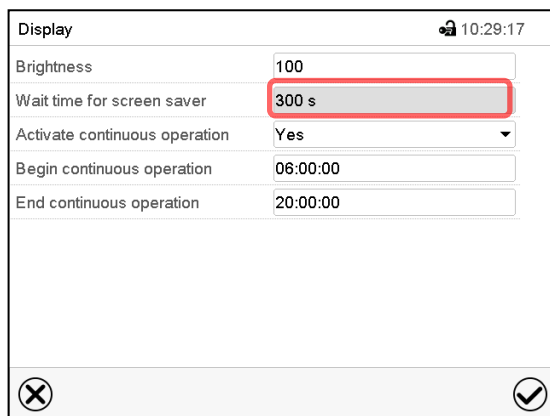

“Display” submenu.

Select the field “Wait time for screen saver”.

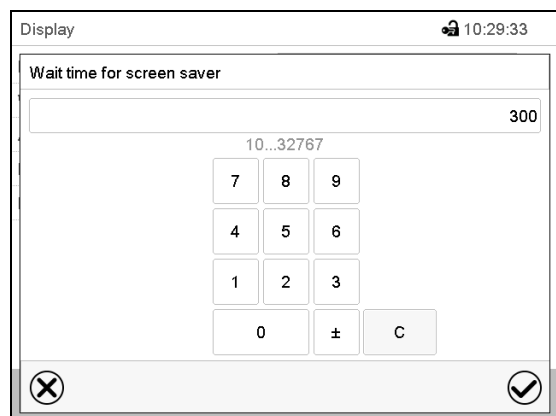

Entry menu “Wait time for screen saver”.

During the waiting time the display is off.

Enter the desired waiting time for the screen saver in seconds and press the **Confirm** icon.

Setting range: 10 sec up to 32767 sec.

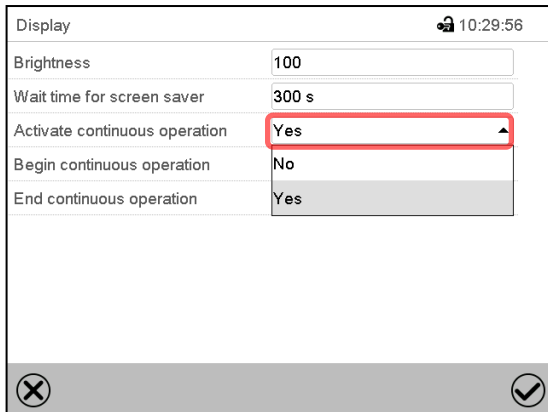

“Display” submenu.

In the field “Activate continuous operation” select the desired setting “Yes” or “No”.

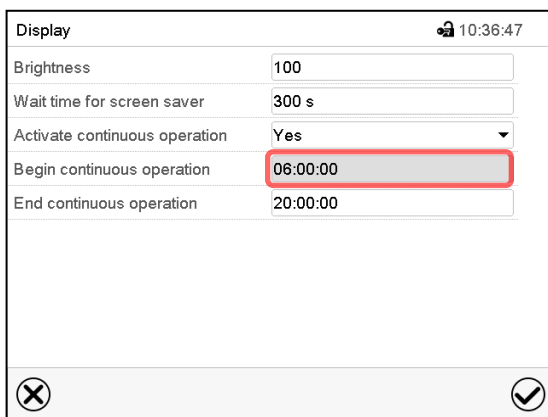

“Display” submenu.

Select the field “Begin continuous operation” (possible only if continuous operation is activated)

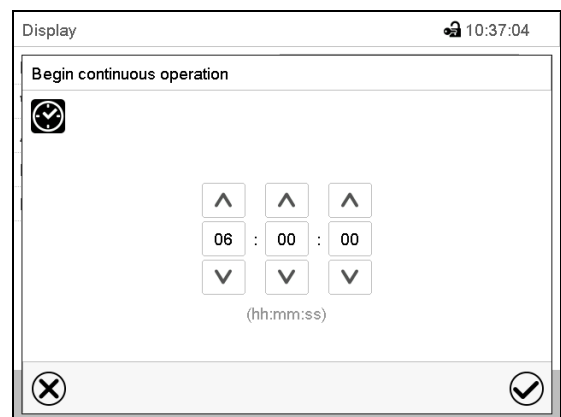

Entry menu “Begin continuous operation”.

Enter the time with the arrow keys and press the Confirm icon.

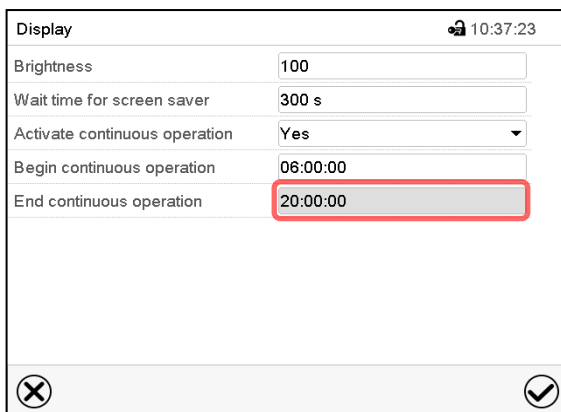

“Display” submenu.

Select the field “End continuous operation.” (only possible if continuous operation is activated)

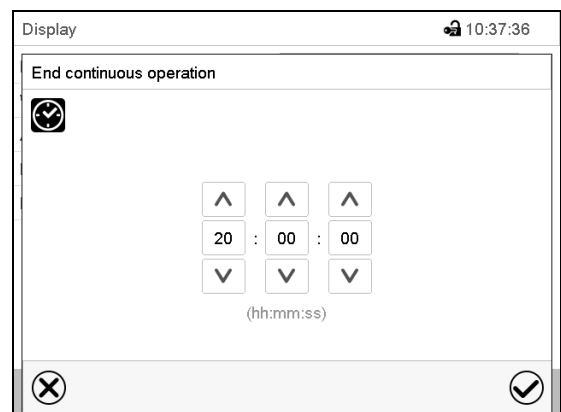

Entry menu „End continuous operation“.

Enter the time with the arrow keys and press the **Confirm** icon.

There are the following possibilities:

	Press the Confirm icon to take over the entries and exit the menu.
	Press the Close icon to exit the menu without taking over the entries.

14.4.2 Touchscreen calibration

This function serves to optimize the display for the user's individual angular perspective.

Path: **Main menu > Calibrate touchscreen**

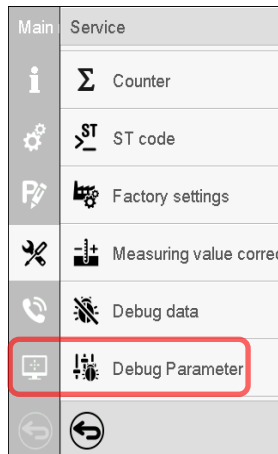
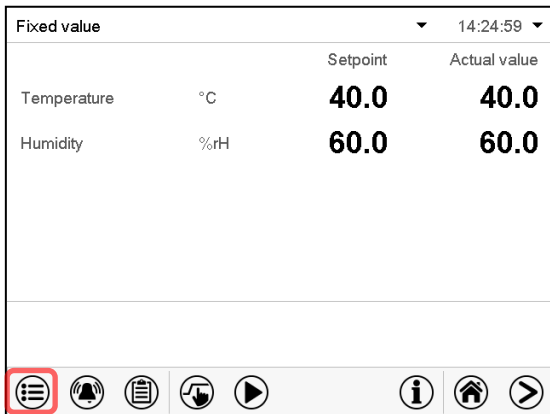

Normal display.

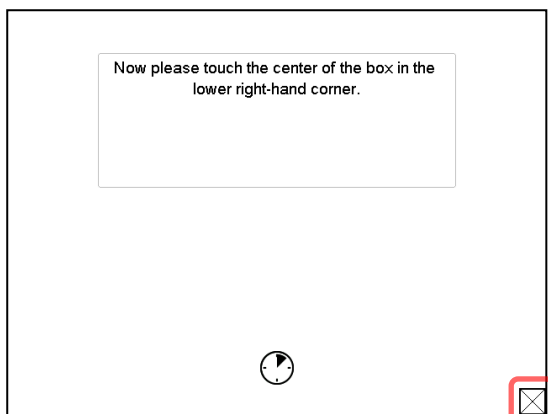
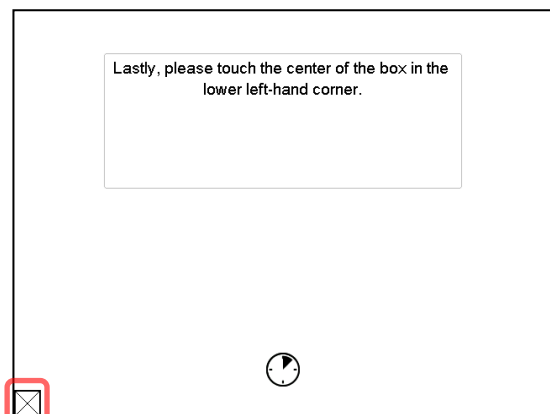
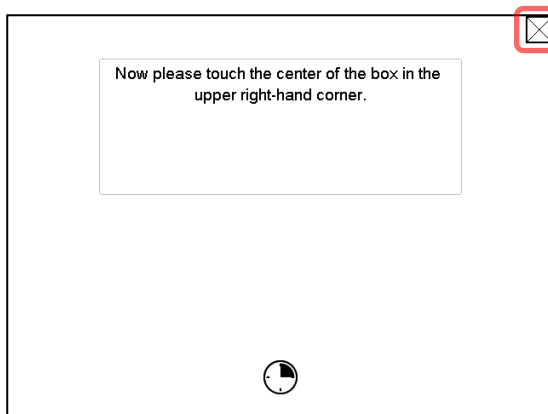
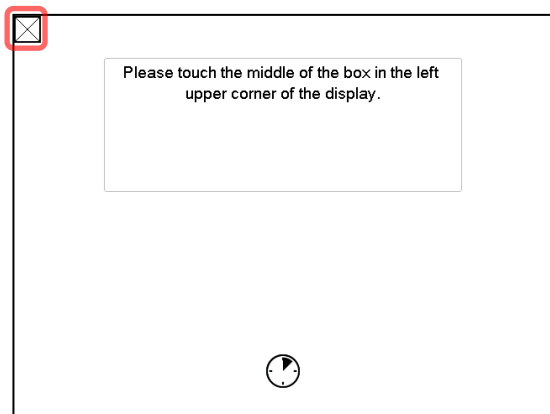

Follow the instructions on the display.

You need to touch all four corners of the touchscreen to calibrate it. Appropriate boxes appear successively in each corner.

	<p>The clock icon shows how much time there is left to touch the currently activated box. If the box is not touched within this period, calibration is aborted and the display changes to Normal display.</p>
--	---

After completing the calibration, i.e., touching all four boxes, the display changes to Normal display.

14.5 Network and communication

For these settings at least the “Admin” authorization level is required.

14.5.1 Serial interfaces

The chamber is optionally equipped with a serial RS485 interface.

This menu allows to configure the communication parameters of the RS485 interface.

The device address is required to recognize chambers with this interface type in a network, e.g. when connecting it to the optional communication software BINDER APT-COM™ 3 DataControlSystem (chap. 19.1). In this case do not change the other parameters.

Path: **Main menu > Settings > Serial interfaces**

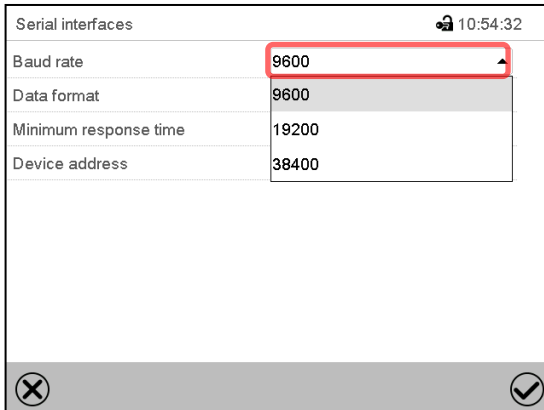

Serial interfaces 10:54:32

Baud rate	9600
Data format	9600
Minimum response time	19200
Device address	38400

“Serial interfaces” submenu.

Select the desired setting in the field “Baud rate”.

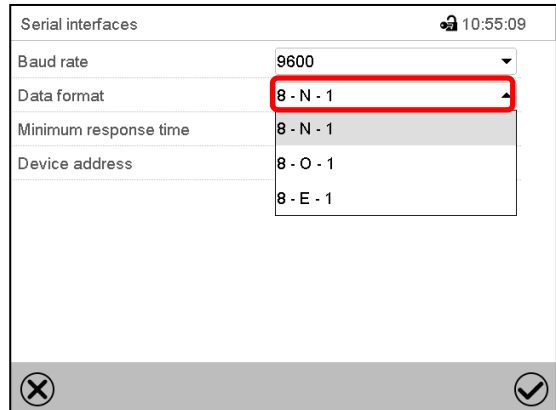



Serial interfaces 10:55:09

Baud rate	9600
Data format	8 - N - 1
Minimum response time	8 - N - 1
Device address	8 - O - 1
	8 - E - 1

“Serial interfaces” submenu.

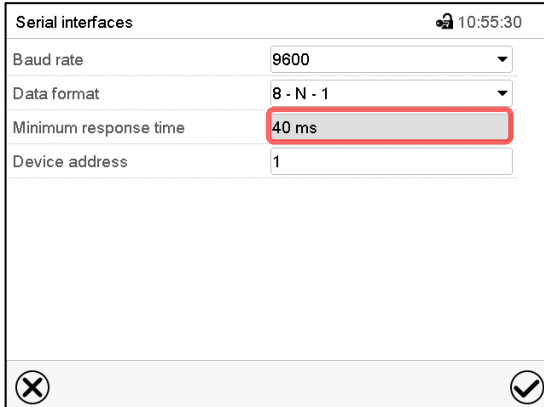
Select the desired setting in the field “Data format”.





Serial interfaces 10:55:30

Baud rate	9600
Data format	8 - N - 1
Minimum response time	40 ms
Device address	1

“Serial interfaces” submenu.

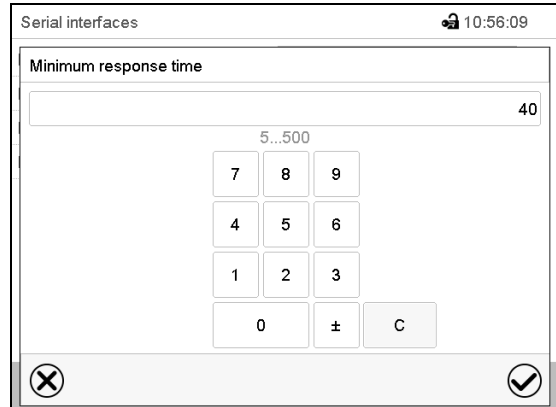
Select the field “Minimum response time”

Serial interfaces 10:56:09

Minimum response time

40

5...500

7	8	9
4	5	6
1	2	3
0	±	C

“Minimum response time” entry menu.

Enter the desired minimum response time and press the **Confirm** icon.



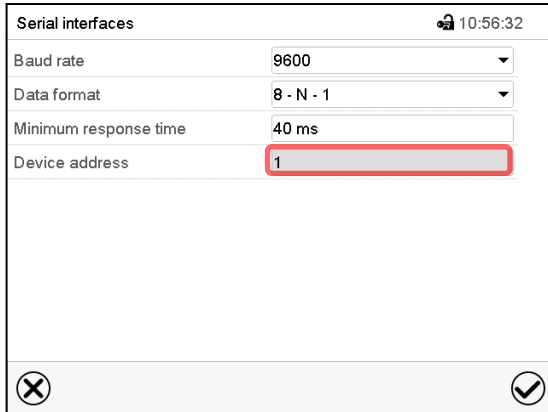

“Serial interfaces” submenu.
Select the field “Device address”.

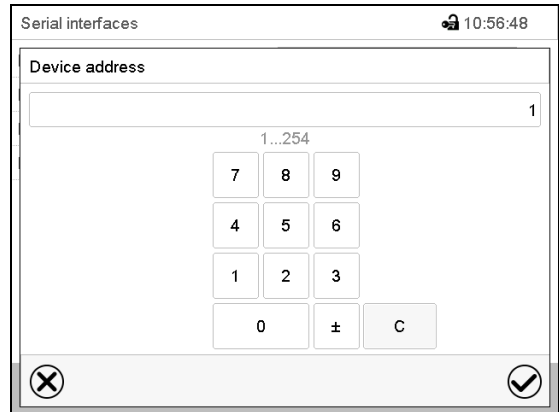

“Device address” entry menu
Enter the device address and press the **Confirm** icon.
Factory setting: “1”.



14.5.2 Ethernet

Path: **Main menu > Settings > Ethernet**

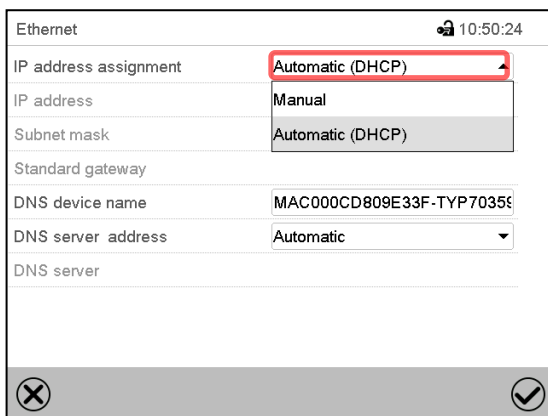

“Ethernet” submenu.

In the field “IP address assignment” select the desired setting “Automatic (DHCP)” or “Manual”.

With selection „Manual“ you can enter the IP-address, the subnet mask and the standard gateway manually.

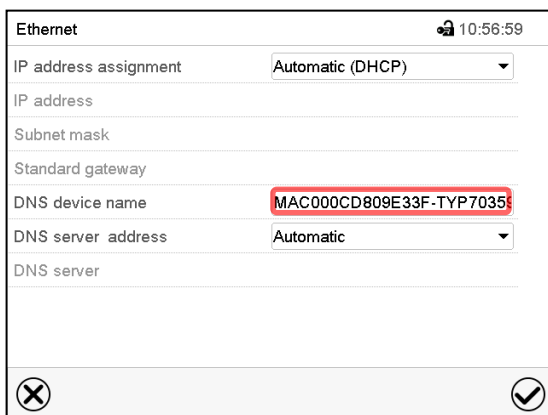
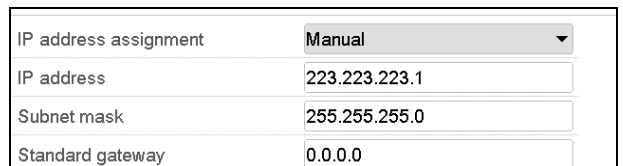

“Ethernet” submenu.
Select “DNS device name”.

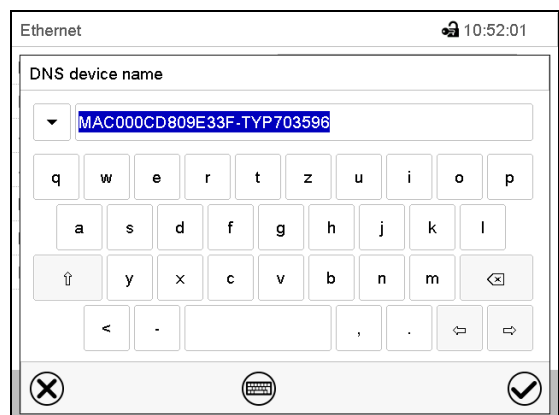

“DNS device name” entry menu.
Enter the DNS device name and press the **Confirm** icon.



Ethernet 🔒 10:52:41	
IP address assignment	Automatic (DHCP)
IP address	
Subnet mask	
Standard gateway	Manual
DNS device name	Automatic
DNS server address	Automatic
DNS server	

“Ethernet” submenu.

In the field “DNS server address” select the desired setting “Automatic” or “Manual”.

With selection „Manual“ you can enter the DNS server address manually.

DNS server address	Manual
DNS server	0.0.0.0

14.5.3 Web server

This controller menu serves to configure the web server. Then you can enter the chamber’s IP-address in the Internet. The IP address is available via *Chamber information > Ethernet*. The BINDER web server opens. Enter the user name and password which have been assigned for the web server in the controller menu. This enables online access to the controller display, to see e.g., the event list or error messages. In this view no settings can be changed.

Path: **Main menu > Settings > Web server**

Web server 🔒 11:08:07	
Password active	Yes
User name	No
Password	Yes
Automatic log out after	0 Min

“Webserver” submenu.

In the field “Password active” select the desired setting “Yes” or “No” and press the **Confirm** icon.

Web server 🔒 11:08:32	
Password active	Yes
User name	admin
Password	1234
Automatic log out after	0 Min

Submenu “Web server”.

Select the field “User name”.



Web server 🔒 11:08:51	
User name	
admin	

“User name” entry menu.

Enter the desired user name and press the **Confirm** icon.

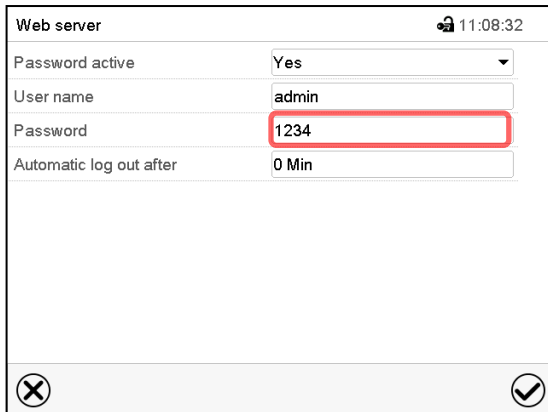

Web server 11:08:32

Password active Yes

User name admin

Password 1234

Automatic log out after 0 Min

Submenu "Web server".
Select the field "Password".

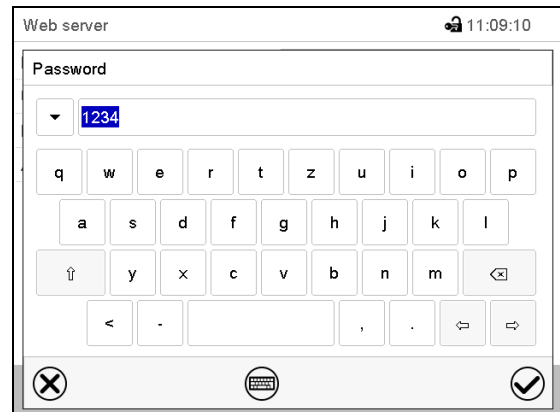
Web server 11:09:10

Password

1234

q w e r t z u i o p

a s d f g h j k l

↑ y x c v b n m

< - , . ↵ ⇌

"Password" entry menu (example).
Enter the desired password and press the **Confirm** icon.

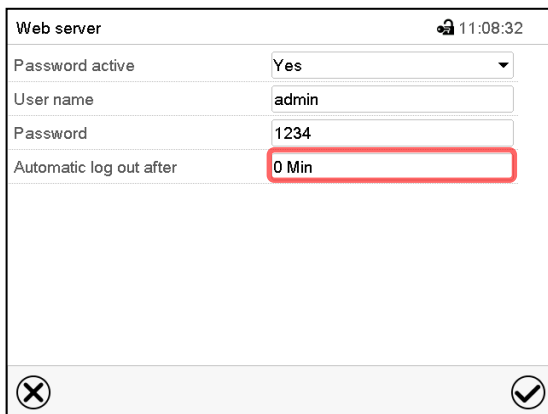

Web server 11:08:32

Password active Yes

User name admin

Password 1234

Automatic log out after 0 Min

Submenu "Web server".
Select the field "Automatic log out after".

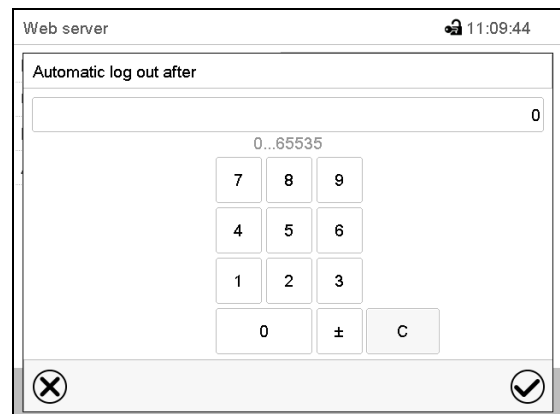
Web server 11:09:44

Automatic log out after

0

0...65535

7 8 9

4 5 6

1 2 3

0 ± C

"Automatic log out after" entry menu.
Enter the time in minutes after which the web-server shall log out automatically and press the **Confirm** icon.
Setting range: 0 min to 65535 min.

14.5.4 E-Mail

As soon as an alarm was triggered, an e-mail is sent to the configured e-mail address.

Path: **Main menu > Settings > Email**

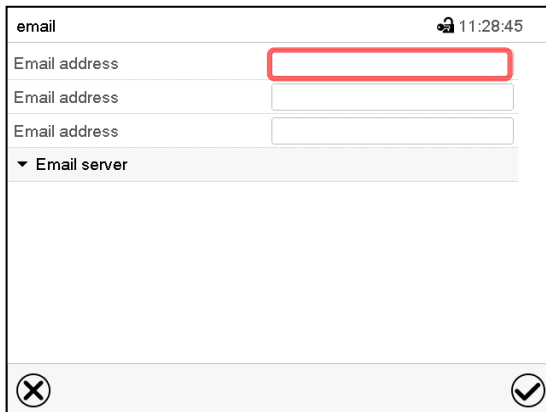

“Email” submenu.

Select the field of the e-mail address to be entered.

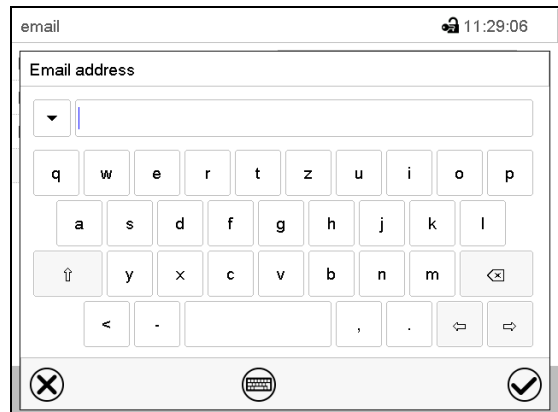

“Email address” entry menu.

Enter the e-mail address. You can use the **Keyboard change** icon for entry.

Press the **Confirm** icon.

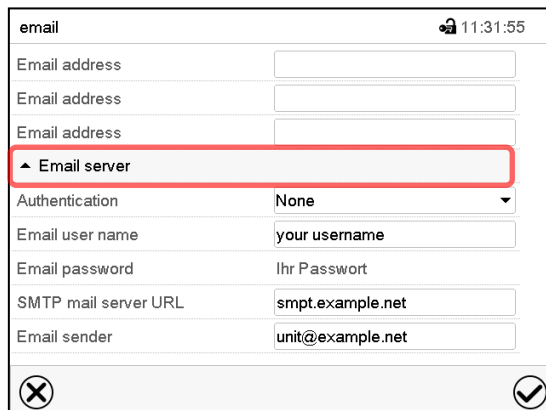

Select the field “Email server” to access the server settings

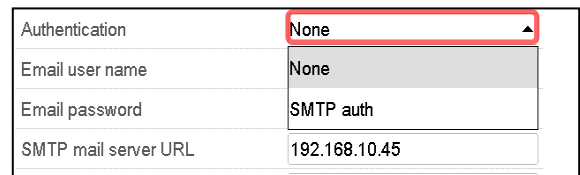

In the field “Authentication” select the desired setting “None” or “SMTP” auth”.

With the setting “SMTP auth”, you can enter a password under “Email password”.

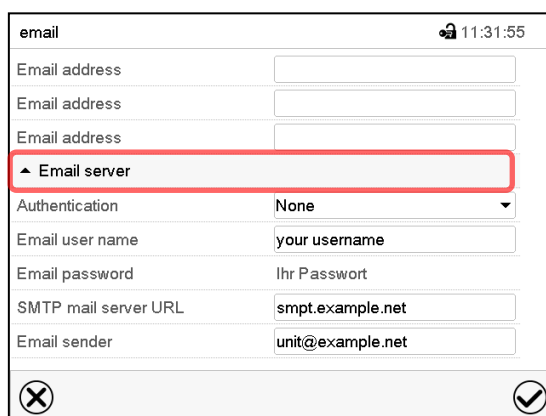

Select the field “Email user name”.

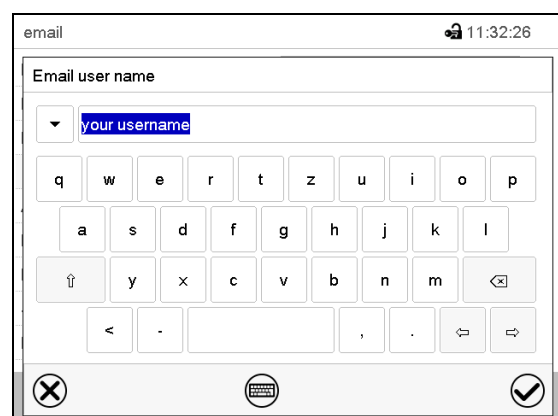

Enter the desired user name and press the **Confirm** icon.

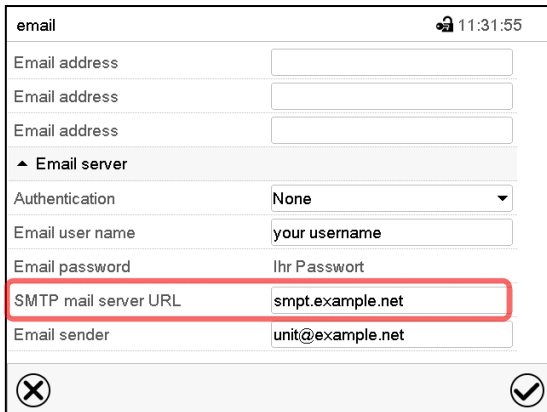

email 11:31:55

Email address

Email address

Email address

▲ Email server

Authentication None

Email user name your username

Email password Ihr Passwort

SMTP mail server URL **smpt.example.net**

Email sender unit@example.net

Close Confirm

Select the field "SMTP mail server URL".



email 11:32:48

SMTP mail server URL

smpt.example.net

q w e r t z u i o p

a s d f g h j k l

↑ y x c v b n m

< . , . ↵ ↶

Close Keyboard Confirm

Enter the SMPT mail server URL and press the **Confirm** icon.

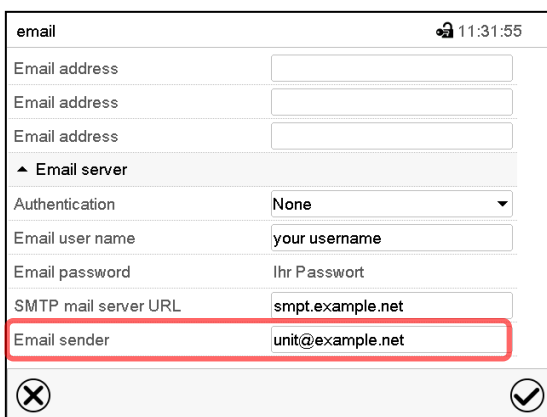

email 11:31:55

Email address

Email address

Email address

▲ Email server

Authentication None

Email user name your username

Email password Ihr Passwort

SMTP mail server URL smpt.example.net

Email sender **unit@example.net**

Close Confirm

Select the field "Email sender".

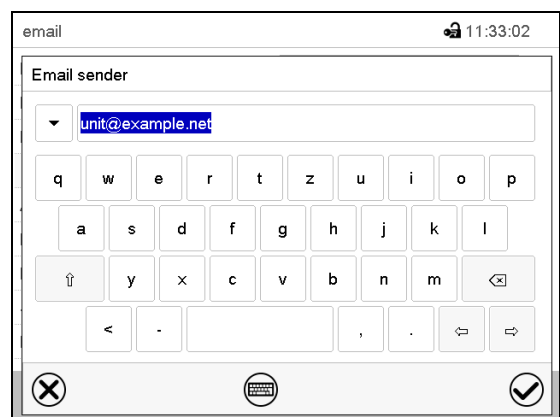
email 11:33:02

Email sender

unit@example.net

q w e r t z u i o p

a s d f g h j k l



↑ y x c v b n m

< . , . ↵ ↶

Close Keyboard Confirm

Enter the desired Email sender and press the **Confirm** icon.

There are the following possibilities:

	Press the Confirm icon to take over the entries and exit the menu.
	Press the Close icon to exit the menu without taking over the entries.

14.6 Data import / export via USB medium

When you insert a USB-stick, the “USB” menu opens.

Depending on the user’s authorization level, different functions (highlighted in black) are available for the logged-in user.

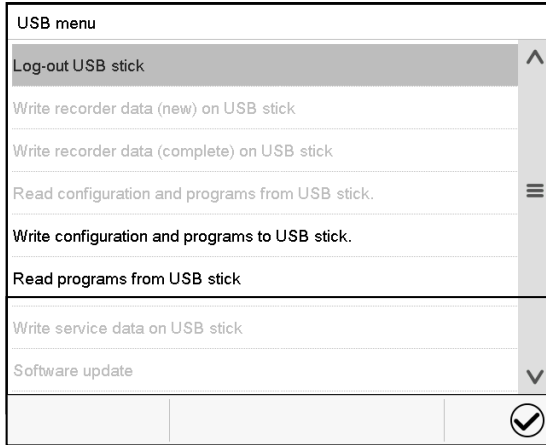

Available functions with “User” authorization level

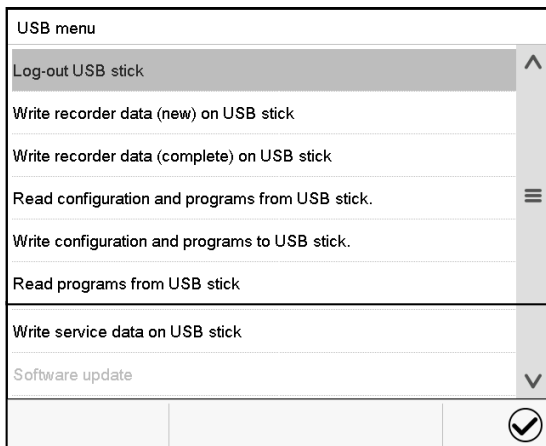

Available functions with “Admin” authorization level

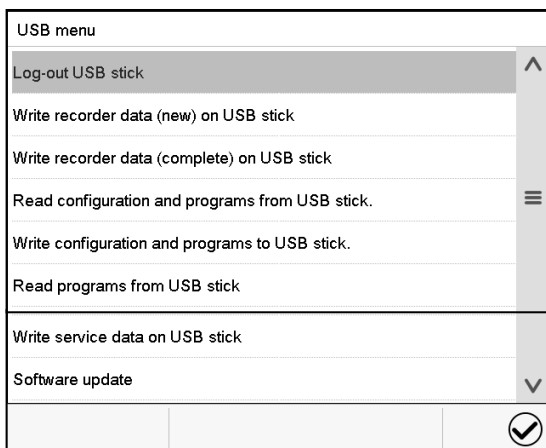

Available functions with “Service” authorization level

15. General information

15.1 Service contact page

Path: *Main menu* > *Contact*

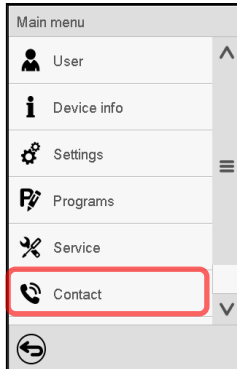

15.2 Current operating parameters

Fixed value		Setpoint	Actual value
Temperature	°C	40.0	40.0
Humidity	%rH	80.0	80.0

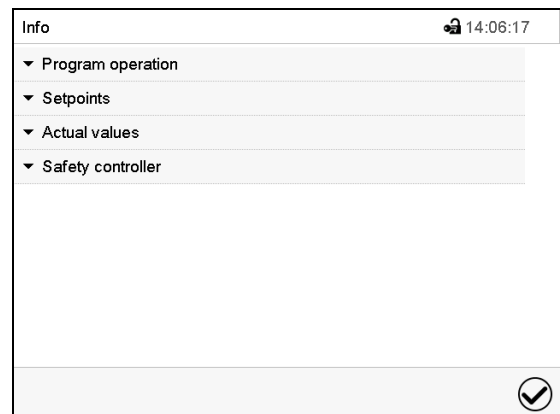

Normal display.

Press the **Information** icon.

“Info” menu.

Select the desired information.

Info	
▲ Program operation	
Program type	Time program
Program name	program 1
Program info	
Program start	08.06.2016 07:34:57
Program duration	87:00:00
Rem. program runtime	87:00:00
Program end	11.06.2016 22:35:49
Section number	1 / 87
Section duration	00:00:00
Remaining section time	01:00:00
▼ Setpoints	
▼ Actual values	
▼ Safety controller	

Info	
▼ Program operation	
▲ Setpoints	
Temperature	40.0 °C
Humidity	80.0 %rH
Fan	100.0 %
Operation lines	0000000000000000
▼ Actual values	
▼ Safety controller	

Selection “Setpoints”.

Information on the entered setpoints and operation lines.

Selection “Program operation”.

Information on a currently running program.

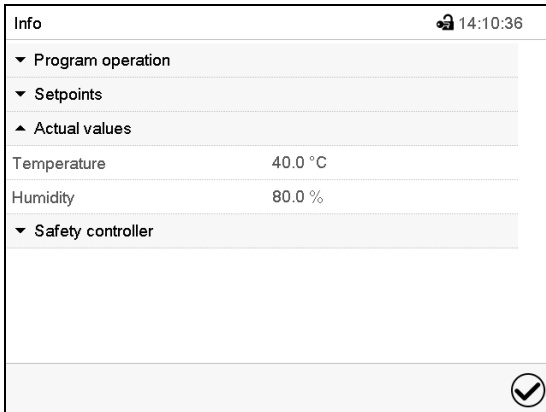

Selection "Actual values".
Information on the current actual values.

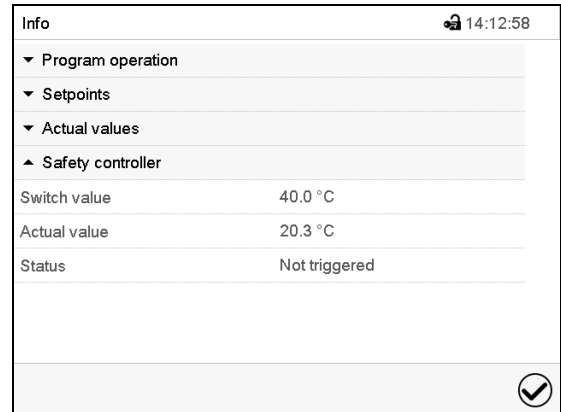

Selection "Safety controller".
Information on the safety controller.

15.3 Event list

	Press the Event list icon to access the event list from Normal display.
	Press the Back icon to return from every setting menu to Normal display.
	Press the Update icon to update the event list.

The "Event list" displays status information and errors of the current day. It enables to view the last 100 events or defective conditions of the chamber.

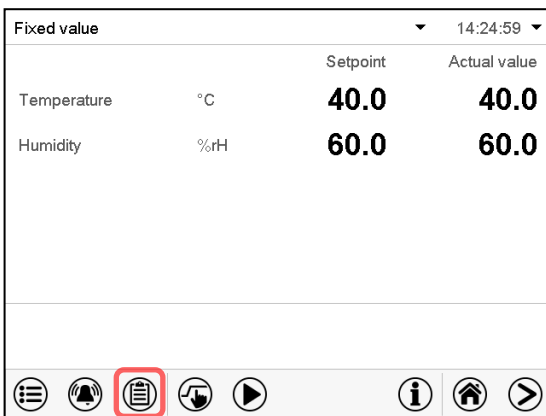

Normal display.
Press the **Event list** icon.

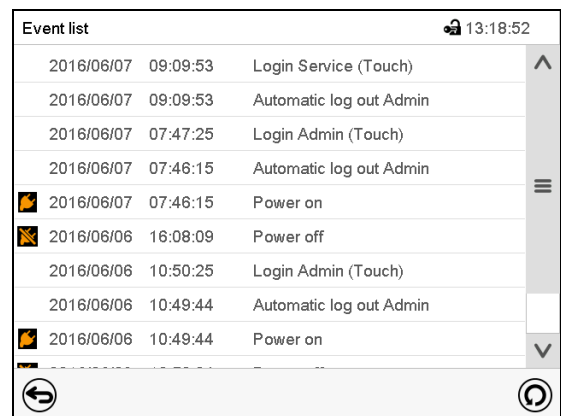

15.4 Technical chamber information

Path: **Main menu > Device info**

<table border="1"> <tr> <td>Main</td> <td>Device info</td> </tr> <tr> <td></td> <td> General</td> </tr> <tr> <td></td> <td>v1.x Versions</td> </tr> <tr> <td></td> <td> In-/Outputs</td> </tr> <tr> <td></td> <td> Modbus inputs</td> </tr> <tr> <td></td> <td> Ethernet</td> </tr> <tr> <td></td> <td></td> </tr> <tr> <td></td> <td></td> </tr> </table>	Main	Device info		General		v1.x Versions		In-/Outputs		Modbus inputs		Ethernet					Chamber name and setup	
	Main	Device info																
		General																
		v1.x Versions																
		In-/Outputs																
		Modbus inputs																
		Ethernet																
Versions of CPU, I/O module and safety controller	for BINDER Service																	
Information on digital and analog inputs and outputs and phase angle outputs	for BINDER Service																	
Information on modbus analog and digital inputs	for BINDER Service																	
Information on Ethernet connection, MAC address display	chap. 14.5.2																	
Back to main menu																		

Ethernet		🔒 13:49:56
Ethernet	Yes	▲
MAC address	00-0C-D8-09-E3-3F	
IP address	192.168.14.87	
Subnet mask	255.255.255.0	
Standard gateway	192.168.14.1	☰
DNS server	192.168.10.5	
DNS device name	MAC000CD809E33F-TYP703596	▼
		🏠



“Ethernet” submenu (example).



16. Chart recorder display

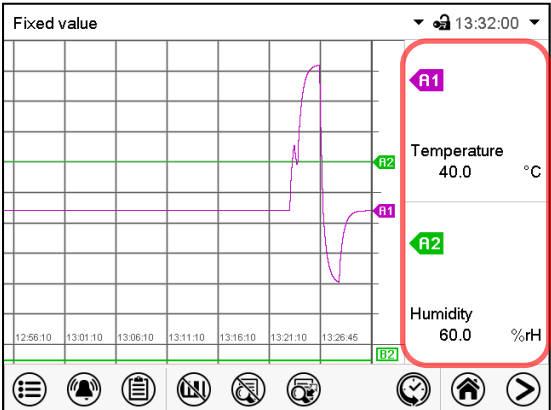

This view offers graphic representation of the measurement course. Data representation imitates a chart recorder and allows recalling any set of measured data at any point of time taken from the recorded period.

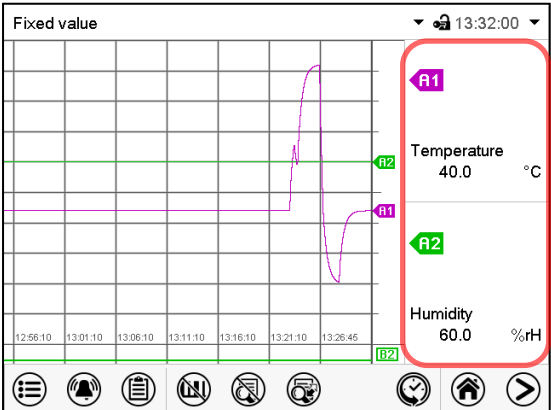

16.1 Views

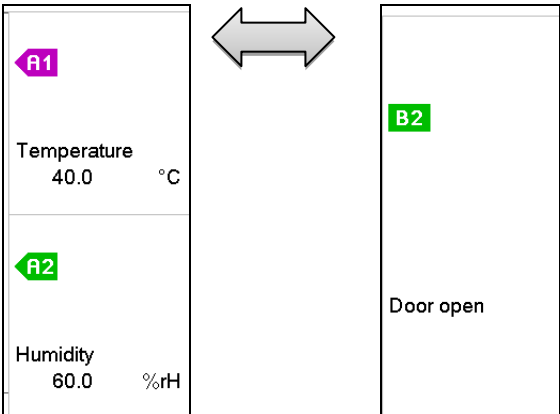

 Press the **Change view** icon to access the pen recorder display.

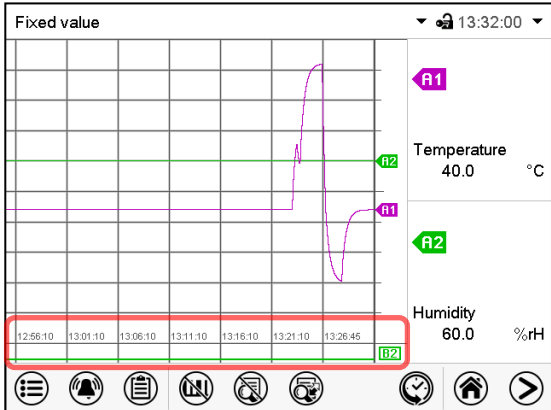

 →   Show legend on the right side of the display.

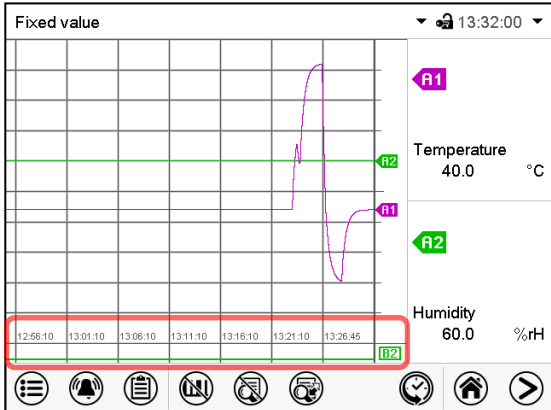

  Hide legend.

 →   Switch between legend pages.

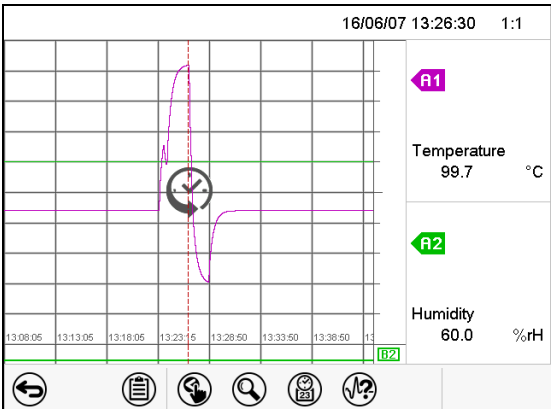
 →   Show the indication "Door open" (B2).

  Hide the indication "Door open"

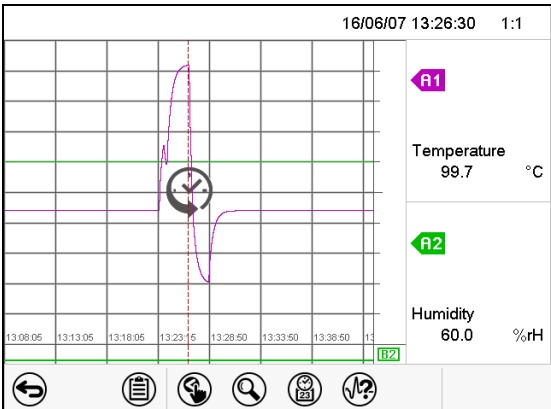
 →   Pause pen recorder. Data recording continues.

  Move the central red line by tapping and holding to the desired position.

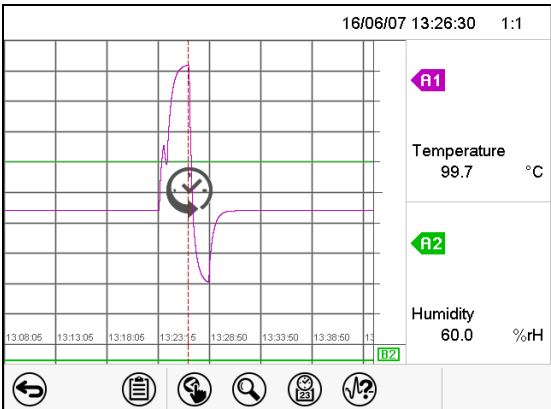
 The legend at the right side shows the values of the current line position.

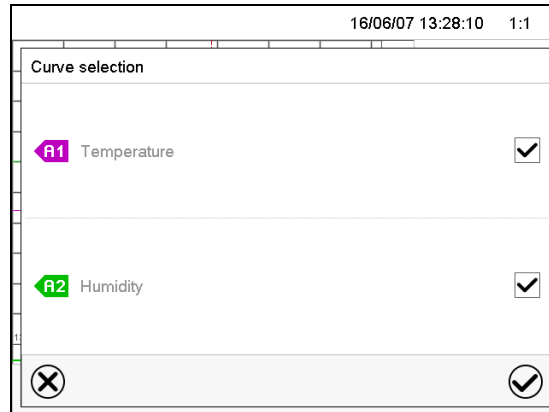

“Curve selection” submenu.

Select the curves to be displayed by checking the checkbox of the corresponding parameter.

Press the **Confirm** icon

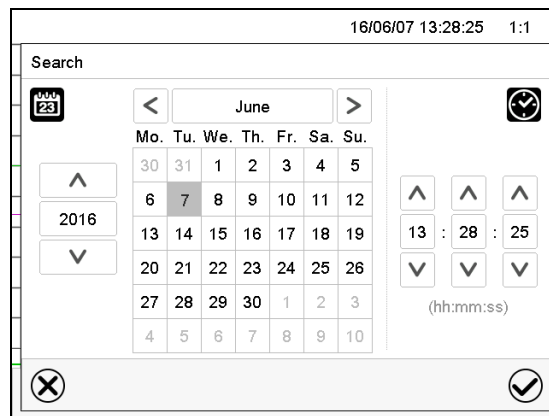

“Search” submenu.

Enter date and time of the required instant and press the **Confirm** icon

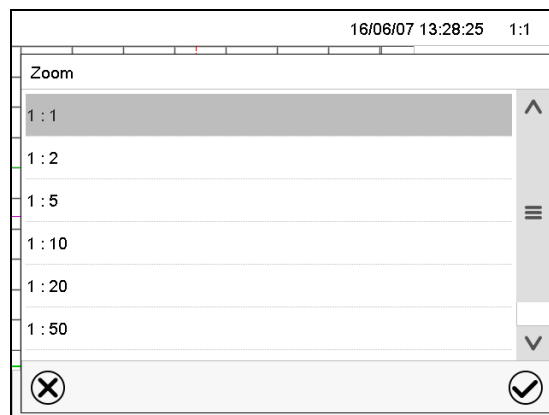

“Zoom” submenu.

Select the zoom factor and press the **Confirm** icon

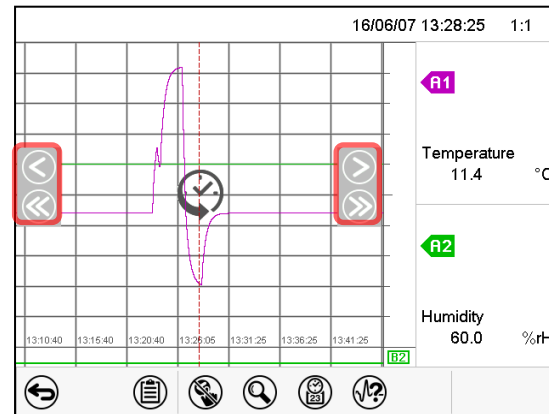

Arrow keys are shown on the left and on the right. Use them to move along the timeline.



Hide arrow keys.

16.2 Setting the parameters

This menu allows setting the storage interval, the type of values to be shown and the scaling of the temperature and humidity charts.

Path: **Main menu > Settings > Measurement chart**

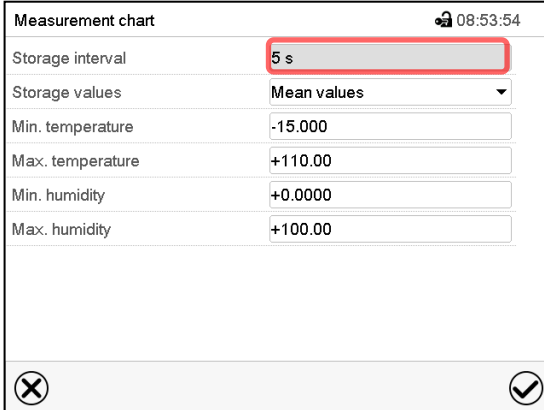

Measurement chart 08:53:54

Storage interval	5 s
Storage values	Mean values
Min. temperature	-15.000
Max. temperature	+110.00
Min. humidity	+0.0000
Max. humidity	+100.00

“Measurement chart” submenu.

Select the field “Storage interval”.

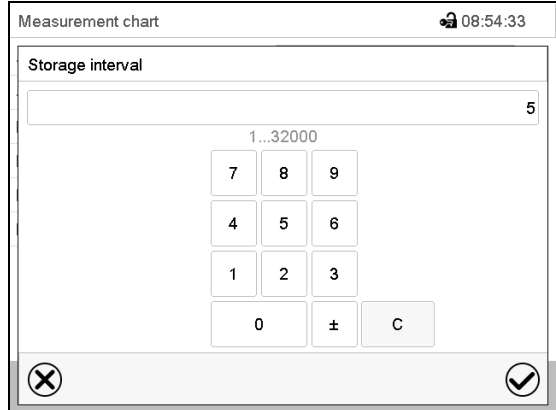
Measurement chart 08:54:33

Storage interval

1...32000

5

7	8	9
4	5	6
1	2	3
0	±	C

“Storage interval” entry menu.

Enter the desired storage interval and press the **Confirm** icon

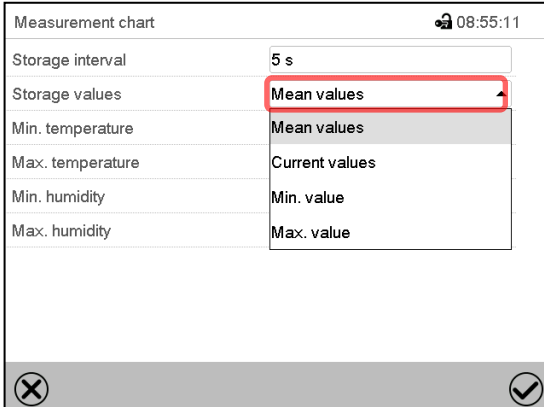

Measurement chart 08:55:11

Storage interval	5 s
Storage values	Mean values
Min. temperature	Mean values
Max. temperature	Current values
Min. humidity	Min. value
Max. humidity	Max. value

“Measurement chart” submenu.

In the field “Storage values” select the desired value type to be displayed.

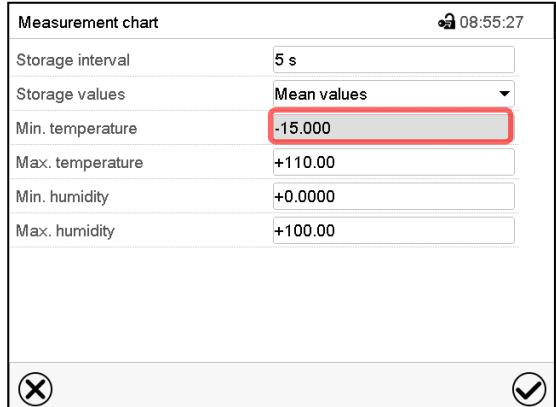

Measurement chart 08:55:27

Storage interval	5 s
Storage values	Mean values
Min. temperature	-15.000
Max. temperature	+110.00
Min. humidity	+0.0000
Max. humidity	+100.00

“Measurement chart” submenu.

For scaling the representation select the desired temperature or humidity value.

Temperature display range: -20 °C up to 110 °C

Humidity display range: 0% r.H. up to 100% r.H.



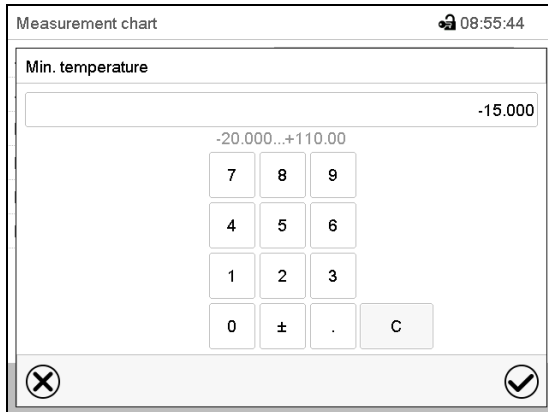

Example: “Min. temperature” entry menu.

Enter the desired value and press the **Confirm** icon.

The available presentation depends on the pre-selected storage rate. Factory setting: 60 seconds. This means the higher the storage rate, the more precisely but shorter the data representation will be.

	CAUTION
	<p>Setting the storage rate or rescaling (minimum and/or maximum) clears the measured-value memory.</p> <p>Danger of information loss.</p> <p>➤ Change the storage rate or scaling ONLY if the previously registered data is no longer needed.</p>

17. Humidification / dehumidification system

The chamber is equipped with a capacitive humidity sensor. This results in a control accuracy of up to $\pm 3\%$ r.H. of the set point. The temperature-humidity diagrams (Figure 19) show the possible working ranges for humidity.

- In the “setpoints” menu you can turn humidity control (humidification and dehumidification) on or off with the setting “Control on/off” (chap. 6.3).

With humidity control turned off, the humidification module cools down. After activation it will take up to 20 minutes until the humidification function is fully available again. This setting is required when operating the chamber without a water connection in order to avoid humidity alarms.

- Operation line “Humidity off” serves to turn off the humidification / dehumidification system in Fixed value operation (chap. 7.3, time program operation (chap. 9.7.3) and week program operation (chap. 10.6.7). This allows configuring the disconnection for individual program sections.

When the humidification / dehumidification system is turned off via operation line it remain on standby (filled and heated). Therefore it is immediately available after turning on.



The preset temperature and humidity values should be situated within the optimum range (hatched range in Figure 19). Only within this area will the chamber not be exposed to excessive moisture due to condensation.

In the short-term set points outside the optimum range can also be targeted. The control accuracies of $\pm 3\%$ r.H., however, cannot be guaranteed in this case.

KMF: When operating the chamber with activated humidity, humidity control turns off automatically at temperature set-points below $0\text{ }^{\circ}\text{C}$ / $32\text{ }^{\circ}\text{F}$ or above $95\text{ }^{\circ}\text{C}$ / $203\text{ }^{\circ}\text{F}$. The information icon **Humidity off** is displayed in the screen header in Normal display. When the temperature setpoint is set back to the range from $0\text{ }^{\circ}\text{C}$ / $32\text{ }^{\circ}\text{F}$ to $95\text{ }^{\circ}\text{C}$ / $203\text{ }^{\circ}\text{F}$, humidity control turns on again and the information icon **Humidity off** disappears.

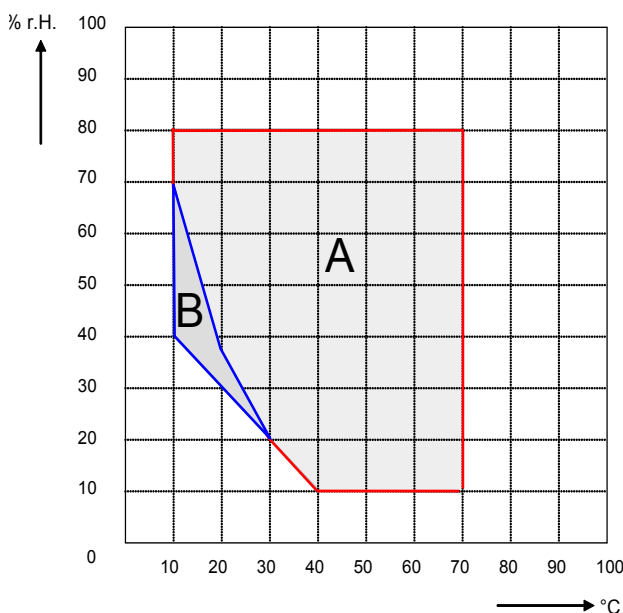

KBF temperature-humidity diagram

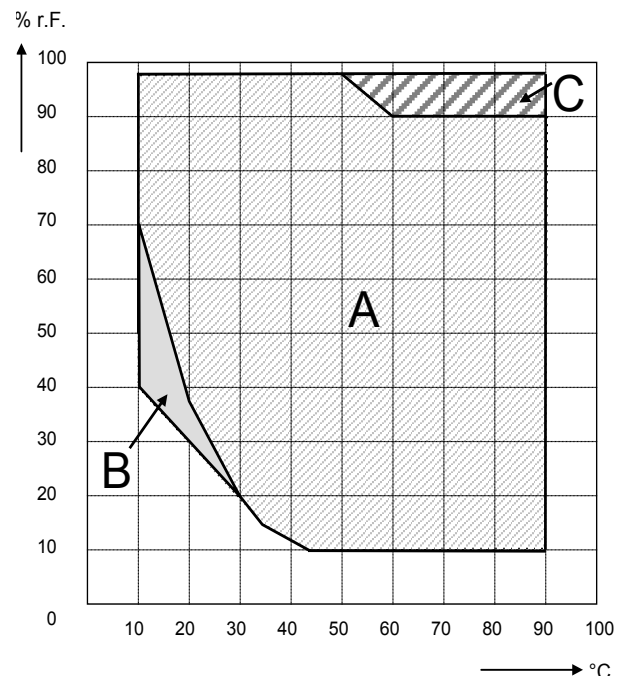

KMF temperature-humidity diagram

Figure 19: Temperature-humidity diagrams

Range A: Control range of temperature and relative humidity, condensation free range

Range B: Discontinuous range (no continuous operation, up to 24 h)

Range C: In this range, condensation in the inner chamber is possible



Heat emission of electrical devices connected inside the chamber may modify the temperature and humidity range.

The chambers are equipped with a door heating system to prevent condensation in the door area.

If the set points for temperature or humidity are outside the optimum range, condensation can arise in the door area.



CAUTION

Condensation by excess humidity.

Danger of corrosion on the housing after operating at humidity values > 70 % r.H. for a long period.

- Dry the appliance completely before shut-down:
 - Set the humidity to 0 % r.H. The humidity system must be activated.
 - Set the temperature set point to 60 °C / 140 °F for approx. 2 hours (Manual mode).
 - Only then, shut down the chamber at the main power switch (1) and close the water supply tap.



Having turned off the chamber by the main power switch (1), always close the water supply tap.

If you operate the chamber at high humidity and then immediately turn off the chamber, the internal wastewater collector may overflow due to the condensate. This may lead to the emergence of water at the chamber.



CAUTION

Overflow of the internal wastewater tank due to condensate.

Emergence of water at the chamber.

- ⊘ Following high humidity operation, do NOT directly turn off the chamber.
- Pump off the condensate before shut-down:
 - Set the humidity to 0 % r.H. The humidity system must be activated. Operate the chamber for at least 2 hours.
 - Only then, shut down the chamber at the main power switch (1) and close the water supply tap.

17.1 Function of the humidifying and dehumidifying system

Humidifying system

The humidifying and dehumidifying system is located in the humidity generation module. In a cylindrical container with a volume of about 2 liters an electrical resistance heating evaporates water. The water content is kept exactly at the boiling point, and thus steam can be immediately generated in sufficient quantity for rapid humidity increases or for compensation of humidity losses, e.g. by door openings. Condensation forming on the outer walls of the useable volume is led through a water drain in the outer chamber into the wastewater can which is pumped off automatically to the wastewater pipe when required.

Freshwater

You can supply the chamber with freshwater via a water pipe or by manually filling a freshwater can (option, chap. 19.9). You can mount the can on the rear of the chamber or place it next to the chamber.

	<p>In order to ensure accurate humidifying, observe the following points with regard to the freshwater supply:</p> <ul style="list-style-type: none"> • Supply pressure 1 to 10 bar when connecting to a water pipe • Water type: deionized (demineralized) water • To ensure humidification during 24 hours even at high humidity set-points with manual water supply, we recommend filling the freshwater can (option) at the end of each day. • Water intake temperature NOT below +5 °C / 41 °F and not exceeding 40 °C / 104 °F.
---	--

	<p>BINDER GmbH is NOT responsible for the water quality provided by the customer.</p> <p>Any problems and malfunctions that might arise following use of water of deviating quality is excluded from liability by BINDER GmbH.</p>
---	--

Automatic fresh water supply via water pipe

With this type of supply, the humidity system is continuously functional.

Manual fresh water supply via freshwater can (option, chap. 19.9)

With this type of supply, the humidity system is functional only if the water can is sufficiently filled. Check the filling level daily. The water reserve in the can is sufficient for a period, which may last between one and several days, depending on the humidity demand (entered humidity set-point and number of door openings).

Waste water

The condensation water from the interior is collected in an internal can with a volume of approx. 0.5 liters. It is pumped off via the waste water pipe.

Dehumidifying system

When the humidity system is activated, the chamber dehumidifies as needed in order to reach the entered humidity set-point inside the control range of temperature and relative humidity (Figure 19).

Dehumidification occurs in case of need by means of defined dew point undershoot of several evaporators of the refrigeration system. The condensate which forms is carried away as waste water.

If the humidity system is turned off while there are descending temperature curves, then operation of the refrigeration system may cause dehumidification of the charging material.

For error indications concerning water supply and humidity system, see chap. 11.1.3 and 22.

18. Defrosting at refrigerating operation

BINDER constant climate chambers are very diffusion-proof. To ensure high temperature precision there is no automatic cyclic defrosting device. The DCT™ refrigerating system largely avoids icing of the evaporation plates. However, at very low temperatures the moisture in the air can condense on the evaporator plates leading to icing.

	Always close the door properly.
---	---------------------------------

Operation with temperature set-points > +5 °C / 41 °F at an ambient temperature of 25 °C / 77 °F:

The air defrosts the ice cover automatically. Defrosting is continually performed.

Operation with temperature set-points < +5 °C / 41 °F:

Icing on the evaporator is possible. Defrost the chamber manually.

	<p>With temperature set-points < +5 °C / 41 °F, regularly defrost the chamber manually:</p> <ul style="list-style-type: none"> • Set the humidity to 0 % r.H. The humidity system must be activated. • Set the temperature to 40 °C / 104 °F (Manual Mode). • Let the chamber operate for about 30 minutes with the door closed.
---	--

	Too much ice on the evaporator is noticeable by reduced refrigerating performance.
--	--

When turning off the chamber following prolonged refrigerating operation below +5 °C / 41 °F, there is danger of overflowing due to uncontrolled defrosting of icing on the evaporator.

	CAUTION
	<p>Uncontrolled defrosting of icing on the evaporator.</p> <p>Danger of overflowing.</p> <p>After several days of refrigerating operation below +5 °C / 41 °F:</p> <ul style="list-style-type: none"> ⊘ Do NOT directly turn off the chamber. ➤ Manually defrost the chamber (see description above). ➤ Then, shut down the chamber at the main power switch (1) and close the tap of the water supply. Keep removed the access port plugs.

KMF: Operation with temperature set-points below 0°C / 32 °F:

While operating the chamber with set-points below < 0°C / 32 °F condensation is possible at the inner surface of the door around the door gasket.

	In case of heavy condensation, check tightness of the door gasket.
---	--

After one or two days operation at a set-point < 0°C / 32 °F a thin ice layer can cover the inner chamber door, the front margins of the inner kettles and may be the glass window.. The amount depends of the ambient temperature and humidity. This does not influence the proper function of the refrigerating system.

	Refrigerating performance decreases while operating the chamber at temperatures < 0 °C / 32 °F due to icing of the evaporators. For this reason defrost the chamber regularly, e.g. once a week.
---	--

19. Options

19.1 Communication software APT-COM™ 3 DataControlSystem (option)

The chamber is regularly equipped with an Ethernet interface (4) that can connect the BINDER communication software APT-COM™ 3 DataControlSystem. The actual temperature and humidity values are given at adjustable intervals. Programming can be performed graphically via PC. Up to 30 chambers with RS 422 interface can be cross-linked. The MAC Address is indicated in the "Device info" controller menu (chap. 15.4). For further information on networking please refer to the operating manual of the BINDER communication software APT-COM™ 3.

19.2 RS485 interface (option)

With this option, the chamber is equipped with an additional 2-wire RS485 serial interface (replacing the Ethernet interface) that can connect the BINDER communication software APT-COM™ 3 DataControlSystem. The actual temperature and humidity values are given at adjustable intervals. For further information, please refer to the operating manual of the BINDER communication software APT-COM™ 3.

19.3 Data logger kits (option)

BINDER Data Logger Kits offer an independent long-term measuring system for temperature and humidity, available for different temperature ranges. According to the selected kit, the Data Logger can measure and record also the ambient temperature and humidity values via a second multi-function sensor.

BINDER Data Loggers are equipped with a keyboard and a large LCD display, alarm functions and a real-time function. Measurement data are recorded in the Data Logger and can be read out after the measurement via the RS232 interface of the Data Logger. It offers a programmable measuring interval and permits storing up to 64000 measuring values. Reading out is done with the Data Logger evaluation software. You can give out a combined alarm and status protocol directly to a serial printer.

KBF: Data Logger Kit TH 70: Multi-function sensor for chamber temperature and humidity: Temperature range $-40\text{ }^{\circ}\text{C}$ / $-40\text{ }^{\circ}\text{F}$ up to $70\text{ }^{\circ}\text{C}$ / $158\text{ }^{\circ}\text{F}$, humidity range 0% r.H. up to 100% r.H.

KBF: Data Logger Kit TH 70/70: Multi-function sensor for chamber temperature and humidity: Temperature range $-40\text{ }^{\circ}\text{C}$ / $-40\text{ }^{\circ}\text{F}$ up to $70\text{ }^{\circ}\text{C}$ / $158\text{ }^{\circ}\text{F}$, humidity range 0% r.H. up to 100% r.H. Multi-function sensor for ambient temperature and humidity: Temperature range $-40\text{ }^{\circ}\text{C}$ / $-40\text{ }^{\circ}\text{F}$ up to $70\text{ }^{\circ}\text{C}$ / $158\text{ }^{\circ}\text{F}$, humidity range 0% r.H. up to 100% r.H.

KMF: Data Logger Kit TH 100: Multi-function sensor for chamber temperature and humidity: Temperature range $-40\text{ }^{\circ}\text{C}$ / $-40\text{ }^{\circ}\text{F}$ up to $+100\text{ }^{\circ}\text{C}$ / $212\text{ }^{\circ}\text{F}$, humidity range 0% r.H. up to 100% r.H.

KMF: Data Logger Kit TH 100/70: Multi-function sensor for chamber temperature and humidity: Temperature range $-40\text{ }^{\circ}\text{C}$ / $-40\text{ }^{\circ}\text{F}$ up to $+100\text{ }^{\circ}\text{C}$ / $212\text{ }^{\circ}\text{F}$, humidity range 0% r.H. up to 100% r.H. Multi-function sensor for ambient temperature and humidity: Temperature range $-40\text{ }^{\circ}\text{C}$ / $-40\text{ }^{\circ}\text{F}$ up to $70\text{ }^{\circ}\text{C}$ / $158\text{ }^{\circ}\text{F}$, humidity range 0% r.H. up to 100% r.H.



For detailed information on installation and operation of the BINDER Data Logger, please refer to the mounting instructions Art. No. 7001-0204 and to the original user manual of the manufacturer, supplied with the data logger.

19.4 Analog outputs for temperature and humidity (option)

With this option the chamber is equipped with analog outputs 4-20 mA for temperature and humidity. These outputs allow transmitting data to external data registration systems or devices.

The connection is realized as a DIN socket (3) in the right lateral control panel as follows:



ANALOG OUTPUT 4-20 mA DC

PIN 1: Temperature –

PIN 2: Temperature +

PIN 3: Humidity –

PIN 4: Humidity +

Temperature range: -10 °C / 14 °F to +100 °C / 212 °F

Humidity range: 0 % r.H. to 100 % r.H.

A suitable DIN plug is enclosed.

Figure 20: Pin allocation of DIN socket (3) for option analog outputs

19.5 Zero-voltage relay alarm outputs for temperature and humidity (option)

The chamber equipment with optional zero-voltage relay outputs for temperature and humidity (option) permits the transmission of alarms to a central monitoring system. Connection is established via a DIN socket (6) located on the right lateral control panel.



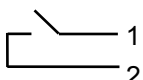
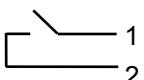

Figure 21: Pin configuration of the DIN socket (6)

Temperature contact	Humidity contact
 <p>Pin 1: Pin Pin 2: Make</p>	 <p>Pin 3: Pol Pin 4: Schließer</p>

In case of a temperature alarm, pins 1 and 2 are open; with humidity alarm, pins 3 and 4 are open. This happens simultaneously with the alarm message shown on the controller display.

In case of power failure, both contacts are open.

Maximum loading capacity of the switching contacts: 24V AC/DC - 2,5A

	 DANGER
	<p>Electrical hazard.</p> <p>Danger of death.</p> <p>Damage to switching contacts and connection socket.</p> <ul style="list-style-type: none"> ⊘ Do NOT exceed the maximum switching load of 24V AC/DC – 2.5A. ⊘ Do NOT connect any devices with a higher loading capacity.

A temperature and humidity alarm message will remain visible on the controller display during the whole time of the alarm transmission via the zero-voltage relay outputs.

As soon as the cause of the alarm is rectified, you can reset the alarm transmission via the zero-voltage relay outputs together with the alarm message on the controller.

In case of power failure, transmission of the alarm via zero-voltage relay outputs remains active for the duration of the power failure. Afterwards, both contacts will close automatically.

	<p>When using the communication software APT-COM™ 3 DataControlSystem (option, chap. 19.1) via the Ethernet interface of the constant climate chamber for data acquisition, the alarm is not automatically transmitted to the APT-COM™ protocol.</p> <ul style="list-style-type: none"> ➤ Set the tolerance limits for recording limit value excesses separately in APT-COM™ 3.
---	--



19.6 Water protected internal socket (option for KBF – not for UL chambers)

The internal socket is splash proof.

IP system of protection 67 230 V 1N ~ 50-60 Hz

Charge max. 500 W

Maximum permitted operating temperature with this option: 90 °C / 194 °F.

	 WARNING
	<p>Exceeding the permitted maximum temperature.</p> <p>Electrical hazard.</p> <p>Danger of death.</p> <p>Damage to the internal socket.</p> <ul style="list-style-type: none"> ⊘ Do NOT exceed the temperature set-point of 90 °C / 194 °F. ➤ Set the safety controller to 90 °C / 194 °F. ➤ With optional temperature safety device, class 3.3, set the mechanical thermostat class 3.1 to 90 °C / 194 °F.

	<p>Heat emission of electrical devices connected inside the chamber may modify the temperature and humidity range.</p>
---	--

	CAUTION
	<p>Risk of short circuit.</p> <p>Damage to the chamber.</p> <ul style="list-style-type: none"> ➤ Use the supplied plug only (IP protection type 67). Plug it in and tighten it by screwing to secure contact. ➤ If the socket is not used, close the screw lid and turn it to secure.

19.7 Additional flexible Pt 100 temperature sensor (available via BINDER INDIVIDUAL customized solutions)

An additional flexible temperature sensor Pt100 allows measuring the temperature of the charging material by means of an independent measuring system utilizing Pt 100 entry. The Pt 100 sensor's top protective tube can be immersed into liquid substances

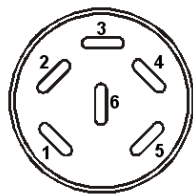

Pt 100 Sensor

PIN 1: Pt 100
PIN 2: Pt 100
PIN 3: Pt 100

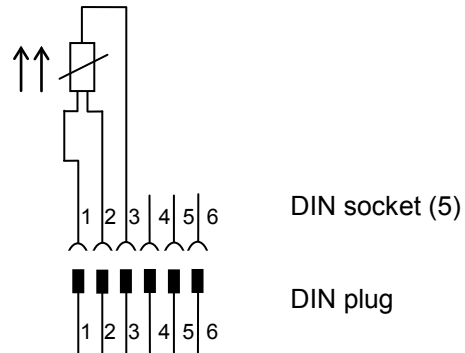

A suitable DIN plug is enclosed.

Figure 22: Pin configuration of the DIN socket (5) in the right lateral control panel

Technical data of the Pt100 sensor:

- Three-wire technique
- Class B (DIN EN 60751)
- Temperature range up to 320 °C / 608 °F
- Stainless steel protective tube with a length of 45 mm / 1.78 in, material no. 1.4501

19.8 Object temperature display with flexible Pt 100 temperature sensor (option)

The object temperature display enables the determination of the actual temperature of the charging material during the whole process. The object temperature is measured via a flexible Pt100 temperature sensor and can be viewed on the controller display. You can immerse the sensor top protective tube of the flexible Pt 100 into liquid substances.

Fixed value		Setpoint	Actual value
Temperature	°C	10.0	11.1
Humidity	%RH	90.0	98.1
Obj. Temp.	°C		10.6

Normal display with object temperature display (sample values)

The object temperature data are put out together with the data of the temperature controller and can be documented by the communication software APT-COM™ (option, chap. 19.1) developed by BINDER.

Technical data of the Pt100 sensor:

- Three-wire technique
- Class B (DIN EN 60751)
- Temperature range up to 320 °C / 608 °F
- Stainless steel protective tube with a length of 45 mm / 1.78 in, material no. 1.4501

19.9 External freshwater and wastewater cans (option)

If no suitable in-house water connection is available, you can manually supply water by filling the optional external freshwater can. There is an additional external water can for the waste water. Volume: 20 liters / 0.71 cu.ft.

The cans are placed in holding devices. You can affix them directly at the rear of the chamber or place them next to the chamber.

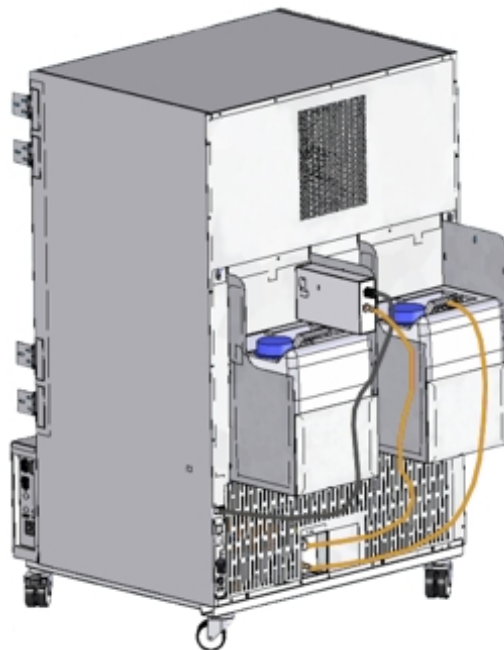

Figure 23: Rear view KMF with installed external water cans (option)

19.9.1 Mounting the freshwater can

(1) Fixing (if required)

Hang the can with its holding device on its 4 carriers. You can install it either at the left or the right side.

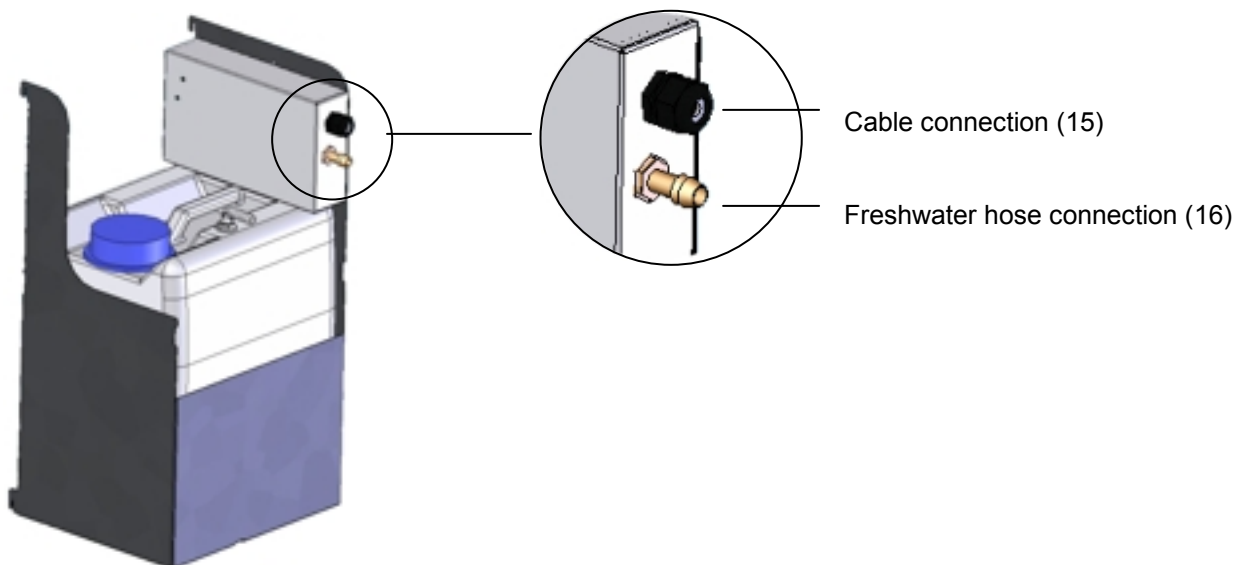

Figure 24: Freshwater can (option)

(2) Cable connections

Connect the plug of the cable to the socket (10) at the rear of the chamber.

The socket (10) is marked with a sticker:

**WATER TANK
24 VDC/MAX 0.2A**

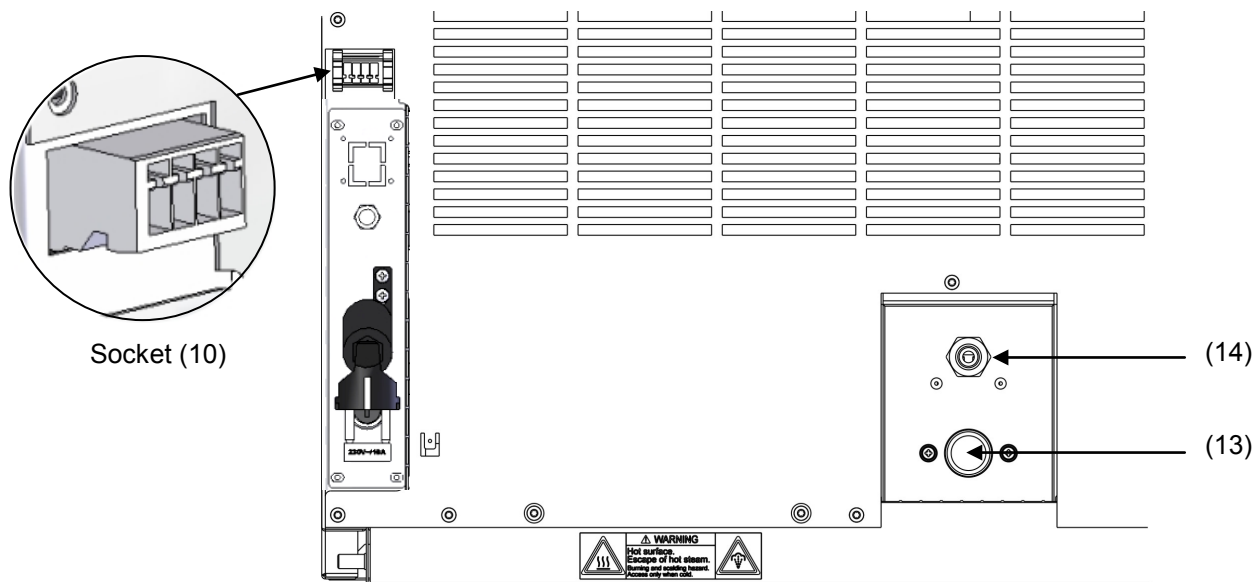



Figure 25: Connections at the chamber rear

(3) Hose connections

Plug the freshwater hose into the hose connection (16) above the freshwater can and secure it with a hose clamp. You can use a part of the standard supplied water hose.

Screw the hose nozzle (brass) to the free edge of the hose and screw it directly onto the freshwater connection "IN" (13) at the rear of the chamber.

When the freshwater can is empty, the message **Freshwater supply** will be displayed on the controller (chap. 11.1.3), the buzzer sounds, and the humidification module turns off. After acknowledging the alarm, the humidification module tries to fill up and start operating.

 To guarantee humidification during 24 hours even at high humidity set-points with manual water supply, we recommend filling the freshwater can (option) at the end of each day.

19.9.2 Mounting the wastewater can

(1) Fixing (if required)

Hang the can with its holding device on its 4 carriers at the free space next to the freshwater can.

(2) Hose connections

Plug the wastewater hose to the hose connection (17) of the can and secure it with a hose clamp. You can use a part of the standard supplied water hose.

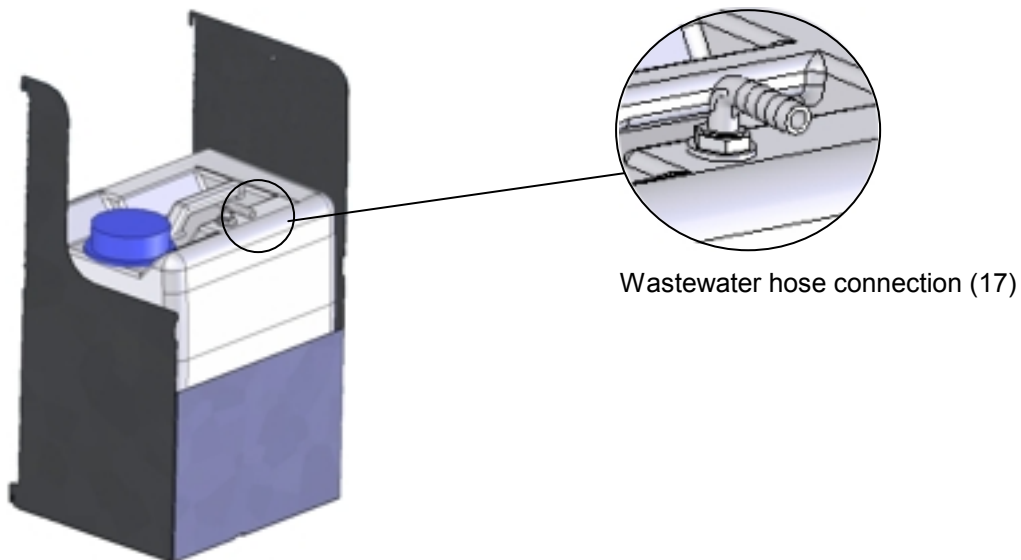



Figure 26: Wastewater can (option)

Plug the free hose edge to the wastewater connection "OUT" (14) at the rear of the chamber and secure it with a hose clamp.

You can remove the wastewater can with its holding device for emptying (disconnect the hose first before emptying).

	CAUTION
	<p>Overflow of the wastewater can. Damage to the surrounding.</p> <ul style="list-style-type: none"> ➤ Empty the wastewater can in a timely manner before it is full.

	<p>Bringing a source of humidity into the inner chamber may increase wastewater production. Regularly check the filling level of the wastewater can.</p>
---	--

19.9.3 Mounting with wastewater recycling

When the chamber interior is clean, you can reuse the wastewater from the chamber. Connect the wastewater connection "OUT" (14) of the chamber with the freshwater hose connection (18) of the freshwater can. The wastewater can is not used in this case.

	CAUTION
	<p>Soiling of the vapor humidification system.</p> <p>Damage to the chamber.</p> <ul style="list-style-type: none"> ➤ Reuse wastewater ONLY with a clean chamber interior. ➤ In case of soiling / contamination of the interior, conduct the wastewater to the wastewater connection or use the wastewater can.

(1) Fixing of the freshwater can (if required)

Hang the can with its holding device on its 4 carriers. You can install it either at the left or the right side.

(2) Cable connections of the freshwater can

Connect the plug of the cable to the socket (10) at the rear of the chamber as described in chap. 19.9.1.

(3) Hose connections

Plug the wastewater hose into the hose connection (18) of the freshwater can and secure it with a hose clamp. You can use a part of the standard supplied water hose.

Plug the free hose edge to the wastewater connection "OUT" (14) at the rear of the chamber and secure it with a hose clamp.

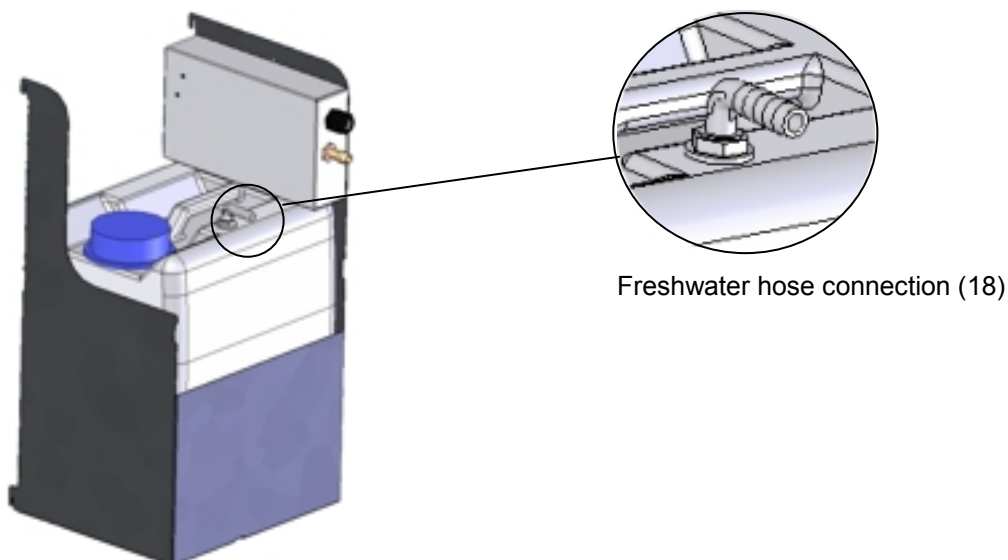



Figure 27: Freshwater can (option)

	<p>Bringing a source of humidity into the inner chamber may increase wastewater production. Regularly check the filling level of the freshwater can.</p>
---	--



19.10 BINDER Pure Aqua Service (option)

The optional BINDER water treatment system (disposable unit) is available to treat tap water. The lifetime of the unit depends on water quality and the amount of treated water used. The measuring equipment to assess the water quality is reusable.

	<p>For detailed information on operating the water treatment system BINDER Pure Aqua Service and its function, please refer to the operating manual Art. No. 7001-0269, delivered with BINDER Pure Aqua Service.</p>
---	--

20. Maintenance, cleaning, and service

20.1 Maintenance intervals, service

 	<div style="background-color: red; color: white; padding: 5px; text-align: center;">  DANGER </div> <p>Electrical hazard. Danger of death.</p> <ul style="list-style-type: none"> Ø The chamber must NOT become wet during operation or maintenance works. Ø Do not remove the rear panel of the chamber. ➤ Before conducting maintenance work, turn off the chamber at the main power switch and disconnect the power plug. ➤ General maintenance work must be conducted by licensed electricians or experts authorized by BINDER. ➤ Maintenance work at the refrigeration system must only be conducted by qualified personnel who underwent training in accordance with EN 13313:2010 (e.g. a refrigeration technician with certified expert knowledge acc. to regulation 303/2008/EC). Follow the national statutory regulations.
--	---

Ensure regular maintenance work is performed at least once a year and that the legal requirements are met regarding the qualifications of service personnel, scope of testing and documentation. All work on the refrigeration system (repairs, inspections) must be documented.

	<p>The warranty becomes void if maintenance work is conducted by non-authorized personnel.</p>
---	--

Have conducted regular maintenance work on the steam humidifier at least once a year. The operating behavior and the maintenance intervals of the humidifier essentially depend on the available water quality and the amount of steam produced in the meantime.

	<p>We recommend cleaning the condensers at least twice a year. A qualified technician must perform cleaning.</p>
---	--

	<p>Replace the door gasket only when cold. Otherwise, the door gasket may become damaged.</p>
---	---

With an increased amount of dust in the ambient air, clean the condenser fan (by suction or blowing) several times a year.



We recommend taking out a maintenance agreement. Please consult BINDER Service:

BINDER telephone hotline:	+49 (0) 7462 2005 555
BINDER fax hotline:	+49 (0) 7462 2005 93555
BINDER e-mail hotline:	service@binder-world.com
BINDER service hotline USA:	+1 866 885 9794 or +1 631 224 4340 x3 (toll-free in the USA)
BINDER service hotline Asia Pacific:	+852 390 705 04 or +852 390 705 03
BINDER service hotline Russia and CIS	+7 495 988 15 16
BINDER Internet website	http://www.binder-world.com
BINDER address	BINDER GmbH, post office box 102, 78502 Tuttlingen, Germany

International customers, please contact your local BINDER distributor.

20.2 Cleaning and decontamination

Clean the chamber after each use to avoid potential corrosion damage by ingredients of the test material.

	 DANGER
	<p>Electrical hazard.</p> <p>Danger of death.</p> <ul style="list-style-type: none"> ⊘ Do NOT spill water or cleaning agents over the inner and outer surfaces. ➤ Before cleaning, turn off the chamber at the main power switch and disconnect the power plug. ➤ Completely dry the appliance before turning it on again.

20.2.1 Cleaning

Disconnect the chamber from the power supply before cleaning. Disconnect the power plug.

	The interior of the chamber must be kept clean. Thoroughly remove any residues of test material.
---	--

Wipe the surfaces with a moistened towel. In addition, you can use the following cleaning agents:

Exterior surfaces inner chamber racks door gaskets	Standard commercial cleaning detergents free from acid or halides. Alcohol-based solutions. We recommend using the neutral cleaning agent Art. No. 1002-0016.
Instrument panel	Standard commercial cleaning detergents free from acid or halides. We recommend using the neutral cleaning agent Art. No. 1002-0016.
Zinc coated hinge parts rear chamber wall	Standard commercial cleaning detergents free from acid or halides. Do NOT use a neutral cleaning agent on zinc coated surfaces.

Do not use cleaning agents that may cause a hazard due to reaction with components of the device or the charging material. If there is doubt regarding the suitability of cleaning products, please contact BINDER service.

	<p>We recommend using the neutral cleaning agent Art. No. 1002-0016 for a thorough cleaning.</p> <p>Any corrosive damage that may arise following use of other cleaning agents is excluded from liability by BINDER GmbH.</p> <p>Any corrosive damage caused by a lack of cleaning, is excluded from liability by BINDER GmbH.</p>
---	--

	CAUTION
	<p>Danger of corrosion.</p> <p>Damage to the chamber.</p> <ul style="list-style-type: none"> ∅ Do NOT use acidic or chlorine cleaning detergents. ∅ Do NOT use a neutral cleaning agent on other kind of surfaces e.g., the zinc coated hinge parts or the rear chamber wall.

	<p>For surface protection, perform cleaning as quickly as possible.</p> <p>After cleaning completely remove cleaning agents from the surfaces with a moistened towel. Let the chamber dry.</p>
---	--







	<p>Soapsuds may contain chlorides and must therefore NOT be used for cleaning.</p>
---	--

	<p>With every cleaning method, always use adequate personal safety controls.</p>
---	--

Following cleaning, leave the chamber door open or remove the access port plugs.

	<p>The neutral cleaning agent may cause health problems in contact with skin and if ingested. Follow the operating instructions and safety hints labeled on the bottle of the neutral cleaning agent.</p>
---	---

Recommended precautions: To protect the eyes use sealed protective goggles. Suitable protective gloves with full contact: butyl or nitrile rubber, penetration time >480 minutes.

 	 CAUTION
 	<p>Contact with skin, ingestion.</p> <p>Skin and eye damage due to chemical burns.</p> <ul style="list-style-type: none"> ∅ Do not ingest. Keep away from food and beverages. ∅ Do NOT empty into drains. ➤ Wear protective gloves and goggles. ➤ Avoid skin contact.
	

20.2.2 Decontamination

The operator must ensure that proper decontamination is performed in case a contamination of the chamber by hazardous substances has occurred.

Disconnect the chamber from the power supply prior to chemical decontamination. Pull the power plug.

Do not use decontamination agents that may cause a hazard due to reaction with components of the device or the charging material. If there is doubt regarding the suitability of cleaning products, please contact BINDER service.

You can use the following disinfectants:

Inner chamber	Standard commercial surface disinfectants free from acid or halides. Alcohol-based solutions. We recommend using the disinfectant spray Art. No. 1002-0022.
---------------	---

	For chemical disinfection, we recommend using the disinfectant spray Art. No. 1002-0022. Any corrosive damage that may arise following use of other disinfectants is excluded from liability by BINDER GmbH.
---	--

	With every decontamination method, always use adequate personal safety controls.
---	--

In case of contamination of the interior by biologically or chemically hazardous material, there are two possible procedures depending on the type of contamination and charging material:



1. Spray the inner chamber with an appropriate disinfectant.

Before start-up, the chamber must be absolutely dry and ventilated, as explosive gases may form during the decontamination process.

2. If necessary, have strongly contaminated inner chamber parts removed by an engineer for cleaning, or have them exchanged. Sterilize the inner chamber parts in a sterilizer or autoclave.

	In case of eye contact, the disinfectant spray may cause eye damage due to chemical burns. Follow the operating instructions and safety hints labeled on the bottle of the disinfectant spray.
---	--

Recommended precautions: To protect the eyes use sealed protective goggles.

	<div style="background-color: yellow; text-align: center; padding: 5px;">  CAUTION </div> <p>Eye contact. Eye damage due to chemical burns.</p> <ul style="list-style-type: none"> ⊘ Do NOT empty into drains. ➤ Wear protective goggles.
---	---

	After using the disinfectant spray, allow the chamber to dry thoroughly, and aerate it sufficiently.
---	--

20.3 Sending the chamber back to BINDER GmbH

If you return a BINDER product to us for repair or any other reason, we will only accept the product upon presentation of an **authorization number** (RMA number) that has previously been issued to you. An authorization number will be issued after receiving your complaint either in writing or by telephone **prior** to your sending the BINDER product back to us. The authorization number will be issued following receipt of the information below:

- BINDER product type and serial number
- Date of purchase
- Name and address of the dealer from which you bought the BINDER product
- Exact description of the defect or fault
- Complete address, contact person and availability of that person
- Exact location of the BINDER product in your facility
- A contamination clearance certificate (chap. 26) must be faxed in advance

The authorization number must be applied to the packaging in such a way that it can be easily recognized or be recorded clearly in the delivery documents.



For security reasons we cannot accept a chamber delivery if it does not carry an authorization number.

Return address: BINDER GmbH Gänsäcker 16
 Abteilung Service 78502 Tuttlingen
 Germany

21. Disposal

21.1 Disposal of the transport packing

Packing element	Material	Disposal
Straps to fix packing on pallet	Plastic	Plastic recycling
Wooden transport box (option) with metal screws	Non-wood (compressed match-wood, IPPC standard)	Wood recycling
	Metal	Metal recycling
Pallet with foamed plastic stuffing	Solid wood (IPPC standard)	Wood recycling
	PE foam	Plastic recycling
Transport box with metal clamps	Cardboard	Paper recycling
	Metal	Metal recycling
Top cover	Cardboard	Paper recycling
Edge protection	Styropor® or PE foam	Plastic recycling
Protection of doors and racks	PE foam	Plastic recycling
Bag for operating manual	PE foil	Plastic recycling
Insulating air cushion foil (packing of optional accessories)	PE foil	Plastic recycling

If recycling is not possible, all packing parts can also be disposed of with normal waste.

21.2 Decommissioning

- Turn off the chamber at the main power switch (1) and disconnect it from the power supply.
- Close the tap used for the water supply.
- Turn off humidity control (chap. 6.3).
- Remove the water installation.
- Temporal decommissioning: See indications for appropriate storage, chap. 3.3.
- Final decommissioning: Dispose of the chamber as described in chap. 21.3 to 21.5.

21.3 Disposal of the chamber in the Federal Republic of Germany

According to Annex I of Directive 2012/19/EU of the European Parliament and of the Council on waste electrical and electronic equipment (WEEE), BINDER devices are classified as “monitoring and control instruments” (category 9) only intended for professional use“. They must not be disposed of at public collecting points.

The chambers bear the symbol for the marking of electrical and electronic equipment manufactured / placed on the market in the EU after 13 August 2005 and be disposed of in separate collection according to Directive 2012/19/EU on waste electrical and electronic equipment (WEEE) and German national law for electrical and electronic equipment (Elektro- und Elektronikgerätegesetz, ElektroG). WEEE marking: crossed-out wheeled bin with solid bar under. A significant part of the materials must be recycled in order to protect the environment.

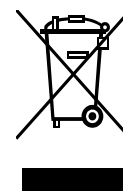



At the end of the device's service life, have the chamber disposed of according to the German national law for electrical and electronic equipment (Elektro- und Elektronikgerätegesetz, ElektroG from 20 October 2015, BGBl. I p. 1739) or contact BINDER service who will organize taking back and disposal of the chamber according to the German national law for electrical and electronic equipment (Elektro- und Elektronikgerätegesetz, ElektroG from 20 October 2015, BGBl. I p. 1739).

	<h3>CAUTION</h3>
<p>Violation against existing law.</p> <ul style="list-style-type: none"> Ø Do NOT dispose of BINDER devices at public collecting points. ➤ Have the device disposed of professionally at a recycling company which is certified according to the German national law for electrical and electronic equipment (Elektro- und Elektronikgerätegesetz, ElektroG from 20 October 2015, BGBl. I p. 1739). <li style="text-align: center;"><i>or</i> ➤ Instruct BINDER Service to dispose of the device. The general terms of payment and delivery of BINDER GmbH apply, which were valid at the time of purchasing the chamber. 	

Certified companies disassemble waste (used) BINDER equipment in primary substances for recycling according to Directive 2012/19/EU. The devices must be free from toxic, infectious or radioactive substances in order to eliminate any health hazards to the employees of the recycling companies.

	<p>Prior to handing the chamber over to a recycling company, it is the user's responsibility that it is free from toxic, infectious or radioactive substances.</p> <ul style="list-style-type: none"> • Prior to disposal, clean all introduced or residual toxic substances from the chamber. • Prior to disposal, disinfect the chamber from all sources of infection. Be aware that sources of infection may also be located outside the inner chamber. • If you cannot safely remove all toxic substances and sources of infection from the chamber, dispose of it as special waste according to national law. • Fill out the contamination clearance certificate (chap. 26) and enclose it with the chamber.
---	---

 	 WARNING
	<p>Contamination of the device with toxic, infectious or radioactive substances.</p> <p>Danger of intoxication.</p> <p>Danger of infection.</p> <ul style="list-style-type: none"> ⊘ NEVER take a chamber contaminated with toxic substances or sources of infection for recycling according to Directive 2012/19/EU. ➤ Prior to disposal, remove all toxic substances and sources of infection from the chamber. ➤ A chamber from which all toxic substances or sources of infection cannot be safely removed must be considered as “special” waste according to national law. Dispose of it accordingly.

The refrigerant used R 134A (1,1,1,2-tetrafluoroethane) is not inflammable at ambient pressure. It must not escape into the environment. In Europe, recovery of the refrigerant R 134A (1300) is mandatory according to regulation No. 842/2006/EC. Ensure the compliance with the applicable legal requirements regarding qualification of staff, disposal, and documentation.

21.4 Disposal of the chamber in the member states of the EC except for the Federal Republic of Germany

According to Annex I of Directive 2012/19/EU of the European Parliament and of the Council on waste electrical and electronic equipment (WEEE), BINDER devices are classified as “monitoring and control instruments” (category 9) only intended for professional use“. They must not be disposed of at public collecting points.

The chambers bear the symbol for the marking of electrical and electronic equipment manufactured / placed on the market in the EC after 13 August 2005 and be disposed of in separate collection according to the Directive 2012/19/EU on waste electrical and electronic equipment (WEEE). WEEE marking: crossed-out wheeled bin with solid bar under.

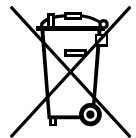



At the end of the device's service life, notify the distributor who sold you the device, who will take back and dispose of the chamber according to the Directive 2012/19/EU on waste electrical and electronic equipment (WEEE).

	CAUTION
	<p>Violation against existing law.</p> <ul style="list-style-type: none"> ⊘ Do NOT dispose of BINDER devices at public collecting points. ➤ Have the device disposed of professionally at a recycling company that is certified according to conversion of the Directive 2012/19/EU into national law. <i>or</i> ➤ Instruct the distributor who sold you the device to dispose of it. The agreements apply that were agreed with the distributor when purchasing the chamber (e.g. his general terms of payment and delivery). ➤ If your distributor is not able to take back and dispose of the chamber, please contact BINDER service.

Certified companies disassemble waste (used) BINDER equipment in primary substances for recycling according to Directive 2012/19/EU. The devices must be free from toxic, infectious or radioactive substances in order to eliminate any health hazards to the employees of the recycling companies.

	<p>Prior to handing the chamber over to a recycling company, it is the user's responsibility that it is free from toxic, infectious or radioactive substances.</p> <ul style="list-style-type: none"> • Prior to disposal, clean all introduced or residual toxic substances from the chamber. • Prior to disposal, disinfect the chamber from all sources of infection. Be aware that sources of infection may also be located outside the inner chamber. • If you cannot safely remove all sources of infection and toxic substances from the chamber, dispose of it as special waste according to national law. • Fill out the contamination clearance certificate (chap. 26) and enclose it with the chamber.
---	---

	 WARNING
	<p>Contamination of the device with toxic, infectious or radioactive substances.</p> <p>Danger of intoxication.</p> <p>Danger of infection.</p> <ul style="list-style-type: none"> ⊘ NEVER take a chamber contaminated with toxic substances or sources of infection for recycling according to Directive 2012/19/EU. ➤ Prior to disposal, remove all toxic substances and sources of infection from the chamber. ➤ A chamber from which all toxic substances or sources of infection cannot be safely removed must be considered as "special" waste according to national law. Dispose of it accordingly.

The refrigerant used R 134A (1,1,1,2-tetrafluoroethane) is not inflammable at ambient pressure. It must not escape into the environment. In Europe, recovery of the refrigerant R 134A (1300) is mandatory according to regulation No. 842/2006/EC. Ensure the compliance with the applicable legal requirements regarding qualification of staff, disposal, and documentation.

21.5 Disposal of the chamber in non-member states of the EC

	CAUTION
	<p>Alteration of the environment.</p> <ul style="list-style-type: none"> ➤ For final decommissioning and disposal of the constant climate chamber, please contact BINDER service. ➤ Follow the statutory regulations for appropriate, environmentally friendly disposal.

The main board of the constant climate chamber includes a lithium cell. Please dispose of it according to national regulations.

The refrigerant used R 134A (1,1,1,2-tetrafluoroethane) is not inflammable at ambient pressure. It must not escape into the environment. In Europe, recovery of the refrigerant R 134A (1300) is mandatory according to regulation No. 842/2006/EC. Ensure the compliance with the applicable legal requirements regarding qualification of staff, disposal, and documentation.

22. Troubleshooting

Fault description	Possible cause	Required measures
General		
Chamber without function.	No power supply.	Check connection to power supply.
	Wrong voltage.	Check power supply for correct voltage (chap. 4.4).
	Chamber fuse has responded.	Check chamber fuse and replace it if appropriate. If it responds again, contact BINDER service.
	Controller defective.	Contact BINDER service.
	Nominal temperature exceeded by 10° due to chamber failure. Over temperature protective device (class 1) responds.	
Heating		
Chamber heating permanently, set-point not maintained.	Controller defective.	Contact BINDER service.
	Semiconductor relay defective.	
	Controller not well adjusted, or adjustment interval exceeded.	Calibrate and adjust controller.
Chamber doesn't heat up.	Pt 100 sensor defective.	Contact BINDER service.
	Heating element defective.	
	Semiconductor relay defective	
Chamber doesn't heat up when turned on. Safety controller responds.	Inner chamber temperature has reached the safety controller set-point. Safety controller set too low.	Acknowledge the alarm. Check temperature setpoint setting. If appropriate, select suitable safety controller setpoint (chap. 12.2).
	Safety controller (chap. 12.2) defective.	Contact BINDER service.
Mechanical safety device class 3.1 responds (with option safety device class 3.3).	Limit temperature reached.	Check setting of temperature set-point and safety device class 3.1. If appropriate, select suitable limit value.
	Too much external heat load.	Reduce heat load.
	Controller defective.	Contact BINDER service.
	Safety device defective.	
Mechanical safety device class 3.2 responds (with option safety device class 3.3).	Semi-conductor relay defective	Contact BINDER service.
	Limit temperature reached.	
	Controller or safety device defective.	Contact BINDER service.

Fault description	Possible cause	Required measures
Refrigerating performance		
Low or no refrigerating performance.	Ambient temperature > 25 °C / 77 °F (chap.3.4).	Select cooler place of installation.
	Combination of temperature/humidity values not in the optimum range (see temperature humidity diagram, Figure 19).	Select combination of temperature/humidity values in the optimum range (chap. 17).
	Compressor not turned on.	Contact BINDER service.
	Electro-valves defective.	
	No or not enough refrigerant.	
Too much external heat load.	Reduce heat load.	
Humidity		
Humidity fluctuation: Control accuracy of $\pm 3\%$ r.F. is not reached.	Door gasket defective.	Replace door gasket.
	Door opened very frequently.	Open doors less frequently.
Humidity fluctuation, together with temperature fluctuation > 1 °C with a set-point ca. 3 °C above ambient temperature.	Place of installation too hot.	Select cooler place of installation or contact BINDER service.
Low or no dehumidification.	Capillary tube blocked	Contact BINDER service.
	Not enough refrigerant.	
	Humidity control turned off.	Turn on humidity control (chap. 6.3, 7.3).
Icing at the evaporator plates.	Set-point was too long-below ambient temperature.	Defrost the unit (chap. 18).
Condensation at the walls of the inner chamber.	Combination of temperature/humidity values not in the optimum range (see temperature humidity diagram, Figure 19)	Select combination of temperature/humidity values in the optimum range (chap. 17).
	Set-point was too long below ambient temperature, icing in the preheating chamber.	Defrost the chamber (chap. 18)
Low humidity and temperature accuracy	Fan speed has been reduced.	Set fan speed to 100%.
Controller		
No chamber function (dark display).	Display in standby mode.	Press on touchscreen.
	Main power switch turned off.	Turn on the main power switch.
Menu functions not available.	Menu functions not available with current authorization level.	Log in with the required higher authorization.
No access to controller	Password incorrect.	Contact BINDER service.
Chart recorder function: measured-value memory cleared; information lost.	New setting of storage rate or scaling (minimum and/or maximum) (chap. 16.2).	Change the storage rate or scaling ONLY if the previously registered data are no longer required.
Controller does not equilibrate to setpoints entered in Fixed value operation mode	Controller is not in Fixed value operation mode.	Change to Fixed value operation mode.
Controller does not equilibrate to program set-points.	Controller is not in program operation mode, or program delay time is running.	Start the program again. If appropriate, wait for the program delay time.
Program duration longer than programmed.	Tolerances have been programmed.	For rapid transition phases, do NOT program tolerance limits in order to permit maximum heating, refrigerating, or humidification speed.

Fault description	Possible cause	Required measures
Controller (continued)		
Program keeps the last program setpoint constant while in setting "ramp".	Program line with setting "ramp" is incomplete.	When programming with setting "ramp", define the end value of the desired cycle by adding an additional section with a section time of at least one second.
Ramp temperature transitions are only realized as steps.	Setting "step" has been selected.	Select setting "ramp".
Humidity alarm when operating without water connection.	Humidity control turned on.	Turn off humidity control (chap. 6.3).
Acknowledging the alarm does not cancel the alarm state.	Cause of alarm persists.	Remove cause of alarm. If the alarm state continues, contact BINDER service.
Alarm message: ---- or <-<-< or >->->	Sensor rupture between sensor and controller or Pt 100 sensor defective.	Contact BINDER service.
	Short-circuit.	
Miscellaneous		
Impaired valve function of hose burst protection.	Calcification.	Remove calcifications by citric acid or acetic acid solutions (chap. 4.3.4). Have a plumber inspect the valve.



Only qualified service personnel authorized by BINDER must perform repair.
Repaired chambers must comply with the BINDER quality standards.

23. Technical description

23.1 Factory calibration and adjustment

This chamber was calibrated and adjusted in the factory. Calibration and adjustment were performed using standardized test instructions, according to the QM DIN EN ISO 9001 system applied by BINDER (certified since December 1996 by TÜV CERT). All test equipment used is subject to the administration of measurement and test equipment that is also a constituent part of the BINDER QM DIN EN ISO 9001 systems. They are controlled and calibrated to a DKD-Standard at regular intervals.

23.2 Over current protection

The devices are equipped with an internal fuse not accessible from outside. If this fuse is blown, please contact an electronic engineer or BINDER service.

23.3 Definition of usable volume

The usable volume illustrated below is calculated as follows:

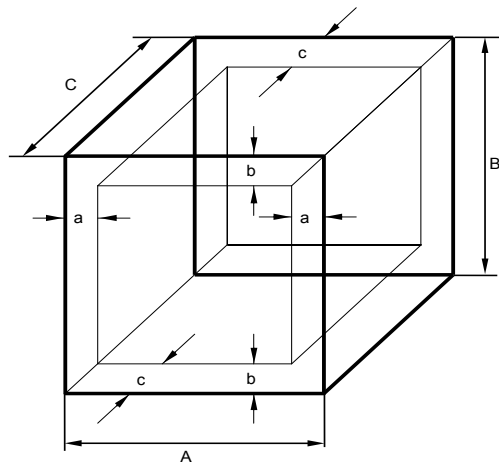

A, B, C = internal dimensions (W, H, D)

a, b, c = distance to wall

$$a = 0.1 \cdot A$$

$$b = 0.1 \cdot B$$

$$c = 0.1 \cdot C$$

$$V_{USE} = (A - 2 \cdot a) \cdot (B - 2 \cdot b) \cdot (C - 2 \cdot c)$$

Figure 28: Determination of the useable volume

The technical data refers to the defined usable volume.

	Do NOT place samples outside this usable volume.
	Do NOT load this volume by more than half to enable sufficient airflow inside the chamber.
	Do NOT divide the usable volume into separate parts with large area samples.
	Do NOT place samples too close to each other in order to permit circulation between them and thus obtain a homogenous distribution of temperature and humidity.

23.4 KBF Technical Data

Chamber size		115	240	720	1020
Exterior dimensions					
Width, net	mm / inch	880 / 34.65	925 / 36.42	1250 / 49.21	1250 / 49.21
Height, gross (incl. feet/castors)	mm / inch	1050 / 41.34	1460 / 57.48	1925 / 75.79	1925 / 75.79
Depth, net	mm / inch	650 / 25.59	800 / 31.50	890 / 35.04	1145 / 45.08
Depth, gross (including door handle, I-triangle, connection and 30 mm for cable)	mm / inch	730 / 28.74	880 / 34.65	970 / 38.19	1230 / 48.43
Wall clearance rear (minimum) (spacer)	mm / inch	100 / 3.94	100 / 3.94	100 / 3.94	100 / 3.94
Wall clearance side (minimum)	mm / inch	100 / 3.94	100 / 3.94	100 / 3.94	100 / 3.94
Doors					
Quantity of doors		1	1	2	2
Quantity of inner glass doors		1	1	2	2
Interior dimensions					
Width	mm / inch	600 / 23.62	650 / 25.60	973 / 38.31	973 / 38.31
Height	mm / inch	483 / 19.02	785 / 30.91	1250 / 49.21	1250 / 49.21
Depth	mm / inch	351 / 13.82	485 / 19.09	576 / 22.68	836 / 32.91
Interior volume	l / cu.ft.	102 / 3.6	247 / 8.7	700 / 24.7	1020 / 36.0
Steam space volume	l / cu.ft.	156 / 5.5	348 / 12.3	918 / 32.4	1280 / 45.2

Chamber size		115	240	720	1020	
Racks						
Quantity of racks (regular)		2	2	2	2	
Quantity of racks (max.)		5	9	15	15	
Maximum load per rack	kg / lbs.	30 / 66	30 / 66	45 / 99	45 / 99	
Maximum permitted total load	kg / lbs.	100 / 220	100 / 220	150 / 331	150 / 331	
Weight						
Weight (empty)	kg / lbs.	129 / 284	184 / 406	309 / 681	365 / 805	
Temperature data (without humidity)						
Temperature range	°C / °F	0 to +70 / 32 to 158	0 to +70 / 32 to 158	0 to +70 / 32 to 158	0 to +70 / 32 to 158	
Temperature fluctuation	± K	0.1	0.1	0.1	0,5	
Temperature uniformity (variation)	at 25 °C / 77 °F	± K	0.2	0.2	0,2	
	at 40 °C / 104 °F	± K	0.2	0.3	0,2	
Max. heat compensation at 40 °C / 104 °F	W	200	300	600	600	
Climatic data (with humidity)						
Temperature range	°C / °F	+10 to +70 / 50 to 158	+10 to +70 / 50 to 158	+10 to +70 / 50 to 158	+10 to +70 / 50 to 158	
Temperature fluctuation	at 25 °C / 77 °F and 60% r.H.	± K	0.1	0.1	0.1	0,1
	at 40 °C / 104 °F and 75% r.H.	± K	0.1	0.1	0.1	0,1
Temperature uniformity (variation)	at 25 °C / 77 °F and 60% r.H.	± K	0.2	0.3	0.2	0,2
	at 40 °C / 104 °F and 75% r.H.	± K	0.2	0.3	0.2	0,2
Humidity range	% r.H.	10 to 80	10 to 80	10 to 80	10 to 80	
Humidity fluctuation	at 25 °C / 77 °F and 60% r.H.	± % r.H.	≤ 2	1.5	1.5	≤ 1,5
	at 40 °C / 104 °F and 75% r.H.	± % r.H.	≤ 2	1.5	1.5	≤ 1,5
Recovery time after doors were open for 30 sec.	at 25 °C / 77 °F and 60% r.H.	minutes	6	5	16	11
	at 40 °C / 104 °F and 75% r.H.	minutes	7	11	17	12
Electrical data (model versions KBF115-230V, KBF240-230V, KBF720-230V, KBF1020-230V)						
IP system of protection acc. to EN 60529			20	20	20	20
Nominal voltage (+/-10%)	at 50 Hz power frequency	V	200-230	200-230	200-230	200-230
	at 60 Hz power frequency	V	200-230	200-230	200-230	200-230
Current type			1N~	1N~	1N~	1N~
Power plug			shock proof plug			
Nominal power		kW	2.00	2.10	3.10	3.10
Installation category acc. to IEC 61010-1			II	II	II	II
Pollution degree acc. to IEC 61010-1			2	2	2	2
Over-current release category B, 2 poles		Amp	16	16	16	16

Chamber size			115	240	720	1020
Different electrical data for KBF constructed for the USA and Canada (model versions KBF115-240V, KBF240-240V, KBF720-240V, KBF1020-240V)						
Nominal voltage (+/-10%)	at 50 Hz power frequency	V	200-240	200-240	200-240	200-240
	at 60 Hz power frequency	V	200-240	200-240	200-240	200-240
Current type			2~	2~	2~	2~
Power plug		NEMA	6-20P	6-20P	6-20P	6-20P
Environment-specific data						
Noise level (mean value)		dB (A)	52	52	53	56
Energy consumption at 40 °C / 104 °F and 75 % r.H.		Wh/h	470	650	620	650
Filling weight of refrigerant R 134A (GWP 1300)		kg	0,180	0,170	0,380	0,410

All technical data is specified for unloaded chambers with standard equipment at an ambient temperature of +22 °C +/- 3°C / 71.6 °F ± 5.4 °F and a power supply voltage fluctuation of +/-10%. Technical data is determined in accordance to BINDER factory standard Part 2:2015 and DIN 12880:2007.

All indications are average values, typical for chambers produced in series. We reserve the right to change technical specifications at any time.

	If the chamber is fully loaded, the specified heating up and cooling down times may vary according to the load.
---	---

	Bringing a source of humidity into the inner chamber will affect the minimum humidity specification and may affect the humidity accuracy.
---	---

23.5 KMF technical data

Chamber size			115	240	720
Exterior dimensions					
Width, net	mm / inch	880 / 34.65	925 / 36.42	1250 / 49.21	
Height, gross (incl. feet/castors)	mm / inch	1050 / 41.34	1460 / 57.48	1925 / 75.79	
Depth, net	mm / inch	650 / 25.59	800 / 31.50	890 / 35.04	
Depth, gross(including door handle, I-triangle, connection, and 30 mm for cable)	mm / inch	730 / 28.74	880 / 34.65	970 / 38.19	
Wall clearance rear (minimum) (spacer)	mm / inch	100 / 3.94	100 / 3.94	100 / 3.94	
Wall clearance side (minimum)	mm / inch	100 / 3.94	100 / 3.94	100 / 3.94	
Doors					
Number of doors		1	1	2	
Number of inner glass doors		1	1	2	
Interior dimensions					
Width	mm / inch	600 / 23.62	650 / 25.60	973 / 38.31	
Height	mm / inch	483 / 19.02	785 / 30.91	1250 / 49.21	
Depth	mm / inch	351 / 13.82	485 / 19.09	576 / 22.68	
Interior volume	l / cu.ft.	102 / 3.6	247 / 8.7	700 / 24.7	
Steam space volume	l / cu.ft.	156 / 5.5	348 / 12.3	918 / 32.4	
Racks					
Quantity of racks (regular)		1	1	1	
Quantity of racks (max.)		5	9	15	
Maximum load per rack	kg / lbs.	30 / 66	30 / 66	45 / 99	
Maximum permitted total load	kg / lbs.	100 / 220	100 / 220	150 / 331	

Chamber size			115	240	720
Weight					
Weight (empty)	kg / lbs.		127 / 280	179 / 395	295 / 650
Temperature data (without humidity)					
Temperature range	°C / °F		-10 to +100 / 14 to 212	-10 to +100 / 14 to 212	-10 to +100 / 14 to 212
Average heating up time acc. to IEC 60068-3-5	K/min.		1.3	0.8	0.7
Average cooling down time acc. to IEC 60068-3-5	K/min.		0.5	0.4	0.4
Heating up time from -10 °C / 14 °F to +100 °C / 212 °F	minutes		85	140	155
Cooling down time from +100 °C / 212 °F to -10 °C / 14 °F	minutes		240	360	350
Max. heat compensation at 25 °C / 77 °F	W		150	200	450
Climatic data (with humidity)					
Temperature range	°C / °F		+10 to +90 / 50 to 194	+10 to +90 / 50 to 194	+10 to +90 / 50 to 194
Temperature fluctuation *)	± K		0.1 to 0.3	0.1 to 0.3	0.1 to 0.5
Temperature uniformity (variation) *)	± K		0.2 to 1.0	0.1 to 1.0	0.1 to 1.0
Humidity range	% r.H.		10 to 98	10 to 98	10 to 98
Humidity fluctuation *)	± % r.H.		≤ 2,5	≤ 2	≤ 2
Dew point temperature range	°C		+5 to +90	+5 to +90	+5 to +90
Electrical data (model versions KMF115-230V, KMF240-230V, KMF720-230V)					
IP system of protection acc. to EN 60529			20	20	20
Nominal voltage (+/-10%)	at 50 Hz power frequency	V	200-230	200-230	200-230
	at 60 Hz power frequency	V	200-230	200-230	200-230
Current type			1N~	1N~	1N~
Power plug			Shock-proof plug		
Nominal power	kW		2.00	2.10	3.10
Installation category acc. to IEC 61010-1			II	II	II
Pollution degree acc. to IEC 61010-1			2	2	2
Over-current release category B, 2 poles	Amp		16	16	16
Deviant electrical data KMF for the USA and Canada (model versions KMF115-240V, KMF240-240V, KMF720-240V)					
Nominal voltage (+/-10%)	at 50 Hz power frequency	V	200-240	200-240	200-240
	at 60 Hz power frequency	V	200-240	200-240	200-240
Current type			2~	2~	2~
Power plug	NEMA		6-20P	6-20P	6-20P
Environment-specific data					
Noise level (mean value)	dB (A)		52	52	56
Energy consumption at 85 °C / 185 °F and 85 % r.H.	Wh/h		570	570	900
Filling weight of refrigerant R 134A (GWP 1300)	kg		0.180	0.240	0.430

*) Depending on the set-point.

All technical data is specified for unloaded chambers with standard equipment at an ambient temperature of +22 °C +/- 3°C / 71.6 °F ± 5.4 °F and a power supply voltage fluctuation of +/-10%. Technical data is determined in accordance to BINDER factory standard Part 2:2015 and DIN 12880:2007.

All indications are average values, typical for chambers produced in series. We reserve the right to change technical specifications at any time.

	Refrigerating performance decreases while operating the chamber at temperatures < 0 °C / 32 °F due to icing of the evaporators. For this reason defrost the chamber regularly, e.g. once a week.
---	--

	If the chamber is fully loaded, the specified heating up and cooling down times may vary according to the load.
---	---

	Bringing a source of humidity into the inner chamber will affect the minimum humidity specification and may affect the humidity accuracy.
---	---

23.6 Equipment and options (extract)

	To operate the constant climate chamber, use only original BINDER accessories or accessories / components from third-party suppliers authorized by BINDER. The user is responsible for any risk arising from using unauthorized accessories.
---	--

Regular equipment

Microprocessor display program controller with 2-channel technology for temperature and humidity

Ethernet interface for computer communication

Temperature safety device class 3.1 acc. to DIN 12880:2007

Inner glass door with gasket

DCT™ refrigerating system with refrigerant R134a

Microprocessor controlled humidifying and dehumidifying system *) (humidity range, see diagram)

Sizes 240, 720 and 1020: Four castors (2 lockable)

1 rack (KMF), 2 racks (KBF), stainless steel

Access port 30 mm with silicone plug

*) A water supply (1 to 10 bar) is necessary for the installation of the humidifying and de-humidifying system (chap. 4.3). If no suitable house water connection is available, you can manually supply water by filling a freshwater can (option, chap. 19.9). Furthermore, a water drain in a max. distance of 3 meters / 9.8 ft. and a max. height of 1 meter / 3.3 ft. is required (chap. 4.2).

Options / accessories

Additional rack, stainless steel

Perforated shelf, stainless steel

Reinforced rack with rack lockings

Securing elements for additional fastening of racks (4 pieces)

KMF: Reinforced inner chamber with 2 reinforced racks

Temperature safety device class 3.3 acc. to DIN 12880

Zero-voltage relay alarm outputs for temperature and humidity with DIN plug 6-poles

Lockable door

Access ports 30 mm or 50 mm or 100 mm with silicone plug

Analog outputs 4-20 mA for temperature and humidity with 6 pole DIN socket, DIN plug included

Flexible Pt 100 temperature sensor, output to DIN socket (BINDER INDIVIDUAL customized solutions)

Object temperature display with flexible Pt 100 temperature sensor

Communication interface RS422

BINDER Data Logger kit for temperature / humidity: TH 100 (chamber values) or TH 100/70 (chamber and ambient values)

Options / accessories (continued)
External freshwater and wastewater cans (20 liters / 0.71 cu.ft. each)
BINDER Pure Aqua Service
Exchange cartridge for BINDER Pure Aqua Service
Safety kit for water connection with hose burst protection device and reflux protection device, pre-mounted assembly (BINDER INDIVIDUAL customized solutions)
KBF: Voltage changer for operation at 115 Volt
KBF: Water protected internal socket 230 V AC
Calibration of temperature and humidity including certificate
Spatial temperature and humidity measurement including certificate
Spatial temperature and humidity measurement acc. to DIN 12880:2007 including certificate
Qualification folder

23.7 Spare parts and accessories (extract)

	BINDER GmbH is responsible for the safety features of the chamber only, provided skilled electricians or qualified personnel authorized by BINDER perform all maintenance and repair, and if components relating to chamber safety are replaced in the event of failure with original spare parts. The user is responsible for any risks arising from using unauthorized accessories/components.
---	--

Chamber size	115	240	720	1020
Description	Art. no.			
Rack, stainless steel	6004-0112	6004-0101	6004-0106	6004-0143
Perforated rack, stainless steel	6004-0115	6004-0040	8009-0486	8009-0792
Reinforced rack with rack lockings	8012-0700	8012-0638	8012-0674	8012-0968
Securing elements for additional fastening of racks (4 pieces)	8012-0620	8012-0620	8012-0620	8012-0620
Door gasket for glass door	6005-0204	6005-0149	6005-0198	6005-0198
Door gasket silicone (kettle)	6005-0207	6005-0147	6005-0196	6005-0196
Door gasket silicone (outer door)	6005-0203	6005-0161	6005-0197	6005-0197
Intermediate door gasket, silicone	---	---	6005-0192	6005-0250

Description	Art. no.
Plug for silicon access port d30	6016-0035
Radial fan 200-240V / 50/60 Hz	5013-0088
External freshwater and wastewater cans (20 liters / 0.71 cu.ft. each)	8012-0643
BINDER Pure Aqua Service	8012-0759
Exchange cartridge for BINDER Pure Aqua Service	6011-0165
Safety kit for water connection with hose burst protection device and reflux protection device	BINDER Individual
Voltage changer for operation at 115 Volt (for KBF)	8009-0821
MB2 program controller, screen with E/A board	5014-0197
Temperature safety device, class 1 (complete)	8009-0335
Temperature safety device class 3.1, 0 °C / 32 °F to 120 °C / 248 °F	5006-0035
Temperature safety device class 3.2, -40 °C / -40 °F to 160 °C / 320 °F	5006-0026
Temperature sensor 2x Pt 100 straight	5002-0050
Humidity sensor (KBF)	5002-0071
Humidity sensor (KMF)	5002-0052

Description	Art. no.
Data Logger Kit TH 70	8012-0716
Data Logger Kit TH 70/70	8012-0717
Data Logger Kit TH 100	8012-0718
Data Logger Kit TH 100/70	8012-0719
Door switch	5019-0061
Humidification module	8009-0789
Neutral cleaning agent, 1 kg	1002-0016
Validation service	
Qualification folder IQ-OQ (KBF)	8012-0867
Qualification folder IQ-OQ (KMF)	8012-0879
Qualification folder IQ-OQ-PQ (KBF)	8012-0955
Qualification folder IQ-OQ-PQ (KMF)	8012-0966
Execution of IQ-OQ	DL420300
Execution of IQ-OQ-PQ	DL440500
Calibration service	
Calibration of temperature and humidity including certificate (1 measuring point)	DL300301
Spatial temperature and humidity measurement including certificate (9 measuring points temperature, 1 measuring point humidity)	DL300309
Spatial temperature and humidity measurement including certificate (18 measuring points temperature, 1 measuring point humidity)	DL300318
Spatial temperature and humidity measurement including certificate (27 measuring points temperature, 1 measuring point humidity)	DL300327

23.8 Dimensions size 115

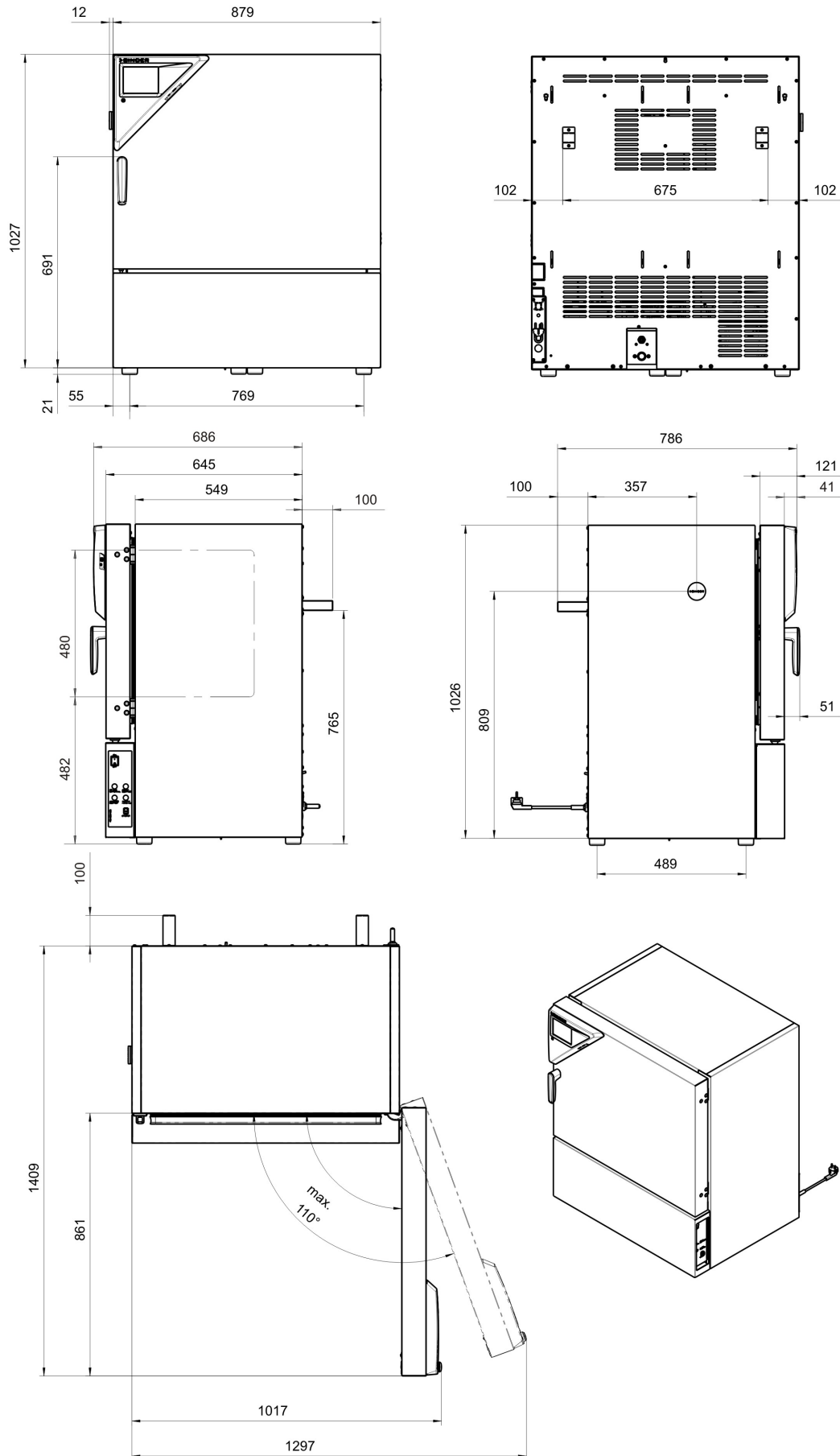

23.9 Dimensions size 240

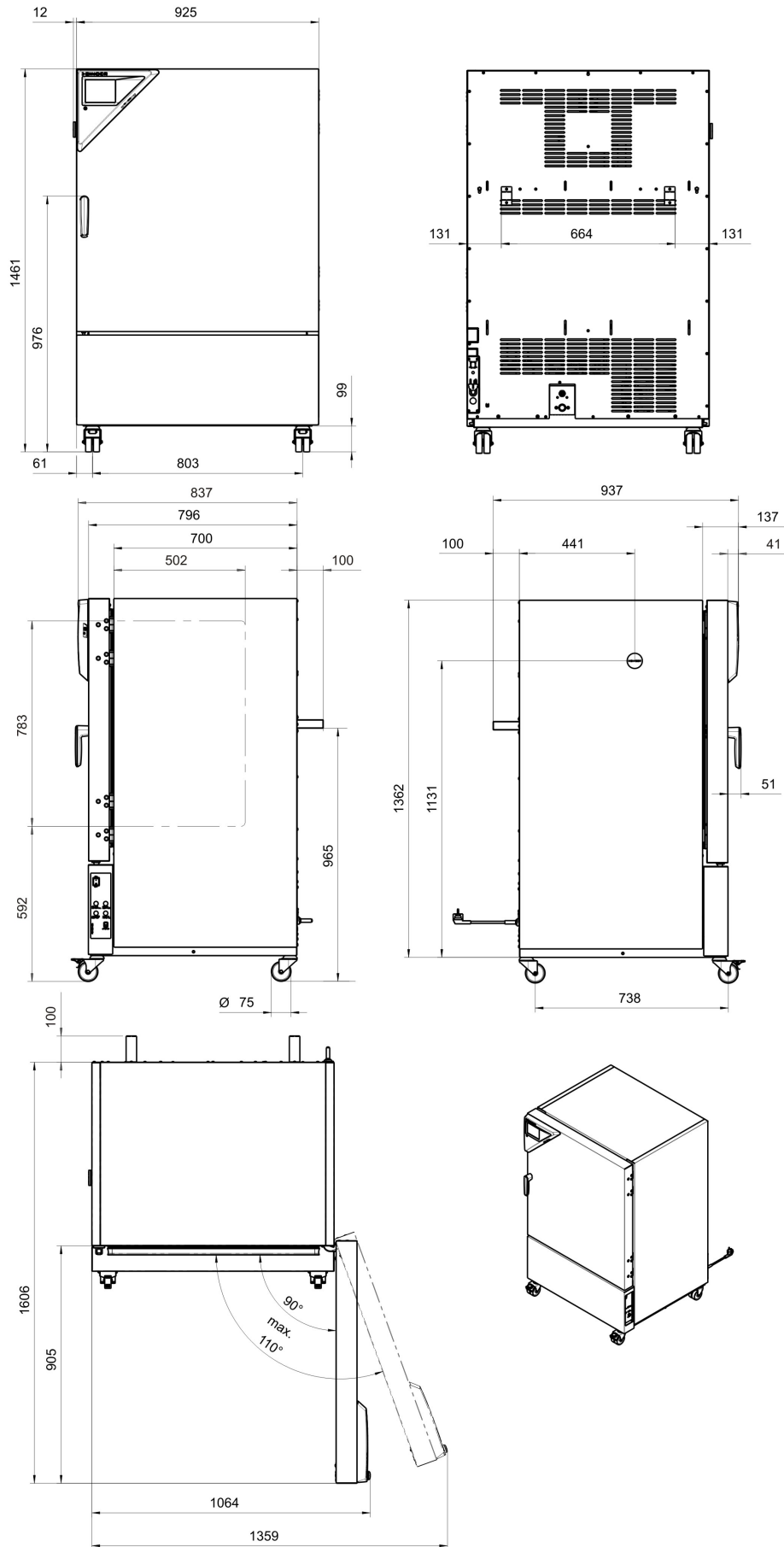

23.10 Dimensions size 720

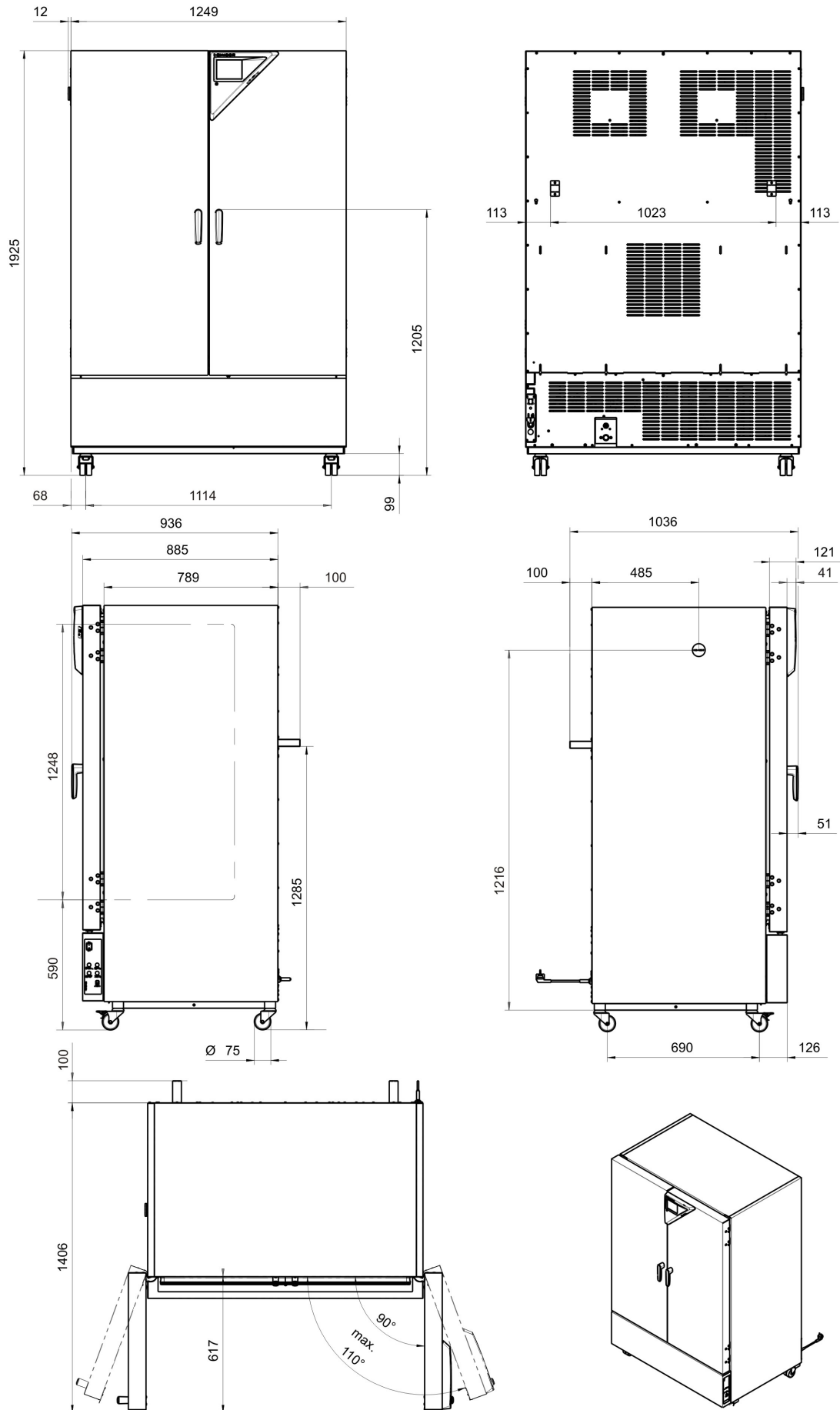

23.11 Dimensions size 1020

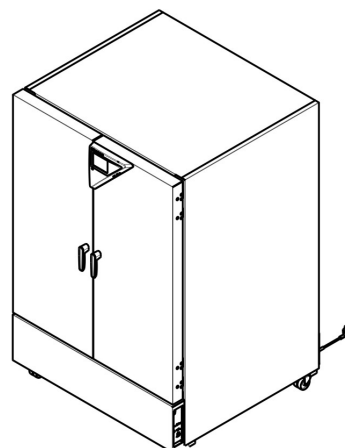
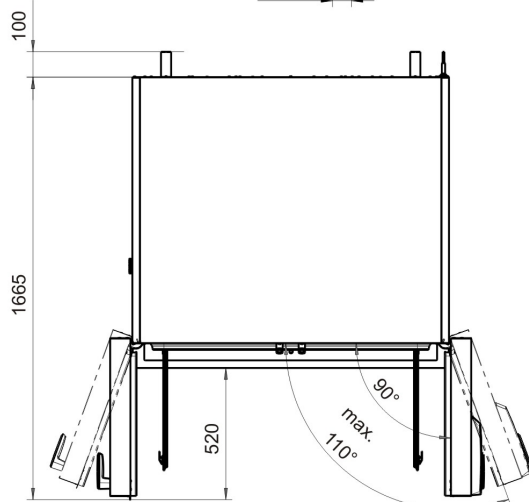
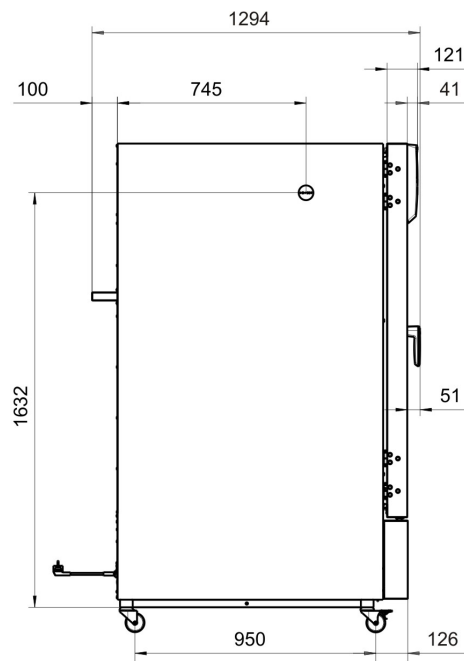
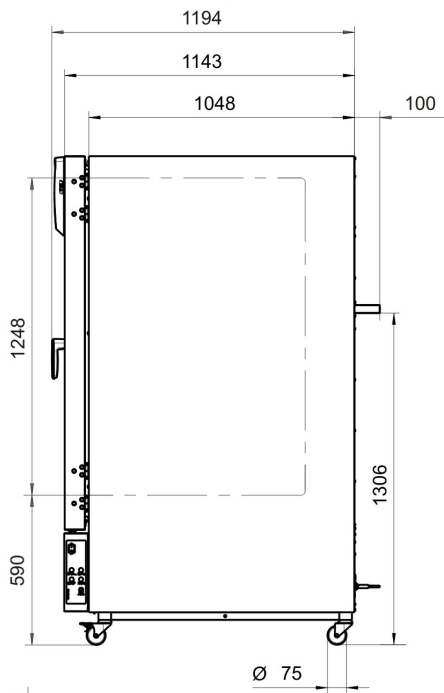
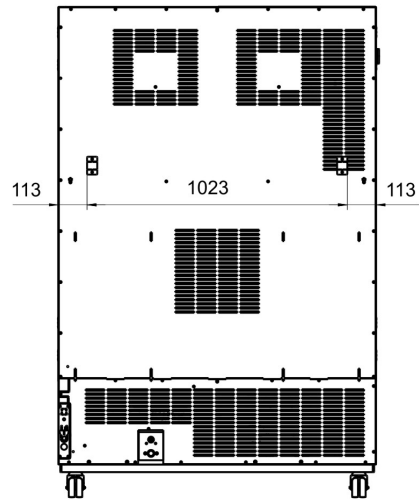
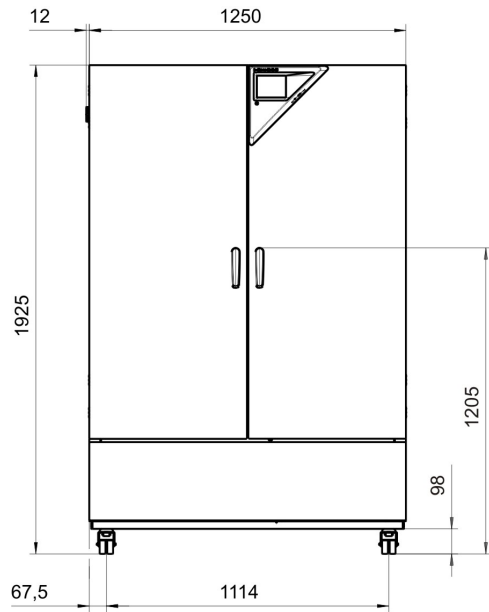

24. Certificates and declarations of conformity

24.1 EU Declaration of Conformity for KBF



Best conditions for your success

	EU-Konformitätserklärung / EU Declaration of Conformity / Déclaration de conformité UE / Declaración de conformidad UE / Dichiarazione di conformità UE / Декларация соответствия EU
Hersteller / Manufacturer / Fabricant / Fabricante / Fabbricante / Производитель	BINDER GmbH
Anschrift / Address / Adresse / Dirección / Indirizzo / Адрес	Im Mittleren Ösch 5, 78532 Tuttlingen, Germany
Produkt / Product / Produit / Producto / Prodotto / Продукт	Wechselklimaschränke Alternating climate chambers Enceintes climatiques pour des conditions variables Cámaras de clima alternante Camere per condizioni climatiche con alternanza Камеры моделирования условий окружающей среды для сложных температурных условий
Typenbezeichnung / Type / Type / Tipo / Tipo / Тип	KBF 115, KBF 240, KBF 720, KBF 1020

Die oben beschriebenen Maschinen sind konform mit folgenden EG/EU-Richtlinien (gemäß Veröffentlichung im Amtsblatt der europäischen Kommission):

The machines described above are in conformity with the following EC/EU Directives (as published in the Official Journal of the European Union):

Les machines décrites ci-dessus sont conformes aux directives CE/UE suivantes (selon leur publication dans le Journal officiel de l'Union européenne):

La máquina descrita arriba cumple con las siguientes directivas de la CE/UE (publicados en el Diario oficial de la Unión Europea):

Le macchine sopra descritte sono conforme alle seguenti direttive CE/UE (secondo la pubblicazione nella Gazzetta ufficiale della Commissione europea):

Машина, указанная выше, полностью соответствует следующим регламентам ЕС/ЕУ (опубликованным в Официальном журнале Европейского Содружества):

- **2006/42/EC**
 Maschinenrichtlinie 2006/42/EG / Machinery directive 2006/42/EC / Directive Machines 2006/42/EC / Directiva 2006/42/CE (Máquinas) / Direttiva macchine 2006/42/CE / Директива о машинах 2006/42/EC
- **2014/30/EU**
 EMV-Richtlinie 2014/30/EU / EMC Directive 2014/30/EU / Directive CEM 2014/30/UE / Directiva CEM 2014/30/UE / Direttiva EMC 2014/30/UE / Директива ЭМС 2014/30/EU

Die oben beschriebenen Maschinen entsprechen aufgrund ihrer Konzipierung und Bauart sowie in der von uns in Verkehr gebrachten Ausführung den einschlägigen grundlegenden Sicherheits- und Gesundheitsanforderungen der genannten EG/EU-Richtlinien.

The machines described above are conform to the mentioned EC/EU directives in regard to the relevant safety and health demands due to their conception and style of construction as well as to the version put onto market by us.

Les machines décrites ci-dessus correspondent aux demandes de sécurité et de santé des directives citées de la CE/UE due à leur conception et construction et dans la réalisation mise sur le marché par nous.

Las máquinas descritas arriba se corresponden con los requisitos básicos pertinentes de seguridad y salud de las citadas directivas de la CE/UE debido a su concepción y fabricación, así como a la realización llevada a cabo por nosotros.

Le macchine sopra descritte sono conforme ai requisiti essenziali di sanità e sicurezza pertinenti delle summenzionate direttive CE/UE in termini di progettazione, tipo di costruzione ed esecuzione messa da noi in circolazione.

Машины описано выше, соответствует указанным директивам ЕС/ЕУ в отношении требований соответствующей безопасности и здоровья по концепции и конструкции так же как и версия, применяемая нами на рынке.

1 / 2

BINDER GmbH Postfach 102 D-78502 Tuttlingen **Hausanschrift:** BINDER GmbH Im Mittleren Ösch 5 D-78532 Tuttlingen
Kontakt: Telefon: +49 (0) 74 62 / 20 05 - 0 | Telefax: +49 (0) 74 62 / 20 05 - 100 | info@binder-world.com | www.binder-world.com
Geschäftsführung: Dipl.-Ing. Peter M. Binder | Amtsgericht Tuttlingen, HRB 385 Tu. | Sitz der Gesellschaft: Tuttlingen
Bankverbindung: Kreissparkasse Tuttlingen Konto-Nr.: 2266 BLZ: 643 500 70 | IBAN-Code: DE05643 500700 00002266 | SWIFT-Code: SOLA DE 31TUT
 Deutsche Bank Tuttlingen Konto-Nr.: 2 138 709 BLZ: 653 700 75 | IBAN-Code: DE56653 70075 0213870900 | SWIFT-Code: DEUT DE 55603

Die oben beschriebenen Maschinen tragen entsprechend die Kennzeichnung CE.
The machines described above, corresponding to this, bear the CE-mark.
Les machines décrits ci-dessus, en correspondance, portent l'indication CE.
Las maquinas descritas arriba, en conformidad, llevan la indicación CE.
Le macchine sopra descritte sono contrassegnate dal marchio CE.
Машины описано выше, в соответствии с изложенным выше маркированы знаком CE.

Die oben beschriebenen Maschinen sind konform mit folgenden harmonisierten Normen:
The machines described above are in conformity with the following harmonized standards:
Les machines décrits ci-dessus sont conformes aux normes harmonisées suivantes:
Las maquinas descritas arriba cumplen con las siguientes normas:
Le macchine sopra descritte sono conforme alle seguenti normative armonizzate:
Машины описано выше, полностью соответствуют следующим стандартам:

Sicherheit / Safety / Sécurité / Seguridad / Sicurezza / Нормативы по безопасности
<ul style="list-style-type: none">• EN ISO 12100:2010 + Corr. 1:2011• EN ISO 13732-1:2008• EN 60204-1:2006 + A1:2009 + Corr. :2010
EMV / EMC / CEM / CEM / EMC / ЭМС
<ul style="list-style-type: none">• EN 61326-1:2013

78532 Tuttlingen, 20.07.2016
BINDER GmbH



P. M. Binder
Geschäftsführender Gesellschafter
Managing Director
Directeur général
Director general
Direttore Generale
Директор

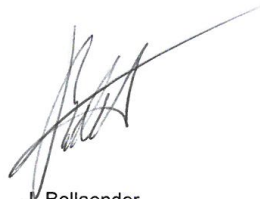

J. Bollaender
Leiter F & E und Dokumentationsbevollmächtigter
Director R & D and documentation representative
Chef de service R&D et autorisé de documentation
Responsable I & D y representante de documentación
Direttore R & D e responsabile della documentazione
Глава департамента R&D представитель документации

2 / 2

24.2 EU Declaration of Conformity for KMF



Best conditions for your success

	EU-Konformitätserklärung / EU Declaration of Conformity / Déclaration de conformité UE / Declaración de conformidad UE / Dichiarazione di conformità UE / Декларация соответствия EU
Hersteller / Manufacturer / Fabricant / Fabricante / Fabbicante / Производитель	BINDER GmbH
Anschrift / Address / Adresse / Dirección / Indirizzo / Адрес	Im Mittleren Ösch 5, 78532 Tuttlingen, Germany
Produkt / Product / Produit / Producto / Prodotto / Продукт	Wechselklimaschränke Alternating climate chambers Enceintes climatiques pour des conditions variables Cámaras de clima alternante Camere per condizioni climatiche con alternanza Камеры моделирования условий окружающей среды для сложных температурных условий
Typenbezeichnung / Type / Type / Tipo / Tipo / Тип	KMF 115, KMF 240, KMF 720

Die oben beschriebenen Maschinen sind konform mit folgenden EG/EU-Richtlinien (gemäß Veröffentlichung im Amtsblatt der europäischen Kommission):

The machines described above are in conformity with the following EC/EU Directives (as published in the Official Journal of the European Union):

Les machines décrites ci-dessus sont conformes aux directives CE/UE suivantes (selon leur publication dans le Journal officiel de l'Union européenne):

La máquina descrita arriba cumple con las siguientes directivas de la CE/UE (publicados en el Diario oficial de la Unión Europea):

Le macchine sopra descritte sono conforme alle seguenti direttive CE/UE (secondo la pubblicazione nella Gazzetta ufficiale della Commissione europea):

Машина, указанная выше, полностью соответствует следующим регламентам ЕС/ЕУ (опубликованным в Официальном журнале Европейского Содружества):

- **2006/42/EC**
 Maschinenrichtlinie 2006/42/EG / Machinery directive 2006/42/EC / Directive Machines 2006/42/EC / Directiva 2006/42/CE (Máquinas) / Direttiva macchine 2006/42/CE / Директива о машинах 2006/42/EC
- **2014/30/EU**
 EMV-Richtlinie 2014/30/EU / EMC Directive 2014/30/EU / Directive CEM 2014/30/UE / Directiva CEM 2014/30/UE / Direttiva EMC 2014/30/UE / Директива ЭМС 2014/30/EU

Die oben beschriebenen Maschinen entsprechen aufgrund ihrer Konzipierung und Bauart sowie in der von uns in Verkehr gebrachten Ausführung den einschlägigen grundlegenden Sicherheits- und Gesundheitsanforderungen der genannten EG/EU-Richtlinien.

The machines described above are conform to the mentioned EC/EU directives in regard to the relevant safety and health demands due to their conception and style of construction as well as to the version put onto market by us.

Les machines décrites ci-dessus correspondent aux demandes de sécurité et de santé des directives citées de la CE/UE due à leur conception et construction et dans la réalisation mise sur le marché par nous.

Las máquinas descritas arriba se corresponden con los requisitos básicos pertinentes de seguridad y salud de las citadas directivas de la CE/UE debido a su concepción y fabricación, así como a la realización llevada a cabo por nosotros.

Le macchine sopra descritte sono conforme ai requisiti essenziali di sanità e sicurezza pertinenti delle summenzionate direttive CE/UE in termini di progettazione, tipo di costruzione ed esecuzione messa da noi in circolazione.

Машины описано выше, соответствует указанным директивам ЕС/ЕУ в отношении требований соответствующей безопасности и здоровья по концепции и конструкции так же как и версия, применяемая нами на рынке.

1 / 2

BINDER GmbH Postfach 102 D-78502 Tuttlingen **Hausanschrift:** BINDER GmbH Im Mittleren Ösch 5 D-78532 Tuttlingen
Kontakt: Telefon: +49 (0) 74 62 / 20 05 - 0 | Telefax: +49 (0) 74 62 / 20 05 - 100 | info@binder-world.com | www.binder-world.com
Geschäftsführung: Dipl.-Ing. Peter M. Binder | Amtsgericht Tuttlingen, HRB 385 Tu. | Sitz der Gesellschaft: Tuttlingen
Bankverbindung: Kreissparkasse Tuttlingen Konto-Nr.: 2266 BLZ: 643 500 70 | IBAN-Code: DE05643 500700 000002266 | SWIFT-Code: SOLA DE S1TUT
 Deutsche Bank Tuttlingen Konto-Nr.: 2 138 709 BLZ: 653 700 75 | IBAN-Code: DE56653 70075 0213870900 | SWIFT-Code: DEUT DE SS603

Die oben beschriebenen Maschinen tragen entsprechend die Kennzeichnung CE.

The machines described above, corresponding to this, bear the CE-mark.

Les machines décrits ci-dessus, en correspondance, portent l'indication CE.

Las maquinas descritas arriba, en conformidad, llevan la indicación CE.

Le macchine sopra descritte sono contrassegnate dal marchio CE.

Машины описано выше, в соответствии с изложенным выше маркированы знаком CE.

Die oben beschriebenen Maschinen sind konform mit folgenden harmonisierten Normen:

The machines described above are in conformity with the following harmonized standards:

Les machines décrits ci-dessus sont conformes aux normes harmonisées suivantes:

Las maquinas descritas arriba cumplen con las siguientes normas:

Le macchine sopra descritte sono conforme alle seguenti normative armonizzate:

Машины описано выше, полностью соответствуют следующим стандартам:

Sicherheit / Safety / Sécurité / Seguridad / Sicurezza / Нормативы по безопасности
<ul style="list-style-type: none">• EN ISO 12100:2010 + Corr. 1:2011• EN ISO 13732-1:2008• EN 60204-1:2006 + A1:2009 + Corr. :2010
EMV / EMC / CEM / CEM / EMC / ЭМС
<ul style="list-style-type: none">• EN 61326-1:2013

78532 Tuttlingen, 20.07.2016

BINDER GmbH



P. M. Binder
Geschäftsführender Gesellschafter
Managing Director
Directeur général
Director general
Direttore Generale
Директор



J. Bollaender
Leiter F & E und Dokumentationsbevollmächtigter
Director R & D and documentation representative
Chef de service R&D et autorisé de documentation
Responsable I & D y representante de documentación
Direttore R & D e responsabile della documentazione
Глава департамента R&D представитель документации

2 / 2

24.3 Certificate for the GS mark of conformity of the “Deutsche Gesetzliche Unfallversicherung e.V.“ (German Social Accident Insurance) DGUV

Bescheinigung
Nr. **NV 15127**
vom 17.06.2015

 **DGUV Test**
Prüf- und Zertifizierungsstelle
Nahrungsmittel und Verpackung
Fachbereich Nahrungsmittel

GS-Zertifikat

Name und Anschrift des Bescheinigungsinhabers: (Auftraggeber)	Binder GmbH Im Mittleren Ösch 5 78532 Tuttlingen
Produktbezeichnung:	Klimaschränke Klima- und Kühlbrutschränke
Typ:	KBF P 240, KBF P 720, KBF LQC 240, KBF LQC 720, KBWF 240, KBWF 720, KBF 115, KBF 240, KBF 720, KMF 115, KMF 240, KMF 720, KBW 240, KBW 400, KBW 720, KB 23, KB 53, KB 115, KB 240, KB 400, KB 720, KBF 1020
Prüfgrundlage:	GS-NV 5:2013/06 Prüfgrundsätze für Kühl- und Gefriermaschinen für Industrie und Gewerbe
Zugehöriger Prüfbericht:	NV 15127
Weitere Angaben:	Das Zertifikat bezieht sich auf die im zugehörigen Prüfbericht beschriebene Ausführung des Produkts.

Das geprüfte Baumuster stimmt mit den in § 21 Absatz 1 des Produktsicherheitsgesetzes genannten Anforderungen überein. Der Bescheinigungsinhaber ist berechtigt, das umseitig abgebildete GS-Zeichen an den mit dem geprüften Baumuster übereinstimmenden Produkten anzubringen. Der Bescheinigungsinhaber hat dabei die umseitig aufgeführten Bedingungen zu beachten.

Diese Bescheinigung einschließlich der Berechtigung zur Anbringung des GS-Zeichens ist gültig bis:
16.06.2020

Weiteres über die Gültigkeit, eine Gültigkeitsverlängerung und andere Bedingungen regelt die Prüf- und Zertifizierungsordnung.



PZB04_D
11.14

Deutsche Gesetzliche Unfallversicherung (DGUV) e.V.
Spitzenverband der gewerblichen Berufsgenossenschaften
und der Unfallversicherungsträger der öffentlichen Hand
Vereinsregister-Nr. VR 751 B, Amtsgericht Charlottenburg

DGUV Test Prüf- und Zertifizierungsstelle Nahrungsmittel und Verpackung
Fachbereich Nahrungsmittel
Dynamostraße 7 – 11 • 68165 Mannheim • Deutschland
Telefon: +49 (0) 6 21 44 56-34 30 • Fax: +49 (0) 800 1977 553 16625

Rückseite GS-Zertifikat: NV 15127

GS-Zeichen

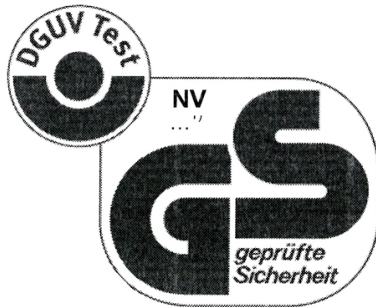

Normalausführung

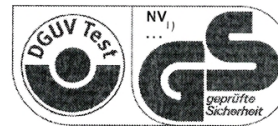

Bei einer Höhe von 20 mm oder weniger
auch zulässige Ausführung

1)Bescheinigungs-Nummer

1. Der Bescheinigungsinhaber hat die Voraussetzungen einzuhalten, die bei der Herstellung des umseitig genannten Produktes zu beachten sind, um die Übereinstimmung mit dem geprüften Baumuster zu gewährleisten.
2. Die Prüf- und Zertifizierungsstelle des Fachbereichs Nahrungsmittel führt in regelmäßigen Abständen Kontrollmaßnahmen zur Überwachung der Herstellung und rechtmäßigen Verwendung des GS-Zeichens durch.
3. Die für die Herstellung verantwortliche Person hat sich zur Einhaltung der Voraussetzungen nach Nummer 1 und Duldung der Kontrollmaßnahmen verpflichtet.
4. Die Prüf- und Zertifizierungsstelle entzieht dem Bescheinigungsinhaber die Zuerkennung des GS-Zeichens, wenn sich die Anforderungen nach § 21 Absatz 1 Produktsicherheitsgesetz geändert haben oder die Voraussetzungen nach Nummer 1 nicht eingehalten werden.
5. Das GS-Zeichen darf nur verwendet und mit ihm darf nur geworben werden, wenn die Voraussetzungen nach § 22 Produktsicherheitsgesetz erfüllt sind.

25. Product registration

Online Product Registration

Register your BINDER now!

www.binder-world.com/register

The registration is free and takes just a few seconds

Advantages:

- ▶ Short response times if service is needed
- ▶ Fair prices when relocating or installing equipment
- ▶ Calibration as required at no charge in case of recalls
- ▶ Free information on news, product upgrades and accessories

Easy registered in 3 steps:



1. List serial number here:

□□-□□□□□□

2. Go online: www.binder-world.com/register

3. Register serial number

26. Contamination clearance certificate

26.1 For chambers located outside USA and Canada

Declaration regarding safety and health

Erklärung zur Sicherheit und gesundheitlichen Unbedenklichkeit

The German Ordinance on Hazardous Substances (GefStofV), and the regulations regarding safety at the workplace, require that this form be filled out for all products that are returned to us, so that the safety and the health of our employees can be guaranteed

Die Sicherheit und Gesundheit unserer Mitarbeiter, die Gefahrstoffverordnung GefStofV und die Vorschriften zur Sicherheit am Arbeitsplatz machen es erforderlich, dass dieses Formblatt für alle Produkte, die an uns zurückgeschickt werden, ausgefüllt wird.



Note: A repair is not possible without a completely filled out form.
Ohne Vorliegen des vollständig ausgefüllten Formblattes ist eine Reparatur nicht möglich.

- A completely filled out form must be transmitted via Fax (+49 (0) 7462 2005 93555) or by letter in advance, so that this information is available before the equipment/component part arrives. A second copy of this form must accompany the equipment/component part. In addition, the carrier should be notified.

Eine vollständig ausgefüllte Kopie dieses Formblattes soll per Fax unter Nr. +49 (0) 7462 2005 93555 oder Brief vorab an uns gesandt werden, so dass die Information vorliegt, bevor das Gerät/Bauteil eintrifft. Eine weitere Kopie soll dem Gerät/Bauteil beigelegt sein. Ggf. ist die Spedition zu informieren.

- Incomplete information or non-conformity with this procedure will inevitably lead to substantial delays in processing. Please understand the reason for this measure, which lies outside our area of influence, and will help us to speed up this procedure.

Unvollständige Angaben oder Nichteinhalten dieses Ablaufs führen zwangsläufig zu beträchtlichen Verzögerungen in der Abwicklung. Bitte haben Sie Verständnis für Maßnahmen, die außerhalb unserer Einflussmöglichkeiten liegen und helfen Sie mit, den Ablauf zu beschleunigen.

- **Please print and fill out this form completely**

Bitte unbedingt vollständig ausfüllen!

1.	Unit/ component part / type / Gerät / Bauteil / Typ:
2.	Serial No. / Serien-Nr.:
3.	Details about utilized substances / biological substances / Einzelheiten über die eingesetzten Substanzen/biologische Materialien:
3.1	Designations / Bezeichnungen:
a)	_____
b)	_____
c)	_____
3.2	Safety measures required for handling these substances / Vorsichtsmaßnahmen beim Umgang mit diesen Stoffen:
a)	_____
b)	_____
c)	_____

3.3 Measures to be taken in case of skin contact or release into the atmosphere / Maßnahmen bei Personenkontakt oder Freisetzung:
a) _____
b) _____
c) _____
d) _____
3.4 Other important information that must be taken into account / Weitere zu beachtende und wichtige Informationen:
a) _____
b) _____
c) _____
4. Declaration on the risk of these substances (please checkmark the applicable items) / Erklärung zur Gefährlichkeit der Stoffe (bitte Zutreffendes ankreuzen) :
<input type="checkbox"/> 4.1 For non toxic, non radioactive, biologically harmless materials / für nicht giftige, nicht radioaktive, biologisch ungefährliche Stoffe:
We hereby guarantee that the above-mentioned unit / component part... / Wir versichern, dass o.g. Gerät/Bauteil...
<input type="checkbox"/> Has not been exposed to or contains any toxic or otherwise hazardous substances / weder giftige noch sonstige gefährliche Stoffe enthält oder solche anhaften.
<input type="checkbox"/> That eventually generated reaction products are non-toxic and also do not represent a hazard / auch evtl. entstandene Reaktionsprodukte weder giftig sind noch sonst eine Gefährdung darstellen.
<input type="checkbox"/> Eventual residues of hazardous substances have been removed / evtl. Rückstände von Gefahrstoffen entfernt wurden.
<input type="checkbox"/> 4.2 For toxic, radioactive, biologically harmful or hazardous substances, or any other hazardous materials / für giftige, radioaktive, biologisch bedenkliche bzw. gefährliche Stoffe oder anderweitig gefährliche Stoffe.
We hereby guarantee that ... / Wir versichern, dass ...
<input type="checkbox"/> The hazardous substances, which have come into contact with the above-mentioned equipment / component part, have been completely listed under item 3.1 and that all information in this regard is complete / die gefährlichen Stoffe, die mit dem o.g. Gerät/Bauteil in Kontakt kamen, in 3.1 aufgelistet sind und alle Angaben vollständig sind.
<input type="checkbox"/> That the unit /component part has not been in contact with radioactivity / das Gerät/Bauteil nicht mit Radioaktivität in Berührung kam
5. Kind of transport / transporter / Transportweg/Spediteur:
Transport by (means and name of transport company, etc.) Versendung durch (Name Spediteur o.ä.)

Date of dispatch to BINDER GmbH / Tag der Absendung an BINDER GmbH:

We hereby declare that the following measures have been taken / Wir erklären, dass folgende Maßnahmen getroffen wurden:

- Hazardous substances were removed from the unit including component parts, so that no hazard exists for any person in the handling or repair of these items / das Gerät/Bauteil wurde von Gefahrstoffen befreit, so dass bei Handhabung/Reparaturen für die betreffenden Person keinerlei Gefährdung besteht
- The unit was securely packaged and properly identified / das Gerät wurde sicher verpackt und vollständig gekennzeichnet.
- Information about the hazardousness of the shipment (if required) has been provided to the transporter / der Spediteur wurde (falls vorgeschrieben) über die Gefährlichkeit der Sendung informiert.

We hereby commit ourselves and guarantee that we will indemnify BINDER GmbH for all damages that are a consequence of incomplete or incorrect information provided by us, and that we will exempt BINDER GmbH from eventual damage claims by third parties./ Wir versichern, dass wir gegenüber BINDER für jeden Schaden, der durch unvollständige und unrichtige Angaben entsteht, haften und BINDER gegen eventuell entstehende Schadenansprüche Dritter freistellen.

We are aware that, in accordance with Article 823 of the German Civil Code (BGB), we are directly liable with regard to third parties, in this instance especially the employees of BINDER GmbH, who have been entrusted with the handling / repair of the unit / component. / Es ist uns bekannt, dass wir gegenüber Dritten – hier insbesondere mit der Handhabung/Reparatur des Geräts/des Bauteils betraute Mitarbeiter der Firma BINDER – gemäß §823 BGB direkt haften

Name: _____

Position/ Title: _____

Date / Datum: _____

Signature / Unterschrift: _____

Company stamp / Firmenstempel:



Equipment that is returned to the factory for repair must be accompanied by a completely filled out contamination clearance certificate. For service and maintenance on site, such a contamination clearance certificate must be submitted to the service technician before the start of any work. No repair or maintenance of the equipment is possible, without a properly filled out contamination clearance certificate.

26.2 For chambers located in USA and Canada

Product Return Authorization Request

Please complete this form and the Customer Decontamination Declaration (next 2 pages) and attach the required pictures. E-mail to: IDL_SalesOrderProcessing_USA@binder-world.com

After we have received and reviewed the complete information we will decide on the issue of a RMA number. Please be aware that size specifications, voltage specifications as well as performance specifications are available on the internet at www.binder-world.us at any time.

Take notice of shipping laws and regulations.

	Please fill:	
Reason for return request	<input type="radio"/> Duplicate order	
	<input type="radio"/> Duplicate shipment	
	<input type="radio"/> Demo	<i>Page one completed by sales</i>
	<input type="radio"/> Power Plug / Voltage	115V / 230 V / 208 V / 240V
	<input type="radio"/> Size does not fit space	
	<input type="radio"/> Transport Damage	Shock watch tripped? (<i>pictures</i>)
	<input type="radio"/> Other (specify below)	

Is there a replacement PO?	<input type="radio"/> Yes <input type="radio"/> No	
<i>If yes -> PO #</i>		
<i>If yes -> Date PO placed</i>		
Purchase order number		
BINDER model number		
BINDER serial number		
Date unit was received		
Was the unit unboxed?	<input type="radio"/> Yes <input type="radio"/> No	
Was the unit plugged in?	<input type="radio"/> Yes <input type="radio"/> No	
Was the unit in operation?	<input type="radio"/> Yes <input type="radio"/> No	
<i>Pictures of unit attached?</i>	<input type="radio"/> Yes <input type="radio"/> No	Pictures have to be attached!
<i>Pictures of Packaging attached?</i>	<input type="radio"/> Yes <input type="radio"/> No	

	Customer Contact Information	Distributor Contact Information
Name		
Company		
Address		
Phone		
E-mail		

Customer (End User) Decontamination Declaration

Health and Hazard Safety declaration

To protect the health of our employees and the safety at the workplace, we require that this form is completed by the user for all products and parts that are returned to us. (Distributors or Service Organizations cannot sign this form)



NO RMA number will be issued without a completed form. Products or parts returned to our NY warehouse without a RMA number will be refused at the dock.

A second copy of the completed form must be attached to the outside of the shipping box.

1.	Unit/ component part / type:
2.	Serial No.
3.	List any exposure to hazardous liquids, gasses or substances and radioactive material
3.1	List with MSDS sheets attached where available or needed (if there is not enough space available below, please attach a page):
a)	_____
b)	_____
c)	_____
3.2	Safety measures required for handling the list under 3.1
a)	_____
b)	_____
c)	_____
3.3	Measures to be taken in case of skin contact or release into the atmosphere:
a)	_____
b)	_____
c)	_____
d)	_____
3.4	Other important information that must be considered:
a)	_____
b)	_____
c)	_____

4. Declaration of Decontamination

For toxic, radioactive, biologically and chemically harmful or hazardous substances, or any other hazardous materials.

We hereby guarantee that

- 4.1 Any hazardous substances, which have come into contact with the above-mentioned equipment / component part, have been completely listed under item 3.1 and that all information in this regard is complete.
- 4.2 That the unit /component part has not been in contact with radioactivity
- 4.3 Any Hazardous substances were removed from the unit / component part, so that no hazard exists for a persons in the shipping, handling or repair of these returned unit
- 4.4 The unit was securely packaged in the original undamaged packaging and properly identified on the outside of the packaging material with the unit designation, the RMA number and a copy of this declaration.
- 4.5 Shipping laws and regulations have not been violated.

I hereby commit and guarantee that we will indemnify BINDER Inc. for all damages that are a consequence of incomplete or incorrect information provided by us, and that we will indemnify and hold harmless BINDER Inc. from eventual damage claims by third parties.

Name: _____

Position: _____

Company: _____

Address: _____

Phone #: _____

Email: _____

Date: _____

Signature: _____



Equipment returned to the NY warehouse for repair must be accompanied by a completed customer decontamination declaration. For service and maintenance works on site, such a customer decontamination declaration must be submitted to the service technician before the start of work. No repair or maintenance of the equipment is possible without a completed form.